

DVP-NS300

RMT-D126A/D126E/D126P

SERVICE MANUAL

Self Diagnosis
Supported model



Photo: Titanium gray type

US Model
Canadian Model
AEP Model
UK Model
E Model
Australian Model
PX Model
Russian Model
Brazil Model
Mexico Model
Argentina Model
Malaysia Model
Saudi Arabia Model
Hong Kong Model
Korea Model
Singapore Model
Taiwan Model

SPECIFICATIONS

System

Laser Semiconductor laser
Signal format system NTSC
PAL (EXCEPT US, AR, BR, CND, E32, MX, PX)

Audio characteristics

Frequency response DVD (PCM 96 kHz): 2 Hz to 44 kHz (± 1.0 dB)
DVD (PCM 48 kHz): 2 Hz to 22 kHz (± 0.5 dB)
CD: 2 Hz to 20 kHz (± 0.5 dB)
Signal-to-noise ratio (S/N ratio) 115 dB (LINE OUT L/R (AUDIO) jacks only)
Harmonic distortion 0.003 %
Dynamic range DVD: 103 dB
CD: 99 dB

Wow and flutter Less than detected value ($\pm 0.001\%$ W PEAK)
The signals from LINE OUT L/R (AUDIO) jacks are measured. When you play PCM sound tracks with a 96 kHz sampling frequency, the output signals from the DIGITAL OUT (COAXIAL and OPTICAL) jacks are converted to 48 kHz sampling frequency.

Outputs

Jack name	Jack type	Maximum output level	Load impedance
DIGITAL OUT (OPTICAL) (EXCEPT AEP, UK, RUS)	Optical output jack	-18 dBm	Wave length: 660 nm
DIGITAL OUT (COAXIAL)	Phono jack	0.5 Vp-p	75 ohms terminated
LINE OUT (AUDIO)	Phono jack	2 Vrms (50 kilohms)	Over 10 kilohms
LINE OUT (VIDEO)	Phono jack	1.0 Vp-p	75 ohms, sync negative
S VIDEO OUT	4-pin mini DIN	Luminance signal: 1.0 Vp-p Colour signal: 0.286 Vp-p (NTSC) 0.3 Vp-p (PAL)	75 ohms, sync negative 75 ohms terminated
COMPONENT VIDEO OUT (Y, Pa, Pb) (EXCEPT AEP, UK, RUS)	Phono jack	Y: 1.0 Vp-p Pa, Pb: 0.7 Vp-p	75 ohms, sync negative 75 ohms terminated

General

Power requirements 110V AC, 60 Hz (TW)
120V AC, 60 Hz (US, CND, MX)
110 to 240V AC, 50/60 Hz (BR, E32, PX)
220V AC, 50/60 Hz (AR, EA, HK, KR)
220 to 240V AC, 50/60 Hz (AEP, UK, AUS, E12, ME, RUS, SP)
12 W
Power consumption See page 3 for further information.
Dimensions (approx.) 430 × 74 × 256 mm (17 × 3 × 10 1/8 in.) (width/height/depth) incl. projecting parts
Mass (approx.) 2.7 kg (5 lb)
Operating temperature 5 °C to 35 °C (41 °F to 95 °F)
Operating humidity 25 % to 80 %

Supplied accessories

- Audio/video cord (pinplug × 3 ↔ pinplug × 3) (1)
- Remote commander (remote) RMT-D126A (1) (US, AR, BR, CND, E32, MX, PX)
RMT-D126E (1) (AUS, E12, EA, ME)
RMT-D126P (1) (AEP, UK, RUS)

- Size AA (R6) batteries (2)
- A plug adaptor is included with some models.

Specifications and design are subject to change without notice.

• Abbreviation

AR : Argentina	KR : Korea
AUS : Australian	ME : Middle East
BR : Brazilian	MX : Mexican
CND : Canadian	RUS : Russian
E12 : 220-240 V AC Area in E	SP : Singapore
E32 : 110-240 V AC Area in E	TW : Taiwan
EA : Saudi Arabia	
HK : Hong Kong	



CD/DVD PLAYER

SONY®

SAFETY CHECK-OUT

After correcting the original service problem, perform the following safety checks before releasing the set to the customer:

1. Check the area of your repair for unsoldered or poorly-soldered connections. Check the entire board surface for solder splashes and bridges.
2. Check the interboard wiring to ensure that no wires are "pinched" or contact high-wattage resistors.
3. Look for unauthorized replacement parts, particularly transistors, that were installed during a previous repair. Point them out to the customer and recommend their replacement.
4. Look for parts which, though functioning, show obvious signs of deterioration. Point them out to the customer and recommend their replacement.
5. Check the line cord for cracks and abrasion. Recommend the replacement of any such line cord to the customer.
6. Check the B+ voltage to see it is at the values specified.
7. Check the antenna terminals, metal trim, "metallized" knobs, screws, and all other exposed metal parts for AC leakage. Check leakage as described below.

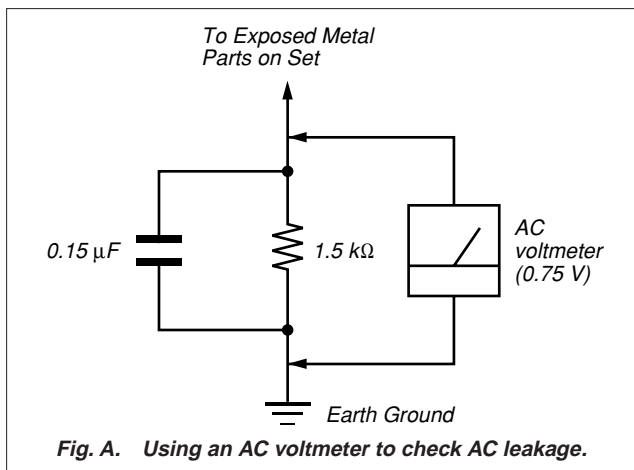

WARNING!!

WHEN SERVICING, DO NOT APPROACH THE LASER EXIT WITH THE EYE TOO CLOSELY. IN CASE IT IS NECESSARY TO CONFIRM LASER BEAM EMISSION, BE SURE TO OBSERVE FROM A DISTANCE OF MORE THAN 25 cm FROM THE SURFACE OF THE OBJECTIVE LENS ON THE OPTICAL PICK-UP BLOCK.

SAFETY-RELATED COMPONENT WARNING!!

COMPONENTS IDENTIFIED BY MARK \triangle OR DOTTED LINE WITH MARK \triangle ON THE SCHEMATIC DIAGRAMS AND IN THE PARTS LIST ARE CRITICAL TO SAFE OPERATION. REPLACE THESE COMPONENTS WITH SONY PARTS WHOSE PART NUMBERS APPEAR AS SHOWN IN THIS MANUAL OR IN SUPPLEMENTS PUBLISHED BY SONY.

LEAKAGE TEST

The AC leakage from any exposed metal part to earth ground and from all exposed metal parts to any exposed metal part having a return to chassis, must not exceed 0.5 mA (500 microamperes). Leakage current can be measured by any one of three methods.

1. A commercial leakage tester, such as the Simpson 229 or RCA WT-540A. Follow the manufacturers' instructions to use these instruments.
2. A battery-operated AC milliammeter. The Data Precision 245 digital multimeter is suitable for this job.
3. Measuring the voltage drop across a resistor by means of a VOM or battery-operated AC voltmeter. The "limit" indication is 0.75V, so analog meters must have an accurate low-voltage scale. The Simpson 250 and Sanwa SH-63Trd are examples of a passive VOM that is suitable. Nearly all battery operated digital multimeters that have a 2V AC range are suitable. (See Fig. A)

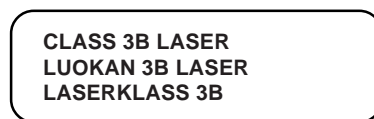
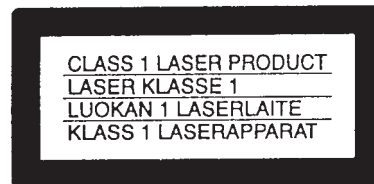
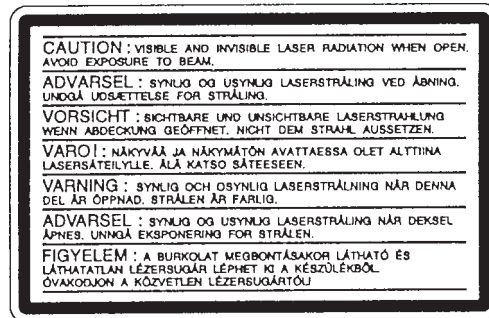

CAUTION:

The use of optical instrument with this product will increase eye hazard.

CAUTION

Use of controls or adjustments or performance of procedures other than those specified herein may result in hazardous radiation exposure.

ATTENTION AU COMPOSANT AYANT RAPPORT À LA SÉCURITÉ!

LES COMPOSANTS IDENTIFIÉS PAR UNE MARQUE \triangle SUR LES DIAGRAMMES SCHÉMATIQUES ET LA LISTE DES PIÈCES SONT CRITIQUES POUR LA SÉCURITÉ DE FONCTIONNEMENT. NE REMPLACER CES COMPOSANTS QUE PAR DES PIÈCES SONY DONT LES NUMÉROS SONT DONNÉS DANS CE MANUEL OU DANS LES SUPPLÉMENTS PUBLIÉS PAR SONY.

TABLE OF CONTENTS

<u>Section</u>	<u>Title</u>	<u>Page</u>	<u>Section</u>	<u>Title</u>	<u>Page</u>
Service Note		4			
1. GENERAL					
Getting Started		1-3		ER-14 (EURO AV) Schematic Diagram (AEP, UK, RUS)	4-41
Hookups		1-3		HS13S0E Printed Wiring Board (AEP, UK, AR, AUS, E12, EA, HK, KR, ME, RUS, SP)	4-43
Playing Discs		1-6		HS13S0E Schematic Diagram (AEP, UK, AR, AUS, E12, EA, HK, KR, ME, RUS, SP)	4-45
Searching for a Scene		1-8		HS13S0F Printed Wiring Board (BR, E32, PX)	4-47
Viewing Information About the Disc		1-9		HS13S0F Schematic Diagram (BR, E32, PX)	4-49
Sound Adjustments		1-10		HS13S0U Printed Wiring Board (US, CND, MX, TW) ..	4-51
Enjoying Movies		1-10		HS13S0U Schematic Diagram (US, CND, MX, TW)	4-53
Using Various Additional Functions		1-11		TOP-244U Printed Wiring Board (US, CND, MX)	4-55
Settings and Adjustments		1-13		TOP-244U Schematic Diagram (US, CND, MX)	4-57
Additional Information		1-14			
2. DISASSEMBLY			5. IC PIN FUNCTION DESCRIPTION		
2-1. Case Removal		2-1	5-1. System Control Pin Function (MB-98 Board IC103)		5-1
2-2. MB-98 Board Removal		2-1			
2-3. ER-14 Board Removal (AEP, UK, RUS)		2-1	6. TEST MODE		
2-4. Rear Panel Removal		2-1	6-1. General Description		6-1
2-5. AV-56 Board Removal		2-2	6-2. Starting Test Mode		6-1
2-6. Tray Cover Removal		2-2	6-3. Syscon Diagnosis		6-1
2-7. Front Panel Removal		2-2	6-4. Drive Auto Adjustment		6-5
2-8. Power Block Removal		2-2	6-5. Drive Manual Operation		6-7
2-9. Mechanism Deck Removal		2-3	6-6. Mecha Aging		6-10
2-10. Tray Removal		2-3	6-7. Emergency History		6-10
2-11. Loading Motor (M001), MS-81 Board Removal		2-3	6-8. Version Information		6-11
2-12. Optical Pick-up Removal		2-3	6-9. Video Level Adjustment		6-11
2-13. IF-80 Board Removal		2-4	6-10. IF CON Self Diagnostic Function		6-11
2-14. Internal Views		2-5	6-11. Troubleshooting		6-18
2-15. Circuit Boards Location		2-6			
3. BLOCK DIAGRAMS			7. ELECTRICAL ADJUSTMENT		
3-1. Overall Block Diagram		3-1	7-1. Power Supply Check		7-1
3-2. RF/Servo Block Diagram		3-3	1. HS13S0E/HS13S0F/HS13S0U/TOP-244U Boards		7-1
3-3. Signal Processor Block Diagram		3-5	7-2. Adjustment of Video System		7-2
3-4. System Control Block Diagram		3-7	1. Video Level Adjustment		7-2
3-5. Video Block Diagram		3-9	2. Checking S Video Output S-Y		7-2
3-6. Audio Block Diagram		3-11	3. Checking S Video Output S-C		7-2
3-7. Interface Control Block Diagram		3-13	4. Checking Component Video Output Y		7-2
3-8. Power 1 Block Diagram		3-15	5. Checking Component Video Output B-Y		7-3
3-9. Power 2 Block Diagram		3-17	6. Checking Component Video Output R-Y		7-3
3-10. Power 3 Block Diagram		3-19	7. Checking RGB Output R		7-3
4. PRINTED WIRING BOARDS AND SCHEMATIC DIAGRAMS			8. Checking RGB Output G		7-3
4-1. Frame Schematic Diagram		4-3	9. Checking RGB Output B		7-4
4-2. Printed Wiring Boards and Schematic Diagrams		4-5	7-3. Adjustment Related Parts Arrangement		7-6
MS-81 (LOADING) Printed Wiring Board and Schematic Diagram		4-5			
MB-98 Printed Wiring Board		4-7	8. REPAIR PARTS LIST		
MB-98 (RF AMP, SERVO) Schematic Diagram		4-11	8-1. Exploded Views		8-1
MB-98 (ARP, SERVO DSP) Schematic Diagram		4-13	8-1-1. Case Assembly		8-1
MB-98 (AV DECODER) Schematic Diagram		4-15	8-1-2. Chassis Assembly		8-3
MB-98 (BNR) Schematic Diagram		4-17	8-1-3. Mechanism Deck Assembly		8-5
MB-98 (DRIVE) Schematic Diagram		4-19	8-2. Electrical Parts List		8-6
MB-98 (SYSTEM CONTROL) Schematic Diagram		4-21			
MB-98 (CLOCK GENERATOR) Schematic Diagram		4-23	• Abbreviation		
MB-98 (AUDIO DSP, D/A CONVERTER) Schematic Diagram		4-25	AR : Argentina		
AV-56 Printed Wiring Board		4-29	AUS : Australian		
AV-56 (VIDEO BUFFER) Schematic Diagram		4-31	BR : Brazilian		
AV-56 (AUDIO AMP) Schematic Diagram		4-33	CND : Canadian		
IF-80 Printed Wiring Board		4-35	E12 : 220-240 V AC Area in E		
IF-80 (IF CON) Schematic Diagram		4-37	E32 : 110-240 V AC Area in E		
ER-14 Printed Wiring Board (AEP, UK, RUS)		4-39	EA : Saudi Arabia		
			HK : Hong Kong		
			KR : Korea		
			ME : Middle East		
			MX : Mexican		
			RUS : Russian		
			SP : Singapore		
			TW : Taiwan		

SERVICE NOTE

1. DISASSEMBLY

- This set can be disassembled in the order shown below.

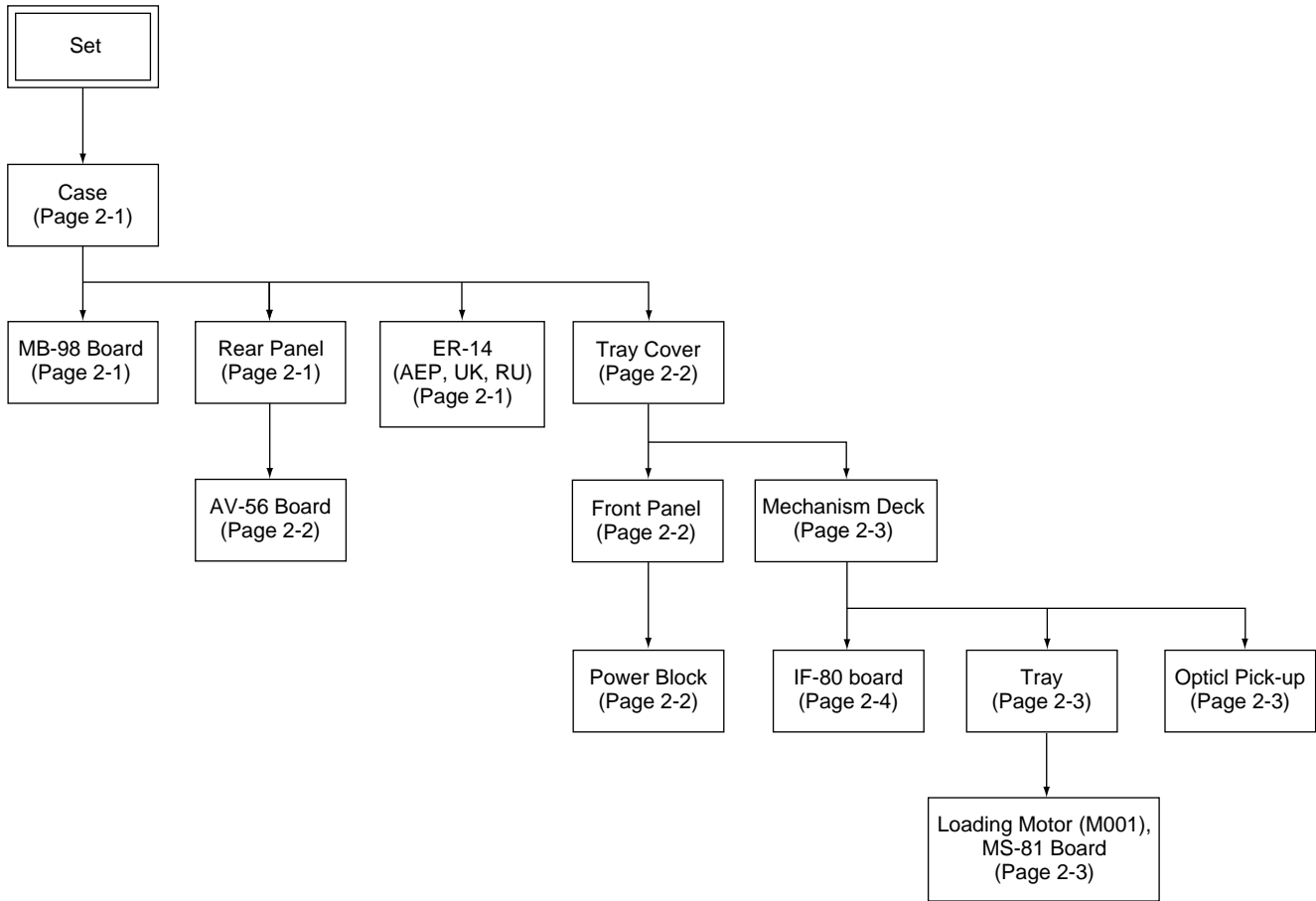

2. DISC REMOVAL PROCEDURE (at POWER OFF)

- 1) Insert a tapering driver into the aperture of the unit bottom, and move the lever of chuck cam in the direction of the arrow **(A)**. (See Fig. 1)
- 2) Draw out the tray in the direction of the arrow **(B)**, and remove a disc. (See Fig. 1)

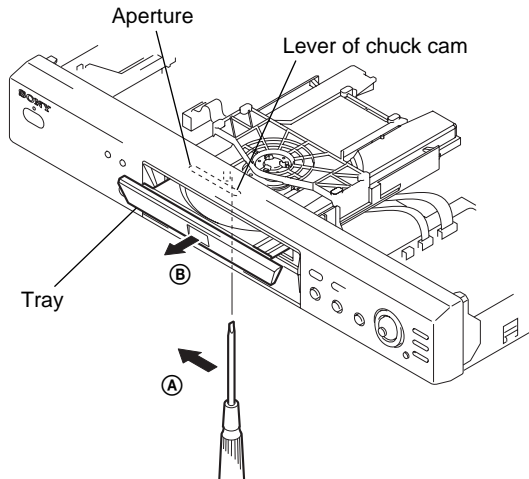
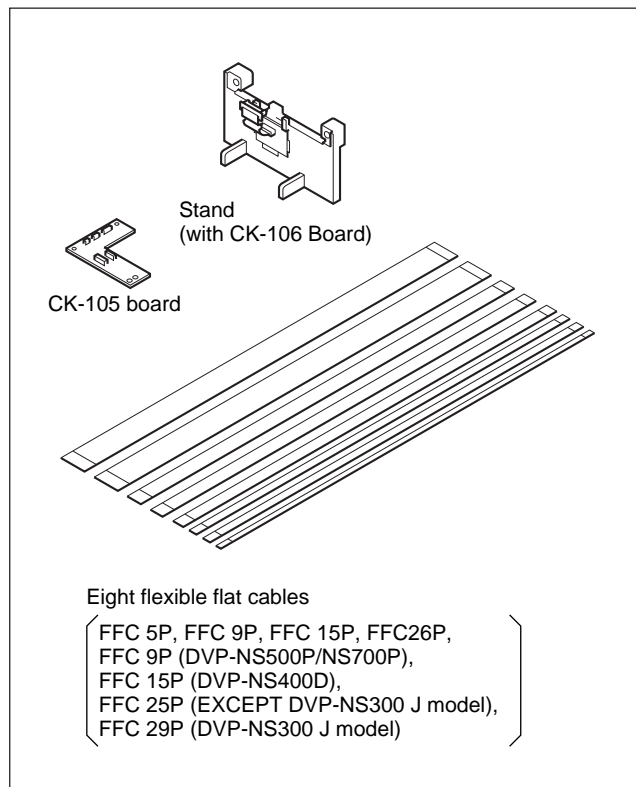

Fig. 1

3. HOW TO SERVICE MB-98 BOARD

- Jig (J-6090-107-A) Extension cable



- 1) Remove the case from the set. (Refer to 2-1)
- 2) Remove the MB-98 board. (Refer to 2-1)
- 3) Set the stand (with CK-106 board) as shown in Fig. 2.

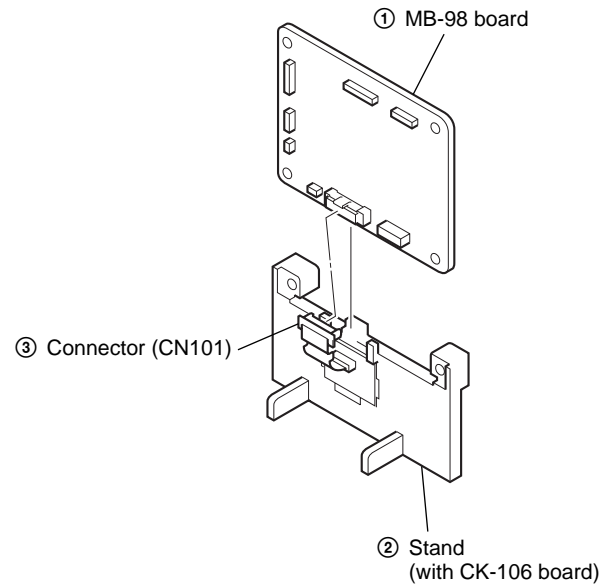

Fig. 2

- 4) Set the Jig A board as shown in Fig. 3.

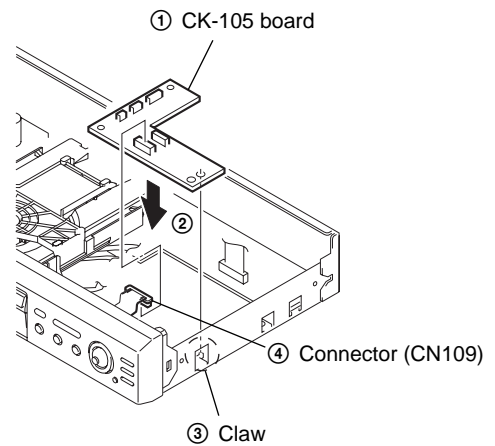

Fig. 3

5) Set the four flexible flat cables as shown in Fig. 4.

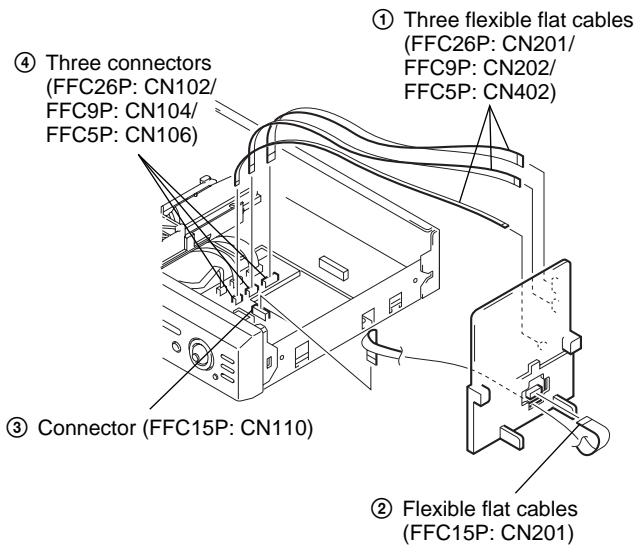

Fig. 4

6) Set the MB-98 board as shown in Fig. 5, Fig.6.

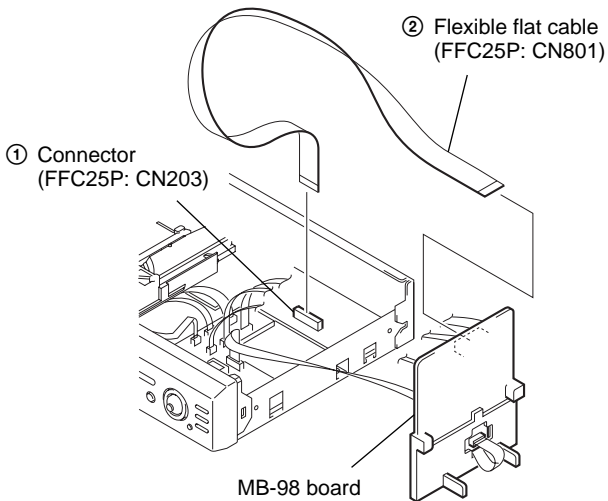

Fig. 5

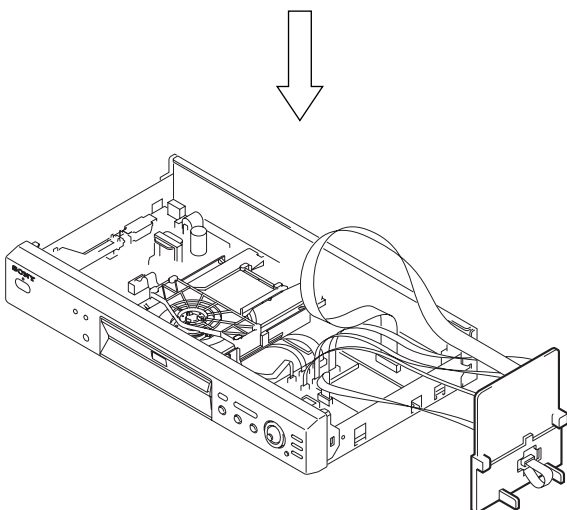
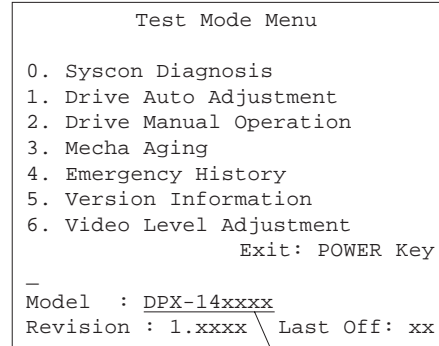

Fig. 6

4. HOW TO DISCRIMINATE MODEL TYPES IN AEP MODEL

1) Start up the test mode, display "Test Mode Menu" as shown below on the monitor, and confirm the model name.



2) Confirm the model type with the menu "2-4 Model Type" in the test mode, then discriminate the model with referring the table shown below. (Refer to page 6-2 to confirm "2-4 Model Type")

	Model Type		Model Display
AEP (DPX1401BM)	0	3	DPX-1401CE
AEP (DPX1401HM)	0	3	DPX-1401CE
AEP (DPX1402BM)	0	4	DPX-1402CE
AEP (DPX1402HM)	0	4	DPX-1402CE

- Description about model name
 DPX14xxBM
 └─ Color of set
 B : Black
 H : Titanium gray

5. CONNECTION OF SERVICE JIG

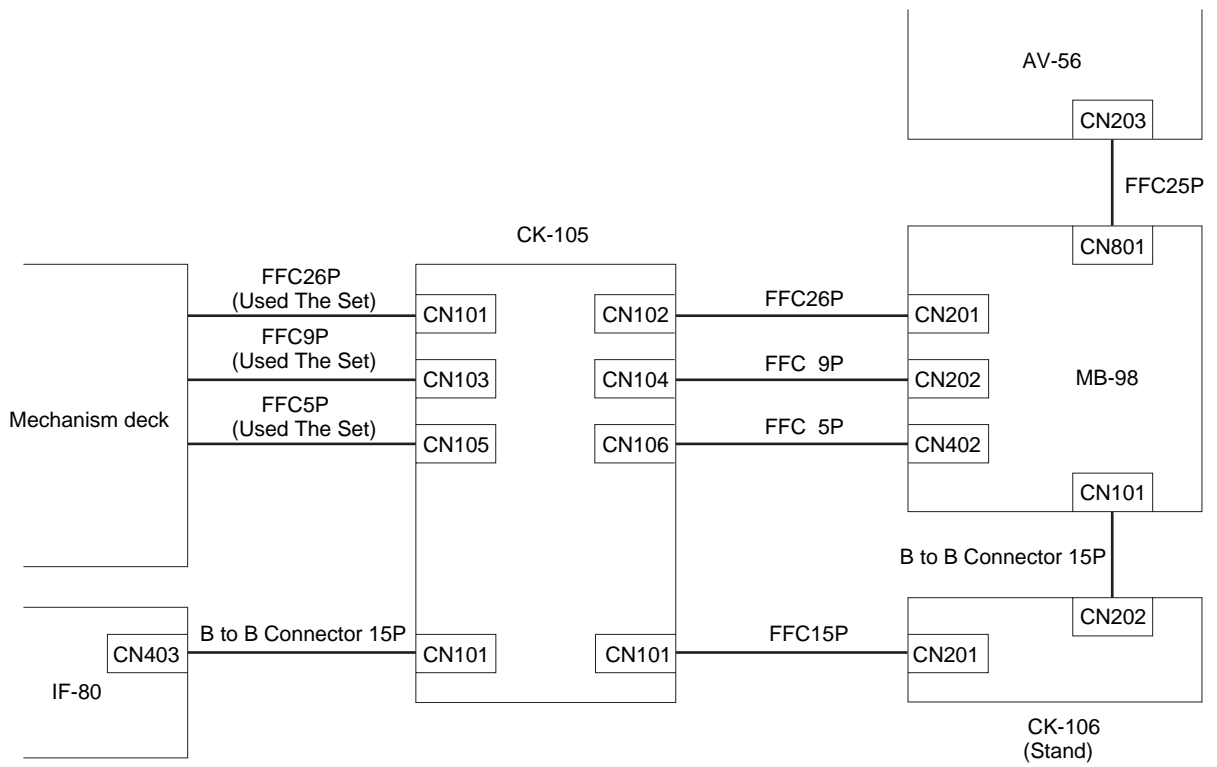

SECTION 1 GENERAL

This section is extracted from instruction manual (3-067-116-11).

About this Manual

- Instructions in this manual describe the controls on the remote. You can also use the controls on the player if they have the same or similar names as those on the remote.
- The icons used in this manual are described below:

Icon	Meaning	Icon	Meaning
	Functions available in DVD video mode		Functions available in music CD mode
	Functions available in VIDEO CD mode		More convenient features

This Player Can Play the Following Discs

Format of discs	
DVD VIDEO	
VIDEO CD	
Music CD	

The "DVD VIDEO" logo is a trademark.

Region code

Your DVD player has a region code printed on the back of the unit and will only play DVDs labeled with identical region codes.

DVDs labeled will also play on this player.

If you try to play any other DVD, the message "Playback prohibited by area limitations." will appear on the TV screen. Depending on the DVD, no region code indication may be labeled even though playing the DVD is prohibited by area restrictions.



Example of discs that the player cannot play

The player cannot play the following discs:

- CD-ROMs (PHOTO CDs included)
- CD-Rs
- Data part of CD-Extras
- DVD-ROMs
- DVD Audio discs
- HD layer on SACDs

Also, the player cannot play the following discs:

- A DVD with a different region code (page 64).
- A disc recorded in a color system other than NTSC, such as PAL or SECAM. (This player conforms to the NTSC color system.)
- A disc that has a non-standard shape (e.g., card, heart).
- A disc with paper or stickers on it.
- A disc that has the adhesive of cellophane tape or a sticker still left on it.

Note on playback operations of DVDs and VIDEO CDs

Some playback operations of DVDs and VIDEO CDs may be intentionally set by software producers. Since this player plays DVDs and VIDEO CDs according to the disc contents the software producers designed, some playback features may not be available. Also, refer to the instructions supplied with the DVDs or VIDEO CDs.

Copyrights

This product incorporates copyright protection technology that is protected by method claims of certain U.S. patents, other intellectual property rights owned by Macrovision Corporation, and other rights owners. Use of this copyright protection technology must be authorized by Macrovision Corporation, and is intended for home and other limited viewing uses only unless otherwise authorized by Macrovision Corporation. Reverse engineering or disassembly is prohibited.

Notes about the Discs

On handling discs

- To keep the disc clean, handle the disc by its edge. Do not touch the surface.



- Do not expose the disc to direct sunlight or heat sources such as hot air ducts, or leave it in a car parked in direct sunlight as the temperature may rise considerably inside the car.
- After playing, store the disc in its case.

On cleaning

- Before playing, clean the disc with a cleaning cloth.
- Wipe the disc from the center out.



- Do not use solvents such as benzene, thinner, commercially available cleaners, or anti-static spray intended for vinyl LPs.

Index to Parts and Controls

For more information, refer to the pages indicated in parentheses.

Front Panel

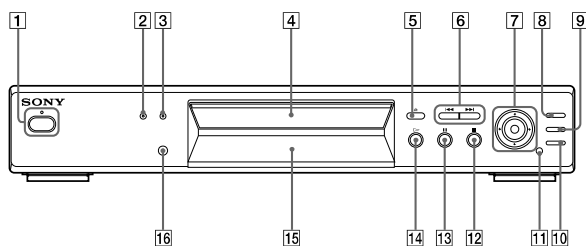

- | | |
|---|----------------------------|
| 1 POWER switch/indicator (28) | 10 RETURN button (32) |
| 2 BNR (Block Noise Reduction) button/indicator (46) | 11 DISPLAY button (12) |
| 3 SURROUND button/indicator (43) | 12 (stop) button (28) |
| 4 Disc tray (28) | 13 (pause) button (29, 52) |
| 5 (open/close) button (28) | 14 (play) button (28) |
| 6 (previous/next) buttons (29) | 15 Front panel display (9) |
| 7 (stop/enter) buttons (24) | 16 (remote sensor) (14) |
| 8 TITLE button (31) | |
| 9 DVD MENU button (31) | |

Front Panel Display

When playing back a DVD

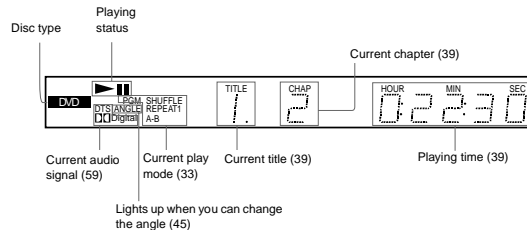

When playing back a VIDEO CD (PBC)

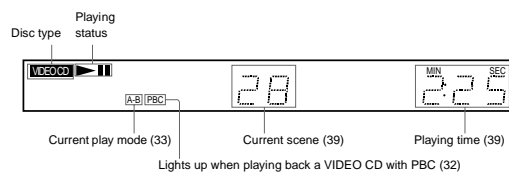

When playing back a CD or VIDEO CD (without PBC)

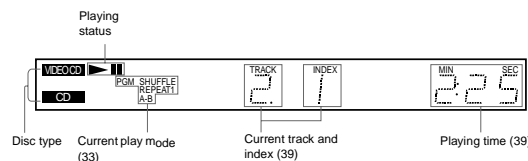

Rear panel

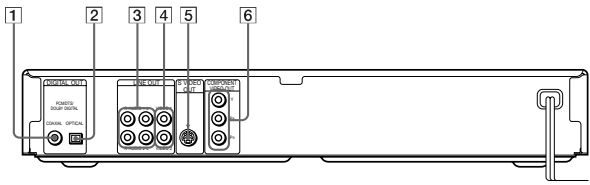

- 1 DIGITAL OUT (COAXIAL) jack (21, 22, 23)
- 2 DIGITAL OUT (OPTICAL) jack (21, 22, 23)
- 3 LINE OUT L/R (AUDIO) 1/2 jacks (20, 21, 22)
- 4 LINE OUT (VIDEO) 1/2 jacks (17)
- 5 S VIDEO OUT jack (17)
- 6 COMPONENT VIDEO OUT jacks (17)

Remote

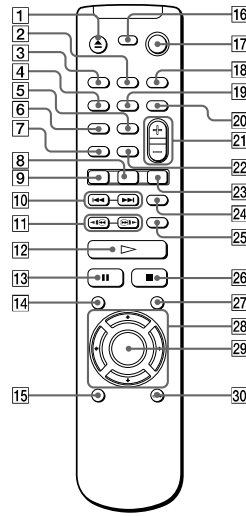

- 1 ▲ OPEN/CLOSE button (28)
- 2 BNR (Block Noise Reduction) button (46)
- 3 SURROUND button (43)
- 4 TIME/TEXT button (39)
- 5 REPEAT button (35)
- 6 SHUFFLE button (35)
- 7 PROGRAM button (35)
- 8 ANGLE button (45)
- 9 AUDIO button (42)
- 10 ◀◀▶▶ PREV/NEXT buttons (29)
- 11 ◀◀▶▶ SCAN/SLOW buttons (37)
- 12 ▶ PLAY button (28)
- 13 ■ PAUSE button (28)
- 14 TITLE button (31)
- 15 DISPLAY button (54)
- 16 TV I/O (on/standby) button (53)
- 17 I/O (on/standby) button (53)
- 18 SETUP button (54)
- 19 A - B button (36)
- 20 TV/VIDEO button (53)
- 21 VOL +/- button (53)
- 22 CLEAR button (33)
- 23 SUBTITLE button (45)
- 24 SEARCH MODE button (38)
- 25 INSTANT REPLAY button (53)
- 26 ■ STOP button (28)
- 27 DVD MENU button (31)
- 28 ◀/▶/◀/▶ buttons (24)
- 29 ENTER button
- 30 ↻ RETURN button (32)

Guide to On-Screen Displays (Status Bar, Control Bar, Control Menu)

The following explains the three type of on-screen displays used with this player: Status Bar, and Control Bar, and Control Menu.

Status Bar

Displays the current playing status. This display appears when the DISPLAY button is pressed repeatedly during playback. The numbers in parentheses indicate reference pages.

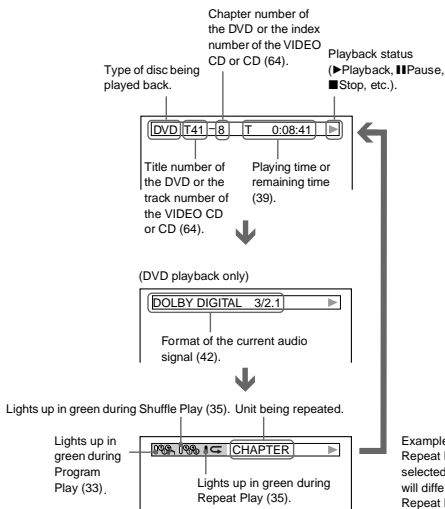

Control Bar

The Control Bar appears when a playback function is selected by pressing the function's button on the remote.

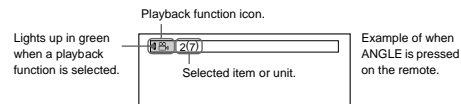

Control Menu

The Control Menu appears when the DISPLAY button is pressed when the player is in stop mode. The number in parenthesis indicate reference pages.

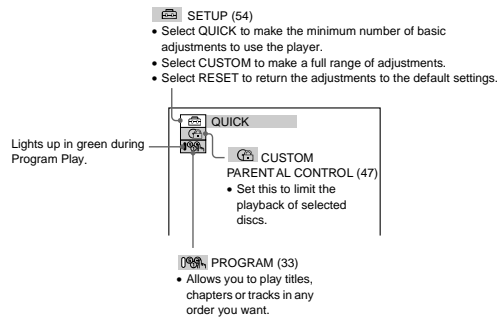

Quick Overview

A quick overview presented in this chapter will give you enough information to start using the player for your enjoyment. To use the surround sound features of this player, refer to "Hookups" on page 17.

Note

You cannot connect this player to a TV that does not have a video input jack. Be sure to turn off the power of each component before connecting.

Step 1: Unpacking

Check that you have the following items:

- Audio/video cord (pinplug × 3 ↔ pinplug × 3) (1)
- Remote commander (remote) RMT-D126A (1)
- Size AA (R6) batteries (2)
- A plug adaptor is included with some models.

Step 2: Inserting Batteries into the Remote

You can control the player using the supplied remote. Insert two size AA (R6) batteries by matching the ⊕ and ⊖ ends on the batteries to the markings inside the compartment. When using the remote, point it at the remote sensor  on the player.

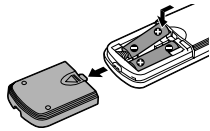

Notes



- Do not leave the remote in an extremely hot or humid place.
- Do not drop any foreign object into the remote casing, particularly when replacing the batteries.
- Do not expose the remote sensor to direct light from the sun or lighting apparatus. Doing so may cause a malfunction.
- If you do not use the remote for an extended period of time, remove the batteries to avoid possible damage from battery leakage and corrosion.

14

Step 4: Playing a Disc

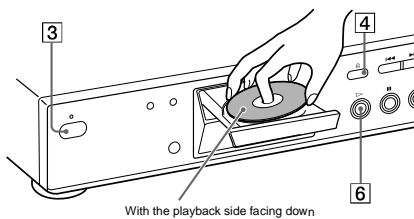
- 1 Turn on the TV.
- 2 Switch the input selector on the TV to the player.



- 3 Press POWER on the player.
- 4 Press  on the player to open the disc tray.
- 5 Place the disc on the tray with the playback side facing down.
- 6 Press . The disc tray closes and the player begins playing the disc.

After Step 6

Depending on the disc, a menu may be displayed on the TV screen. If so, select the item you want from the menu and play the DVD (page 31) or VIDEO CD disc (page 32).

To stop playing

Press .

To take out the disc

Press .

To turn off the player

Press  on the remote. The player is set to standby mode and the power indicator lights up in red. Press POWER on the player to turn off completely.

16

Step 3: TV Hookups

Connect the supplied audio/video cord and power cord in the order (1)-(3) shown below. Be sure to connect the power cord last.

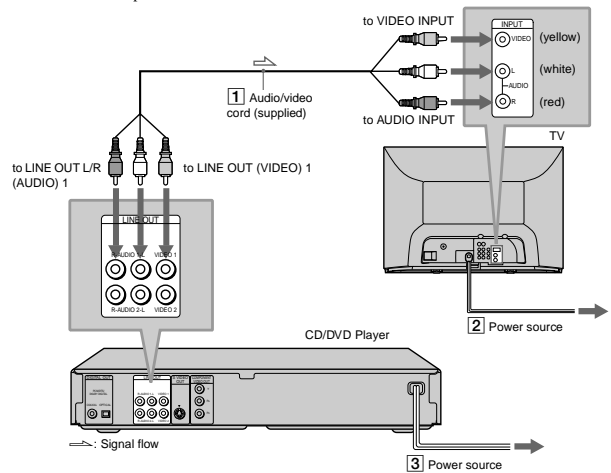

When connecting to a wide screen TV

Depending on the disc, the image may not fit your TV screen. If you want to change the aspect ratio, please refer to page 56.

15

Hookups

Hooking Up the Player

Follow Steps 1 to 4 to hook up and adjust the settings of the player. Before you start, turn off the power, check that you have all of the supplied accessories, and insert the batteries into the remote (page 14).

Notes

- Plug cords securely to prevent unwanted noise.
- Refer to the instructions supplied with the components to be connected.

Step 1: Connecting the Video Cords

Connect your CD/DVD player to your TV monitor, projector, or AV amplifier (receiver) using a video cord. Select one of the patterns A through C, according to the input jack on your TV monitor, projector, or AV amplifier (receiver).

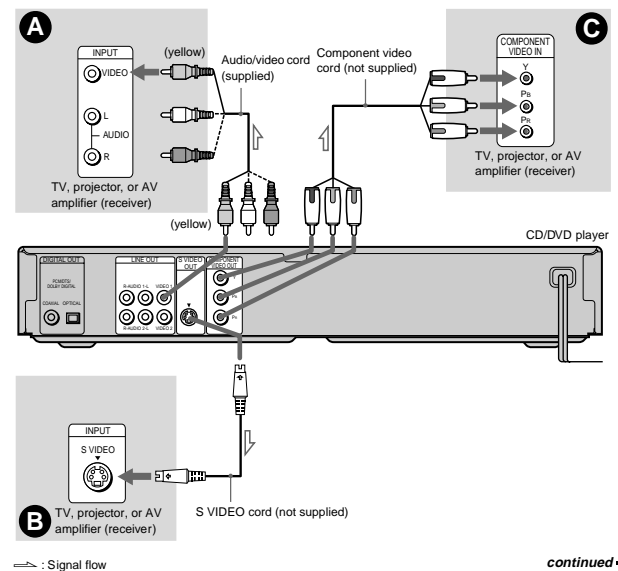

continued

17

A If you are connecting to a video input jack

Connect the yellow plug of the audio/video cord (supplied) to the yellow (video) jacks. You will enjoy standard quality images.

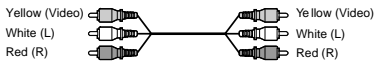

Use the red and white plugs to connect to the audio input jacks (page 19).

B If you are connecting to an S VIDEO input jack

Connect the S VIDEO cord (not supplied). You will enjoy high quality images.



C If you are connecting to a monitor, projector, or AV amplifier (receiver) having component video input jacks (Y, Pb, Pr)

Connect the component via the COMPONENT VIDEO OUT jacks using a component video cord (not supplied) or three video cords (not supplied) of the same kind and length. You will enjoy accurate color reproduction and high quality images.

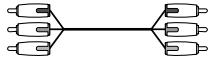

Note

Do not connect your player to a VCR. You may not receive a clear image on the TV screen if you pass the player signals via the VCR.

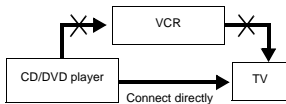

Step 2: Connecting the Audio Cords

Refer to the chart below to select the connection that best suits your system. The surround effects you will enjoy depend on the connections and components you use.

Select a connection

Select one of the following connections, **A** through **D**.

Connection	Components to be connected
A (page 20)	• TV (stereo)
B (page 21)	• Stereo amplifier (receiver) (having L and R audio input jacks only, or having a digital input jack) • 2 speakers (front L and R)
B (page 21)	• MD deck/DAT deck
C (page 22)	• AV amplifier (receiver) with a Dolby® Surround (Pro Logic) decoder (having L and R audio input jacks only, or having a digital input jack) • 3 speakers (front L and R, and rear (monaural)) • 6 speakers (front L and R, center, rear L and R, and subwoofer)
D (page 23)	• AV amplifier (receiver) having a Dolby Digital or DTS** decoder and a digital input jack • 6 speakers (front L and R, rear L and R, center, and subwoofer)

* Manufactured under license from Dolby Laboratories. "Dolby," "Pro Logic," and the double-D symbol are trademarks of Dolby Laboratories. Confidential unpublished works. © 1992-1997 Dolby Laboratories. All rights reserved.

** "DTS" is a registered trademark of Digital Theater Systems, Inc.

Hookups

A Connecting to your TV

This connection will use your TV speakers for sound.

■ Recommended surround sound effects for this connection

- TVS DYNAMIC (page 43)
- TVS WIDE (page 43)

CD/DVD player

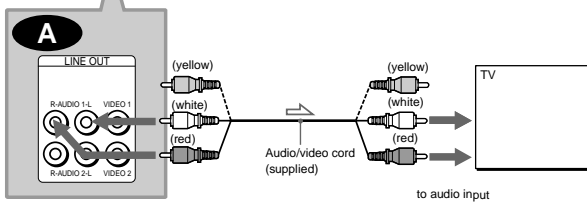
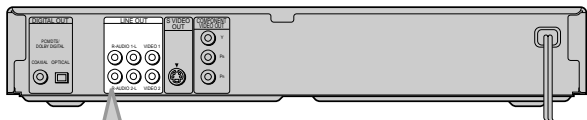

→: Signal flow

The yellow plug is used for video signals (page 17).

B Connecting to a stereo amplifier (receiver) and 2 speakers/Connecting to an MD deck or DAT deck

This connection will use your 2 front speakers connected to your stereo amplifier (receiver) for sound. If the stereo amplifier (receiver) has audio input jacks L and R only, use **B-1**. If the amplifier (receiver) has a digital input jack, use **B-2**. When connecting to an MD deck or a DAT deck, use **B-2**. In this case, you can also connect the player directly to the MD deck or DAT deck without using your stereo amplifier (receiver).

■ Recommended surround sound effects for the **B-1** connection only

- TVS STANDARD (page 43)

💡 In connection **B-1**, you can use the supplied audio/video cord instead of using a separate audio cord.

💡 To realize better surround sound effects, make sure that your listening position is in between your speakers.

Note

If you select one of the TVS effects while playing a disc, no sound will come from your speakers with the **B-2** connection.

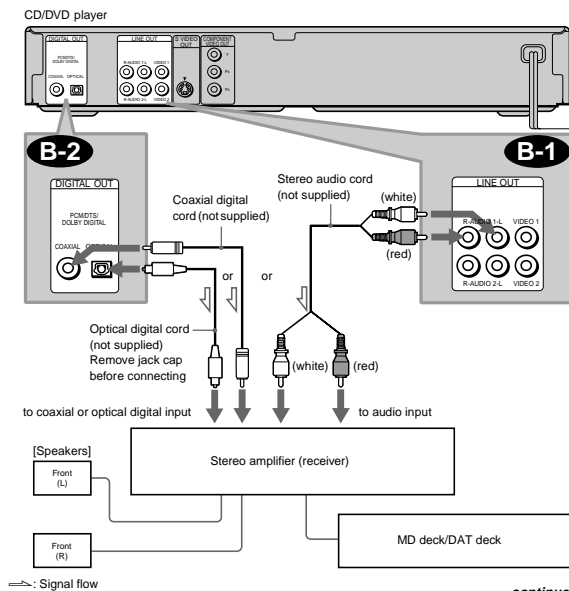

→: Signal flow

Hookups

C Connecting to a Dolby Surround (Pro Logic) decoder amplifier (receiver) and 3 to 6 speakers

This connection will allow you to enjoy the surround effects of the Pro Logic decoder on your amplifier (receiver). If you have an AV amplifier (receiver) equipped with a Dolby Digital, or DTS decoder, refer to page 23. You can enjoy the Dolby Surround effects only when playing Dolby Surround audio or multi-channel audio (Dolby Digital) discs. Pro Logic uses a minimum of 3 speakers (front L and R, and rear (monaural)). The surround effects are enhanced if 6 speakers (front L and R, center, rear L and R, and subwoofer) are used. If your amplifier (receiver) has R and L audio input jacks only, use **C-1**. If your amplifier (receiver) has a digital input jack, use **C-2**.

- Recommended surround sound effects using this connection with your amplifier (receiver)
 - Dolby Surround (Pro Logic) (page 64)

For correct speaker setting location, please refer to the operating instructions of the amplifier (receiver).

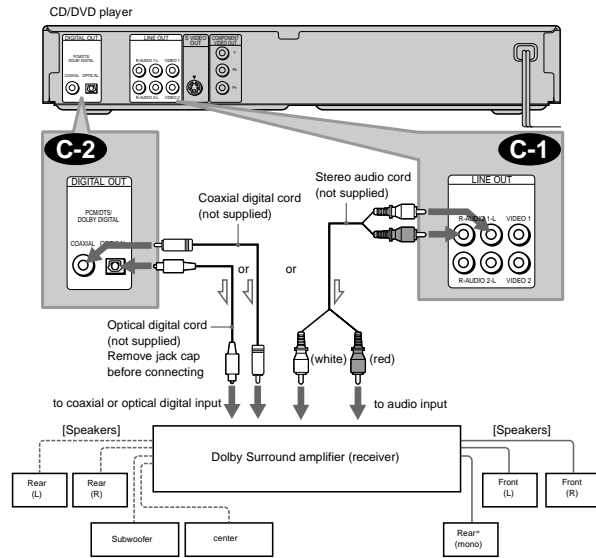

Signal flow

*When connecting 6 speakers, replace the monaural rear speaker with a center speaker, 2 rear speakers and a subwoofer.

Step 3: Connecting the Power Cord

Plug the player and TV power cords into an AC outlet.

Do not connect the power cord of your player to the "switched" power socket of an amplifier (receiver). Otherwise, when you turn off the power of your amplifier (receiver), the settings for the player may be lost.

Step 4: Quick Setup

Follow the steps below to make the minimum number of basic adjustments to use the player. To skip an adjustment, press **▶▶**. To return to the previous adjustment, press **◀◀**.

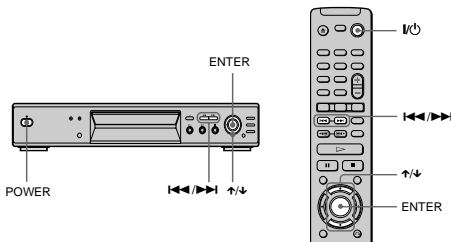

- Turn on the TV.
- Switch the input selector on the TV to the player.
- Press **POWER** on the player and press **I/O** on the remote. "Press [ENTER] to run QUICK SETUP" appears at the bottom of the screen. If this message does not appear, select "QUICK" under SETUP in the Control Menu (page 13) to run Quick Setup.
- Press **ENTER** without inserting a disc. The Setup Display for selecting the language used in the on-screen display appears.

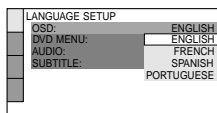

D Connecting to an AV amplifier (receiver) with a digital input jack having a Dolby Digital, or DTS decoder, and 6 speakers

This connection will allow you to use the Dolby Digital, or DTS decoder function of your AV amplifier (receiver). You are not able to enjoy the TVS sound effects of the player.

- Recommended surround sound effects using this connection with your amplifier (receiver)
 - Dolby Digital (5.1ch) (page 64)
 - DTS (5.1ch) (page 64)

To enhance the surround sound effects, refer to the operating instructions of the amplifier (receiver) for correct speaker setting location.

Note

After you have completed the connection, be sure to set "DOLBY DIGITAL" to "DOLBY DIGITAL" (page 24). If your AV amplifier (receiver) has a DTS decoder, set "DTS" to "ON" (page 28). Otherwise, no sound or a loud noise will come from the speakers.

CD/DVD player

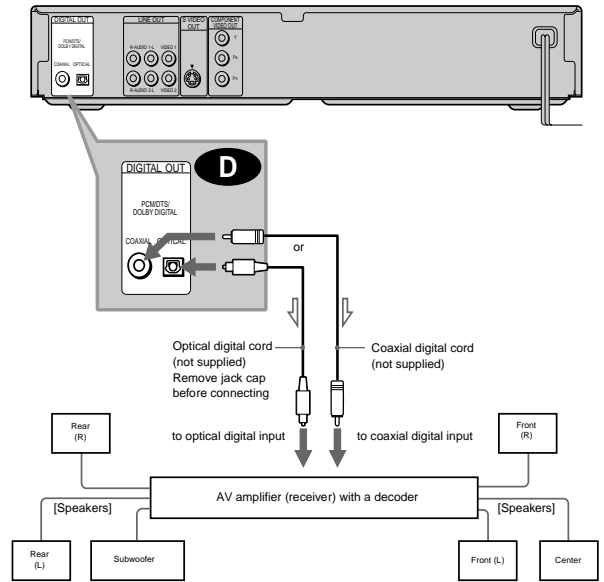

Signal flow

- Press **↑/↓** to select a language. The player uses the language selected here to display the DVD menu and subtitles as well.
- Press **ENTER**. The Setup Display for selecting the aspect ratio of the TV to be connected appears.

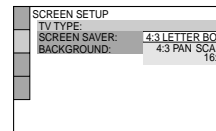

- Press **↑/↓** to select the item.

TV type	You select	Page
4:3 standard TV	4:3 LETTER BOX or 4:3 PAN SCAN	56
A wide-screen TV or 4:3 standard TV with the wide-screen mode	16:9	56

- Press **ENTER**. The Setup Display for selecting the type of jack used to connect your amplifier (receiver) appears.

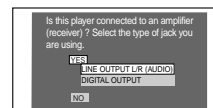

- Press **↑/↓** to select the item, then press **ENTER**.
 - When "NO" or "LINE OUTPUT L/R (AUDIO)" is selected, Quick Setup is finished and connections are complete.
 - When "DIGITAL OUTPUT" is selected, the Setup Display for "DOLBY DIGITAL" appears. Proceed to Step 10.
- Press **↑/↓** to select the item. Choose the item that matches the audio connection you selected in page 21 to 23 (**B** through **D**).

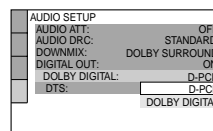

Audio Cord Connection Type	You select	Page
B-2 C-2	D-PCM	59
D	DOLBY DIGITAL (only if the amplifier/receiver has a Dolby Digital decoder)	59

- 11 Press ENTER.
DTS is selected.

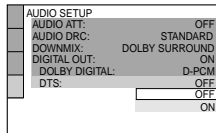

Press \uparrow/\downarrow to select the item.

Choose the item that matches the audio connection you selected in page 21 to 23 (**B** through **D**).

Audio Cord Connection Type	You select	Page
B-2 C-2	OFF	59
D	ON (only if the amplifier/receiver has a DTS decoder)	59

- 13 Press ENTER.
Quick Setup is finished. All connections and setup operations are complete.

Note

You can directly start Quick Setup only when you run it for the first time.
To run Quick Setup a second time, select "QUICK" under SETUP in the Control Menu (page 54).

Enjoying the surround sound effects

To enjoy the surround sound effects of this player or your amplifier (receiver), the following items must be set as described below for the audio connection you selected in page 21 to 23 (**B** through **D**). Each of these are the default settings and do not need to be adjusted when you first connect the player. Refer to page 56 for using the Setup Display.

Audio Connection (page 19 to 23)

- A**
No additional settings are needed.

Item	You select	Page
B-1 C-1	DOLBY SURROUND	58

- If the sound distorts even when the volume is turned down, set "AUDIO ATT" to "ON" (page 58).

Item	You select	Page
B-2 C-2 D	DOLBY SURROUND	58
B-2 C-2 D	ON	59

Playing Discs

Playing Discs

Depending on the DVD or VIDEO CD, some operations may be different or restricted.

Refer to the operating instructions supplied with your disc.

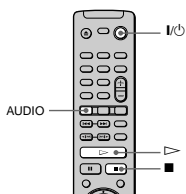
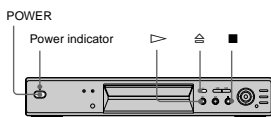

- Turn on your TV.
- Switch the input selector on the TV to the player.
When using an amplifier (receiver)
Turn on the amplifier (receiver) and select the appropriate channel.
- Press POWER on the player.
The player enters standby mode and the power indicator lights up in red.

- 4 Press ⏻ on the player, and place a disc on the disc tray.

The player automatically turns on and the power indicator lights up in green.

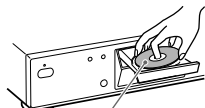

With the playback side facing down

- 5 Press ▶ .

The disc tray closes, and the player starts playback (continuous play). Adjust the volume on the TV or the amplifier (receiver).

After following Step 5

Depending on the disc, a menu may appear on the TV screen. You can play the disc interactively by following the instructions on the menu. DVD (page 31), VIDEO CD (page 32).

To turn on the player

Press the POWER switch on the player. The player enters standby mode and the power indicator lights up in red. Press I/⏻ on the remote. The player turns on and the power indicator lights up in green. In standby mode, the player also turns on by pressing ⏻ on the player or by pressing ▶ .

To turn off the player

Press I/⏻ on the remote. The player enters standby mode and the power indicator lights up in red. To turn off the player completely, press POWER on the player. While playing a disc, do not turn off the player by pressing POWER. Doing so may cancel the menu settings. When you turn off the player, first press ■ to stop playback and then press I/⏻ on the remote

Notes on playing DTS sound tracks on a CD

- When playing DTS-encoded CDs, excessive noise will be heard from the analog stereo jacks. To avoid possible damage to the audio system, the consumer should take proper precautions when the analog stereo jacks of the player are connected to an amplification system. To enjoy DTS Digital Surround™ playback, an external 5.1-channel decoder system must be connected to the digital jacks of the player.
- Set the sound to "STEREO" using the AUDIO button when you play DTS sound tracks on a CD (page 42).
- Do not play DTS sound tracks without first connecting the player to an audio component having a built-in DTS decoder. The player outputs the DTS signal via the DIGITAL OUT (OPTICAL and COAXIAL) jacks even if "DTS" in "AUDIO SETUP" is set to "OFF" in the Setup Display (page 60), and may affect your ears or cause your speakers to be damaged.

Notes on playing DVDs with a DTS sound track

- DTS audio signals are output only through the DIGITAL OUT (OPTICAL and COAXIAL) jacks.
- If you connect the player to audio equipment without a DTS decoder, do not set "DTS" to "ON" in "AUDIO SETUP" (page 59). A loud noise may come out from the speakers, affecting your ears or causing the speakers to be damaged.
- When you play a DVD with DTS sound tracks, set "DTS" to "ON" in "AUDIO SETUP" (page 59).

Additional operations

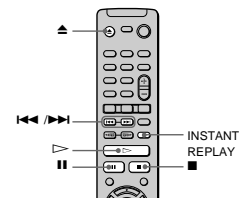

To	Operation
Stop	Press ■
Pause	Press ⏸
Resume play after pause	Press ⏸ or ▶
Go to the next chapter, track or scene in continuous play mode	Press ▶▶
Go back to the preceding chapter, track or scene in continuous play mode	Press ◀◀
Stop play and remove the disc	Press ⏻
Replay a previous scene (DVD only)	Press INSTANT REPLAY

💡 The Instant Replay function is useful when you want to review a scene or dialog that you missed.

Note

You may not be able to use the Instant Replay function with some scenes.

Resuming Playback from the Point Where You Stopped the Disc (Resume Play)



When you stop the disc, the player remembers the point where you pressed ■ and "RESUME" appears on the front panel display. As long as you do not open the disc tray, Resume Play works even if the player enters standby mode by pressing I/O on the remote.

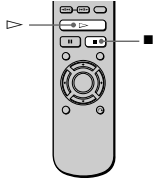

- 1 While playing a disc, press ■ to stop playback.**
"RESUME" appears on the front panel display and you can restart the disc from the point where you stopped the disc.
If "RESUME" does not appear, Resume Play is not available.
- 2 Press ▶.**
The player starts playback from the point where you stopped the disc in Step 1.

To play from the beginning of the disc, press ■ twice, then press ▶.

Notes

- Depending on where you stopped the disc, the player may not resume playback from exactly the same point.
- The point where you stopped playing is cleared when:
 - you turn the power off by pressing the POWER switch on the player.
 - you change the play mode.
 - you change the settings on the Setup Display.

Using the DVD's Menu

Some discs have a "title menu" or a "DVD menu." On some DVDs, this may simply be called a "menu" or "titles."

Using the title menu

A DVD is divided into long sections of a picture or a music feature called "titles." When you play a DVD which contains several titles, you can select the title you want using the title menu.

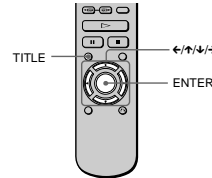

- 1 Press TITLE.**
The title menu appears on the TV screen. The contents of the menu vary from disc to disc.
- 2 Press ←/→ to select the title you want to play.**
- 3 Press ENTER.**
The player starts playing the selected title.

You can also display the title menu by pressing TITLE on the player.

Using the DVD menu

Some DVDs allow you to select the disc contents using a menu. When you play these DVDs, you can select items such as the language for the subtitles and the language for the sound using the DVD menu.

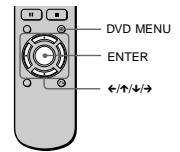

- 1 Press DVD MENU.**
The DVD menu appears on the TV screen. The contents of the menu vary from disc to disc.
- 2 Press ←/→ to select the item you want to change.**
- 3 To change other items, repeat Step 2.**
- 4 Press ENTER.**

You can also display the DVD menu by pressing DVD MENU on the player.

30

Playing VIDEO CDs with PBC Functions (PBC Playback)



With PBC (Playback Control) functions, you can enjoy simple interactive operations, search functions, and other such operations. PBC playback allows you to play VIDEO CDs interactively by following the menu on the TV screen.

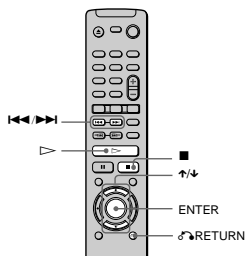

- 1 Start playing a VIDEO CD with PBC functions.**
The menu for your selection appears.
- 2 Select the item number you want by pressing ↑/↓.**
- 3 Press ENTER.**
- 4 Follow the instructions in the menu for interactive operations.**
Refer to the instructions supplied with the disc, as the operating procedure may differ according to the VIDEO CD.

To go back to the menu
Press RETURN.

To play without using PBC, press ←/→ while the player is stopped to select a track, then press → or ENTER. "Play without PBC." appears on the TV screen and the player starts continuous play. You cannot play still pictures such as a menu. To return to PBC playback, press ■ twice then press ▶.

Note

Depending on the VIDEO CD, "Press ENTER" in Step 3 may appear as "Press SELECT" in the instructions supplied with the disc. In this case, press ▶.

Various Play Mode Functions (Program Play, Shuffle Play, Repeat Play, A-B Repeat Play)



- You can set the following play modes:
- Program Play (page 33)
 - Shuffle Play (page 35)
 - Repeat Play (page 35)
 - A-B Repeat Play (page 36)

Notes

- The play mode is cancelled when:
 - you open the disc tray.
 - the player enters standby mode by pressing I/O on the remote.
 - you turn the power off by pressing POWER on the player.
- If you are playing a VIDEO CD with PBC, you must first cancel PBC playback before you can set a play mode (except when you want to set A-B Repeat Play for moving pictures).

Creating your own program (Program Play)

You can play the contents of a disc in the order you want by arranging the order of the titles, chapters or tracks on the disc to create your own program. You can program up to 99 titles, chapters, and tracks.

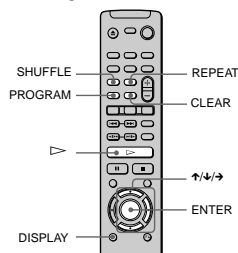

- 1 Press DISPLAY while the player is in stop mode.**
The Control Menu is displayed.
- 2 Press ↑/↓ to select (PROGRAM) and press ENTER.**

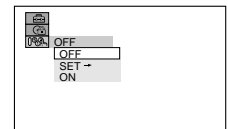

- 3 Press ↑/↓ to select "SET →" and press ENTER.**

The display for programming appears.

Tracks or titles recorded on a disc.

PROGRAM	T
ALL CLEAR	
1. TITLE --	01
2. TITLE --	02
3. TITLE --	03
4. TITLE --	04
5. TITLE --	05
6. TITLE --	06
7. TITLE --	07

"TRACK" is displayed when you play a VIDEO CD or a CD

- 4 Press →.**
The cursor moves to the title or track (in this case, "01").

PROGRAM	T	C
ALL CLEAR		
1. TITLE --	01	ALL
2. TITLE --	02	02
3. TITLE --	03	03
4. TITLE --	04	04
5. TITLE --	05	05
6. TITLE --	06	06
7. TITLE --	07	07

Chapter recorded on a disc

32

31

Playing Discs

32

5 Select the title, chapter, or track you want to program.

■ When playing a DVD

For example, select chapter "03" of title "02".

Press \uparrow/\downarrow to select "02" under "T," then press ENTER.

PROGRAM	T	C
ALL CLEAR	--	ALL
1. TITLE --	01	01
2. TITLE --	02	02
3. TITLE --	03	03
4. TITLE --	04	04
5. TITLE --	05	05
6. TITLE --	06	06

Next, press \uparrow/\downarrow to select "03" under "C," then press ENTER.

PROGRAM	T
ALL CLEAR	--
1. TITLE 02-03	01
2. TITLE --	02
3. TITLE --	03
4. TITLE --	04
5. TITLE --	05
6. TITLE --	06

Selected title and chapter

■ When playing a VIDEO CD or CD

For example, select track "02."

Press \uparrow/\downarrow to select "02" under "T," then press ENTER.

PROGRAM	T	C
ALL CLEAR	--	--
1. TRACK (02)	01	01
2. TRACK --	02	02
3. TRACK --	03	03
4. TRACK --	04	04
5. TRACK --	05	05
6. TRACK --	06	06

Total time of the programmed tracks

6 To program other titles, chapters, or tracks, repeat Steps 4 and 5.

The programmed titles, chapters, and tracks are displayed in the selected order.

2 Press REPEAT repeatedly to select the item you want to set.

■ When playing a DVD (Program Play and Shuffle Play are set to OFF)

- DISC: Repeats all of the titles.
- TITLE: Repeats the current title on a disc.
- CHAPTER: Repeats the current chapter.

■ When playing a VIDEO CD or CD (Program Play and Shuffle Play are set to OFF)

- DISC: Repeats all of the tracks on a disc.
- TRACK: Repeats the current track.

■ When Program Play or Shuffle Play is on

- ON: Repeats Program Play or Shuffle Play.

To return to normal play

Press CLEAR or select "OFF" in Step 2.

💡 You can set the player to "repeat" in stop mode as well. After pressing REPEAT to select the item you want to set, press \triangleright . Repeat Play starts.

Repeating a specific portion (A-B Repeat Play)

You can play a specific portion of a title, chapter, or track repeatedly. (This function is useful when you want to memorize lyrics, etc.)

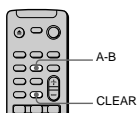

7 Press \triangleright to start Program Play.

Program Play begins.

When the program ends, you can restart the same program again by pressing \triangleright .

To return to normal play

Press CLEAR, or select "OFF" in Step 3. To play the same program again, select "ON" in Step 3 and press \triangleright .

To turn off the Control Menu

Press DISPLAY repeatedly until the Control Menu is turned off.

To change the program

- 1 In Step 4, select the program number of the title, chapter, or track you want to change using \uparrow/\downarrow , and press \rightarrow .
- 2 Follow Step 5 for new programming.

To cancel the programmed order

To cancel all the titles, chapters, or tracks in the programmed order, press \uparrow , and select "ALL CLEAR" in Step 4. To cancel the selected program, select the program using \uparrow/\downarrow in Step 4, then press CLEAR, or select "--" in Step 5, then press ENTER.

💡 You can do Repeat Play or Shuffle Play of the programmed titles, chapters, or tracks by pressing REPEAT or SHUFFLE during Program Play.

💡 You can select "PROGRAM" directly by pressing PROGRAM.

Note

The number of titles, chapters, or tracks displayed are the same number of titles, chapters, or tracks recorded on a disc.

Playing in random order (Shuffle Play)

You can have the player "shuffle" titles, chapters, or tracks and play them in a random order. Subsequent "shuffling" may produce a different playing order.

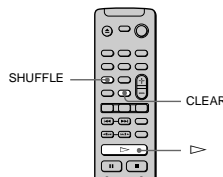

1 Press SHUFFLE during playback.

The Control Bar is displayed.

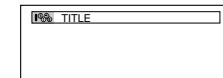

2 Press SHUFFLE repeatedly to select the item you want to set.

■ When playing a DVD (Program Play is set to OFF)

- TITLE: Shuffles titles and plays them in random order.
- CHAPTER: Shuffles chapters and plays them in random order.

■ When playing a VIDEO CD or CD (Program Play is set to OFF)

- TRACK: Shuffles tracks and plays them in random order.

■ When playing a VIDEO CD, CD, or DVD (Program Play is set to ON)

- ON: Shuffles titles or tracks selected in Program Play and plays them in random order.

To return to normal play

Press CLEAR or select "OFF" in Step 2.

💡 You can set the player to "shuffle" in stop mode as well. After pressing SHUFFLE to select the item you want to set, press \triangleright . Shuffle Play starts.

Note

Up to 200 chapters in a disc can be played in random order when "CHAPTER" is selected.

Playing repeatedly (Repeat Play)

You can play all of the titles or tracks on a disc or a single title, chapter, or track repeatedly. You can use a combination of Shuffle or Program Play modes.

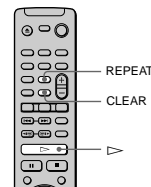

1 Press REPEAT during playback.

The Control Bar appears.

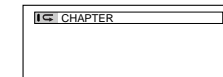

Searching for a Scene

Searching for a Particular Point on a Disc (Scan, Slow-motion Play)

You can locate a particular point on a disc quickly by monitoring the picture or playing back slowly.

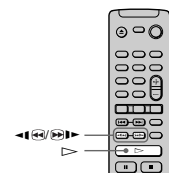

Note

Depending on the DVD/VIDEO CD, you may not be able to do some of the operations described.

Locating a point quickly by playing a disc in fast forward or fast reverse (Scan)

Press \lll or \ggg while playing a disc. When you find the point you want, press \triangleright to return to normal speed. Each time you press the \lll or \ggg button during scan the playback speed changes. Three speeds are available. With each press the indication changes as follows:

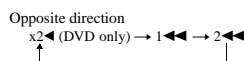
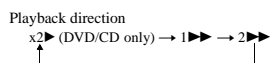

The $x2 \triangleright/x2 \lll$ playback speed is about twice the normal speed. The $2 \triangleright/2 \lll$ playback speed is faster than $1 \triangleright/1 \lll$.

Watching frame by frame (Slow-motion play)

You can use this function only for DVDs or VIDEO CDs. Press \lll or \ggg when the player is in the pause mode. To return to the normal speed, press \triangleright . Each time you press the \lll or \ggg button during Slow-motion play the playback speed changes. Two speeds are available. With each press the indication changes as follows:

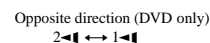
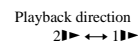

The $2 \triangleright/2 \lll$ playback speed is slower than $1 \triangleright/1 \lll$.

Searching for a Title/Chapter/Track/Index/Scene (Search mode)



You can search a DVD disc by title or chapter, and you can search a VIDEO CD or CD by track, index, or scene.

As titles and tracks are assigned unique numbers on the disc, you can select the desired one by entering its number. Or, you can search for a scene using the time code.

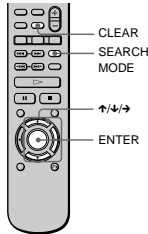

1 Press SEARCH MODE during playback.

The Control Bar appears. “—(**)” appears next to the icon on the Control Bar (** refers to a number). The number in parentheses indicates the total number of titles, tracks, scenes, etc. of the disc.

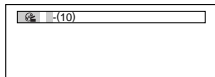

2 Press SEARCH MODE repeatedly to select the search method.

■ When playing a DVD

(TITLE), (CHAPTER), (TIME/TEXT), or (NUMBER INPUT)

Select “TIME/TEXT” to search for a starting point by inputting the time code.

■ When playing a VIDEO CD

(TRACK) or (INDEX)

■ When playing a VIDEO CD with PBC Playback

(SCENE)

■ When playing a CD

(TRACK) or (INDEX)

3 Select the number of the title, track, scene, time code, etc., you want by pressing \uparrow/\downarrow to select the digit, followed by \rightarrow to move the cursor.

For example, to find the scene at 2 hours, 10 minutes, and 20 seconds after the beginning, select “TIME/TEXT” in Step 2 and enter “2:10:20.”

If you make a mistake

Cancel the number by pressing CLEAR, then select another number.

4 Press ENTER.

The player starts playback from the selected number.

If you are playing a disc and it is necessary to enter a number, select “NUMBER INPUT” in Step 2.

Viewing Information About the Disc

Checking the Playing Time and Remaining Time on the Front Panel Display

You can check information about the disc, such as the remaining time, total number of titles of a DVD, or tracks of a CD or VIDEO CD, using the front panel display (page 9).

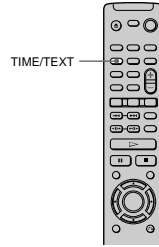

Press TIME/TEXT.

Each time you press TIME/TEXT while playing the disc, the display changes as shown in the following chart.

When playing a DVD

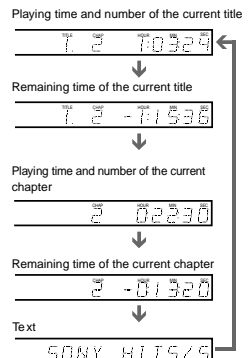

When playing a VIDEO CD (without PBC functions) or

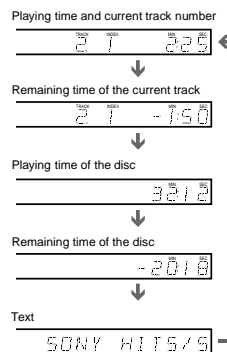

When playing VIDEO CDs with PBC functions, the scene number and the playing time are displayed.

The playing time and remaining time of the current chapter, title, track, scene, or disc will also appear on your TV screen. See the following section “Checking the Playing Time and Remaining Time” for instructions on how to read this information.

Note

Depending on the type of disc being played and the playing mode, the above mentioned disc information may not be displayed.

Checking the Playing Time and Remaining Time

You can check the playing time and remaining time of the current title, chapter, or track, and the total playing time or remaining time of the disc. Also, you can check the DVD/CD text recorded on the disc.



1 Press DISPLAY once during playback.

The Status Bar is displayed.

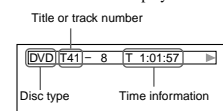

2 Press TIME/TEXT repeatedly to change the time information.

The display and the kinds of time that you can change depend on the disc you are playing.

■ When playing a DVD

- T *:*:*:* Playing time of the current title
- T-*:*:*:* Remaining time of the current title
- C *:*:*:* Playing time of the current chapter
- C-*:*:*:* Remaining time of the current chapter

■ When playing a VIDEO CD (with PBC functions)

- *:*:*:* Playing time of the current scene

■ When playing a VIDEO CD (without PBC functions) or CD

- T *:*:*:* Playing time of the current track
- T-*:*:*:* Remaining time of the current track
- D *:*:*:* Playing time of the current disc
- D-*:*:*:* Remaining time of the current disc

To turn off the Status Bar

Press DISPLAY repeatedly until the Status Bar is turned off.

Checking the DVD/CD text

Press TIME/TEXT repeatedly in Step 2 to display the text recorded on the DVD/CD.

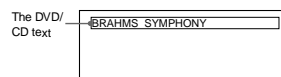

If the DVD/CD text does not fit on a single line, you can see the entire text by watching it scroll across the front panel display.

You can select the time and text directly by pressing TIME/TEXT.

Notes

- Only letters of the alphabet can be displayed.
- This player can only display the first level of DVD/CD text, such as the disc's name or title.

Changing the Sound



If the DVD is recorded with multilingual tracks, you can select the language you want while playing the DVD.

If the DVD is recorded in multiple audio formats (PCM, Dolby Digital or DTS), you can select the audio format you want while playing the DVD.

With stereo CDs or VIDEO CDs, you can select the sound from the right or left channel and listen to the sound of the selected channel through both the right and left speakers. (In this case, the sound loses its stereo effect.) For example, when playing a disc containing a song with the vocals on the right channel and the instruments on the left channel, you can select the left channel and hear the instruments from both speakers.

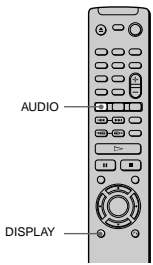

1 Press AUDIO during playback.

The Control Bar is displayed. The number in parentheses indicates the total number of available audio signals.

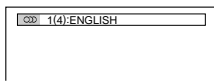

2 Press AUDIO repeatedly to select the desired audio signal

■ When playing a DVD

Depending on the DVD, the choice of language varies.

When 4 digits are displayed, they represent the language code. Refer to the language code list on page 67 to see which language the code represents. When the same language is displayed two or more times, the DVD is recorded in multiple audio formats.

■ When playing a VIDEO CD or CD

The default setting is underlined.

- STEREO: The standard stereo sound
- 1/L: The sound of the left channel (monaural)
- 2/R: The sound of the right channel (monaural)

Notes

- For discs not in multiple audio format, you cannot change the sound.
- While playing a DVD, the sound may change automatically.

Checking the audio signal format



If you press DISPLAY twice during playback, the format of the current audio signal (Dolby Digital, DTS, PCM, etc.) appears as shown below.

Example

- Dolby Digital 5.1 ch

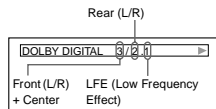

TVS (TV Virtual Surround) STANDARD

Uses sound imaging to create virtual rear speakers from the sound of the front speakers (L/R) without using actual rear speakers. The virtual speakers are reproduced as shown in the illustration below. Use this setting when you want to use TVS with 2 separate speakers and retain the sound quality.

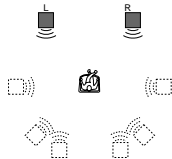

- L: Left front speaker
- R: Right front speaker
- : Virtual speakers

You can also change the TVS setting by pressing SURROUND on the player. If you select any TVS setting other than "OFF," the indicator on the player lights up.

Notes

- When you select an effect, the sound cuts off for a moment.
- When the playing signal does not contain a signal for the rear speakers (page 43), the surround effects may be difficult to hear.
- When you select one of the TV modes, turn off the surround setting of connected TV or amplifier (receiver).
- Make sure that your listening position is between and at an equal distance from your speakers, and that the speakers are located in similar surroundings. Otherwise, the TVS effect may be hard to discern.
- TVS NIGHT only works with Dolby Digital discs. However, not all discs will respond to the TVS NIGHT function in the same way.
- If you use the DIGITAL OUT (COAXIAL and OPTICAL) jacks and set "DOLBY DIGITAL" to "DOLBY DIGITAL" in "AUDIO SETUP," sound will come from your speakers but it will not have the TVS effect.

To reset the TVS setting

In Step 2, select "OFF."

TVS (TV Virtual Surround) DYNAMIC

Uses sound imaging to create virtual rear speakers from the sound of the front speakers (L/R) without using actual rear speakers (shown below). The sound imaging effect is distinct and clearly reproduces each aural element of the audio track.

This mode is effective when the distance between the front L and R speakers is short, such as with built-in speakers on a stereo TV.

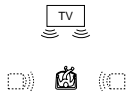

TVS (TV Virtual Surround) WIDE

Uses sound imaging to create virtual rear speakers from the sound of the front speakers (L/R) without using actual rear speakers. The virtual speakers are reproduced as shown in the illustration below. This gives the sound an expanded effect that fills the area surrounding the listener.

This mode is effective when the distance between the front L and R speakers is short, such as with built-in speakers on a stereo TV.

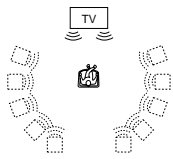

TVS (TV Virtual Surround) NIGHT

The large sounds, such as explosions, are suppressed, but the quieter sounds are unaffected. This feature is useful when you don't want to disturb other people but still want to hear the dialog and enjoy the surround sound effects of TVS WIDE.

• Dolby Digital 3 ch

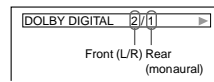

• PCM (Stereo)

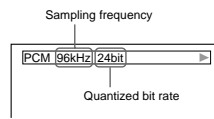

About audio signals

Audio signals recorded in a disc contain the sound elements (channels) shown below. Each channel is output from a separate speaker.

- Front (L)
- Front (R)
- Center
- Rear (L)
- Rear (R)
- Rear (Monaural): This signal can be either the Dolby Surround Sound processed signals or the Dolby Digital sound's monaural rear audio signals.
- LFE (Low Frequency Effect) signal

Note

If "DTS" is set to "OFF" in "AUDIO SETUP," the DTS track selection option will not appear on the screen even if the disc contains DTS tracks (page 59).

TV Virtual Surround Sound Settings (rvs)



When you connect a stereo TV or 2 front speakers, TV Virtual Surround lets you enjoy surround sound effects by using sound imaging to create virtual rear speakers from the sound of the front speakers (L: left, R: right) without using actual rear speakers. This function is designed to work with the LINE OUT L/R (AUDIO) 1/2 jacks.

Note that if you select one of the TVS settings while playing a DVD, the player does not output Dolby Digital signals from the DIGITAL OUT (COAXIAL and OPTICAL) jacks (when you set "DOLBY DIGITAL" in "AUDIO SETUP" to "D-PCM") (page 59).

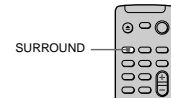

1 Press SURROUND during playback.

The Control Bar is displayed.

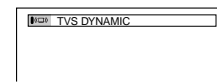

2 Press SURROUND repeatedly to select one of the TVS (TV Virtual Surround) sounds

Refer to the explanations given for each item.

- TVS DYNAMIC
- TVS WIDE
- TVS NIGHT
- TVS STANDARD

Enjoying Movies

Changing the Angles

If various angles (multi-angles) for a scene are recorded on the DVD, "ANGLE" appears in the front panel display. This means that you can change the viewing angle.

For example, while playing a scene of a train in motion, you can display the view from either the front of the train, the left window of the train, or from the right window without having the train's movement interrupted.

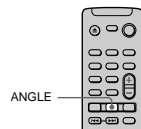

1 Press ANGLE during playback.

The Control Bar is displayed. The number in parentheses indicates the total number of available angles.

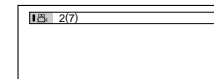

2 Press ANGLE repeatedly to select the angle number.

The scene changes to the selected angle.

Note

Depending on the DVD, you may not be able to change the angles even if multi-angles are recorded on the DVD.

Displaying the Subtitles



If subtitles are recorded on the disc, you can turn the subtitles on and off whenever you want while playing. If multilingual subtitles are recorded on the disc, you can change the subtitle language while playing, and turn it on or off whenever you want. For example, you can select the language you want to practice and turn the subtitles on for better understanding.

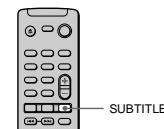

1 Press SUBTITLE during playback.

The Control Bar is displayed. The number in parentheses indicates the total number of available subtitles.

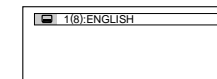

2 Press SUBTITLE repeatedly to select the language.

Depending on the DVD, the choice of language varies.

When 4 digits are displayed, they indicate the language code. Refer to the language code list on page 67 to see which language the code represents.

To turn off the subtitles

Select "OFF" in Step 2.

Note

Depending on the DVD, you may not be able to change the subtitles even if multilingual subtitles are recorded on it.

Adjusting the Picture Quality (BNR)

The Block Noise Reduction (BNR) function adjusts the picture quality by reducing the "block noise" or mosaic like patterns that appear on your TV screen.

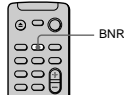

1 Press BNR during playback.

The Control Bar is displayed.



2 Press BNR repeatedly to select a level.

As the value increases, the mosaic like patterns on your TV screen will decrease.

- 1: reduces the "block noise."
- 2: reduces the "block noise" more than 1.
- 3: reduces the "block noise" more than 2.

To reset the BNR setting

Select "OFF" in Step 2.

 You can also change the BNR value by pressing BNR on the player. If you select any setting other than "OFF," the indicator on the player lights up.

Notes

- If the outlines of the images on your screen should become blurred, set BNR to "OFF."
- Depending on the disc or the scene being played, the BNR effect may be hard to discern.

5 Enter or re-enter your 4-digit password by pressing \uparrow/\downarrow to select the digit, followed by \rightarrow to move the cursor. Then press ENTER.

"Custom parental control is set." appears and then the screen returns to the Control Menu display.

If you make a mistake entering your password

Press \leftarrow before you press ENTER and input the correct number.

If you make a mistake

Press \rightarrow RETURN and repeat from Step 3.

To turn off the Control Menu

Press \rightarrow RETURN and then DISPLAY repeatedly until the Control Menu is turned off.

To turn off the Custom Parental Control function

- 1 In Step 4, select "OFF \rightarrow ," then press ENTER.
- 2 Enter your 4-digit password using \uparrow/\downarrow to select the digit, followed by \rightarrow to move the cursor. Then press ENTER.

To change the password

- 1 In Step 4, press \uparrow/\downarrow to select "PASSWORD \rightarrow ," then press ENTER. The display for entering the password appears.
- 2 Enter your 4-digit password using \uparrow/\downarrow to select the digit, followed by \rightarrow to move the cursor. Then press ENTER.
- 3 Enter a new 4-digit password using \uparrow/\downarrow to select the digit, followed by \rightarrow to move the cursor. Then press ENTER.
- 4 To confirm your password, re-enter it using \uparrow/\downarrow to select the digit, followed by \rightarrow to move the cursor. Then press ENTER.

Playing the disc for which Custom Parental Control is set

1 Insert the disc for which Custom Parental Control is set.

The CUSTOM PARENTAL CONTROL display appears.

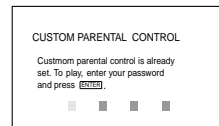

2 Enter your 4-digit password using \uparrow/\downarrow to select the digit, followed by \rightarrow to move the cursor. Then press ENTER.

The player is ready for playback.

 If you forget your password, enter the 6-digit number "199703" when the CUSTOM PARENTAL CONTROL display asks you for your password, then press ENTER. (Press \rightarrow after the 4th digit to allow the entire 6-digit number to be entered.) The display will ask you to enter a new 4-digit password.

Limiting playback by children (Parental Control)

Playback of some DVDs can be limited according to a predetermined level such as the age of the users. The Parental Control function allows you to set a playback limitation level.

A scene that is limited is not played, or it is replaced by a different scene.

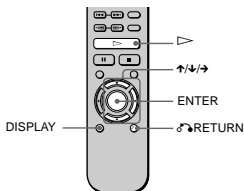

Using Various Additional Functions

Locking Discs (Custom Parental Control, Parental Control)

You can set two kinds of playback restrictions for the desired disc.

- Custom Parental Control
 - Parental Control
- You can set the playback restrictions so that the player will not play inappropriate discs. Playback of some DVDs can be limited according to a predetermined level such as the age of the users. The same password is used for both Parental Control and Custom Parental Control.

Custom Parental Control

You can set the same Custom Parental Control password for up to 50 discs. When you set the fifty-first-disc, the first disc is cancelled.

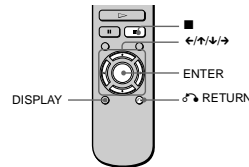

1 Insert the disc you want to lock.

If the disc is playing, press \blacksquare to stop playback.

2 Press DISPLAY while the player is in stop mode.

The Control Menu is displayed.

3 Press \uparrow/\downarrow to select (CUSTOM PARENTAL CONTROL), then press ENTER.

"CUSTOM PARENTAL CONTROL" is selected.

1 Press DISPLAY while the player is in stop mode.

The Control Menu is displayed.

2 Press \uparrow/\downarrow to select (SETUP), then press ENTER.

3 Press \uparrow/\downarrow to select "CUSTOM," then press ENTER.

The Setup Display appears.

4 Press \uparrow/\downarrow to select "CUSTOM SETUP," then press ENTER.

"CUSTOM SETUP" is displayed.

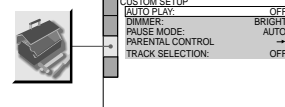

5 Press \uparrow/\downarrow to select "PARENTAL CONTROL," then press ENTER.

If you have not entered a password

The display for registering a new password appears.

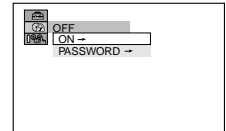
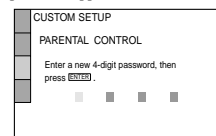

4 Press \uparrow/\downarrow to select "ON \rightarrow ," then press ENTER.

If you have not entered a password

The display for registering a new password appears.

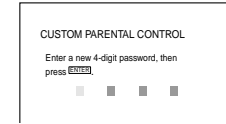

Enter a 4-digit password by pressing \uparrow/\downarrow to select the digit, followed by \rightarrow to move the cursor. Then press ENTER. The display for confirming the password appears.

When you have already registered a password

The display for entering the password appears.

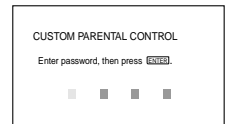

continued

Using Various Additional Functions

47

Enter a 4-digit password using by pressing \uparrow/\downarrow to select the digit, followed by \rightarrow to move the cursor. Then press ENTER. The display for confirming the password appears.

When you have already registered a password

The display for entering the password appears.

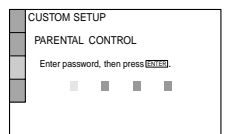

6 Enter or re-enter your password using \uparrow/\downarrow to select the digit, followed by \rightarrow to move the cursor. Then press ENTER.

The display for setting the playback limitation level and changing the password appears.

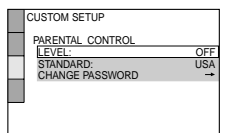

7 Press \uparrow/\downarrow to select "STANDARD," then press ENTER.

The selection items for "STANDARD" are displayed.

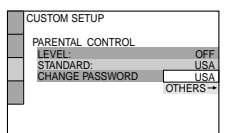

continued

Using Various Additional Functions

49

8 Press \uparrow/\downarrow to select a geographic area as the playback limitation level, then press ENTER.

The area is selected. When you select "OTHERS \rightarrow ," select and enter the standard code in the table on page 51 using \uparrow/\downarrow .

9 Press ENTER.
The selection items for "LEVEL" are displayed.

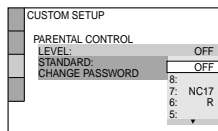

10 Select the level you want using \uparrow/\downarrow , then press ENTER.

Parental Control setting is complete.

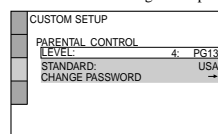

The lower the value, the more strict the limitation.

If you make a mistake

Press \rightarrow RETURN to go back to the previous screen.

To turn off the Control Menu

Press DISPLAY repeatedly until the Control Menu is turned off.

To turn off the Parental Control function and play the DVD after entering your password

Set, "LEVEL" to "OFF" in Step 10.

To change the password

1 In Step 7, select "CHANGE PASSWORD \rightarrow " using \downarrow , then press ENTER.
The display for entering the password appears.

2 Follow Step 6 to enter a new password.

Playing the disc for which Parental Control is set

1 Insert the disc and press \triangleright .
The Control Bar appears.

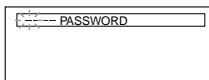

2 Enter your 4-digit password using \uparrow/\downarrow to select the digit, followed by \rightarrow to move the cursor. Then press ENTER.
The player starts playback.

Note
If you forget your password, remove the disc and repeat Step 1 to 5 of "Limiting playback by children." When you are asked to enter your password, enter "199703," then press ENTER. (Press \rightarrow after the 4th digit to allow the entire 6 digit number to be entered.) The display will ask you to enter a new 4-digit password. After you enter a new 4-digit password in Step 6, replace the disc in the player and press \triangleright . When the Control Bar appears, enter your new password.

Note

When you play DVDs which do not have the Parental Control function, playback cannot be limited on this player.

Area Code

Standard	Code number	Standard	Code number
Argentina	2044	Korea	2304
Australia	2047	Malaysia	2363
Austria	2046	Mexico	2362
Belgium	2057	Netherlands	2376
Brazil	2070	New Zealand	2390
Canada	2079	Norway	2379
Chile	2090	Pakistan	2427
China	2092	Philippines	2424
Denmark	2115	Portugal	2436
Finland	2165	Russia	2489
France	2174	Singapore	2501
Germany	2109	Spain	2149
Hong Kong	2219	Sweden	2499
India	2248	Switzerland	2086
Indonesia	2238	Taiwan	2543
Italy	2254	Thailand	2528
Japan	2276	United Kingdom	2184

Operation Sound Effects (Sound Feedback)

The player beeps when the following operations are performed. The default setting of the Sound Feedback function is set to off.

Operation	Operation sound
Power is turned on	One beep
Power is turned off	Two beeps
\triangleright is pressed	One beep
II is pressed	Two beeps
Playback is stopped	One long beep
Operation is not possible	Three beeps

To set Sound Feedback

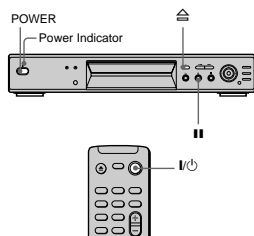

1 Press POWER on the player, then press I/O on the remote.

The power indicator lights up in green. When there is a disc in the player, press II and remove the disc. Then press II again to close the disc tray.

2 Press and hold II on the player for more than two seconds.

You will hear one beep and the Sound Feedback function is turned on.

To turn off the Sound Feedback function

When there is no disc in the player, press and hold II on the player for more than two seconds. You will hear two beeps and the Sound Feedback function is turned off.

Controlling Your TV with the Supplied Remote

By adjusting the remote signal, you can control your TV with the supplied remote.

Controlling TVs with the remote

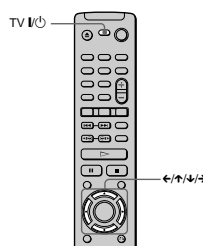

1 Hold down TV I/O, and enter your TV's manufacturer's code (see the table below) using $\leftarrow/\uparrow/\downarrow/\rightarrow$.

2 Release TV I/O.

Manufacturer's codes of controllable TVs.

Manufacture	Press $\leftarrow/\uparrow/\downarrow/\rightarrow$ to input code
Sony (default)	$\uparrow\uparrow$
General Electric	$\uparrow\leftarrow$
JVC	$\downarrow\uparrow$
Panasonic	$\rightarrow\rightarrow$
Philips	$\uparrow\rightarrow$
Quasar	$\rightarrow\downarrow$
RCA	$\uparrow\leftarrow$
Samsung	$\downarrow\downarrow$
Sanyo	$\uparrow\downarrow$
Sears	$\rightarrow\leftarrow$ or $\uparrow\leftarrow$
Sharp	$\rightarrow\downarrow$
Toshiba	$\rightarrow\leftarrow$
Zenith	$\rightarrow\uparrow$

Notes

- If you enter a new manufacturer's code, the code previously entered will be erased.
- When you replace the batteries of the remote, the code you have set may be reset to the default setting. Set the appropriate code again.

Controlling the TV

By adjusting remote signal, you can control the sound level, input source, and power switch of your TV with the supplied remote.

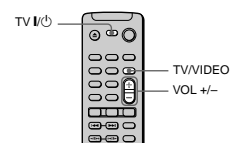

You can control your TV using the buttons below.

By pressing	You can
TV I/O	Turn the TV on or off
VOL (volume) +/-	Adjust the volume of the TV
TV/VIDEO	Switch the TV's input source between the TV and other input source

Note

Depending on the units being connected, you may not be able to control your TV or to use some of the buttons.

Using the Setup Display



By using the Setup Display, you can make various adjustments to items such as picture and sound. You can also set a language for the subtitles and the Setup Display, among other things. If you press SETUP on the remote, you can directly display the settings in "SETUP" on your screen. For details on each Setup Display item, see page 55. For an overall list of Setup Display items, see page 68.

How to use the Setup Display

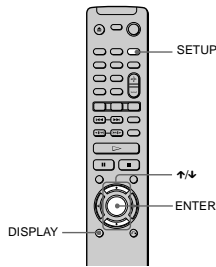

1 Press DISPLAY on the remote when the player is in stop mode.
The Control Menu appears

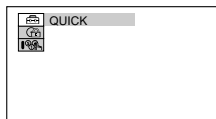

2 Press \uparrow/\downarrow to select (SETUP) and press ENTER.

3 Press \uparrow/\downarrow to select "CUSTOM" and press ENTER.
The Setup Display appears.

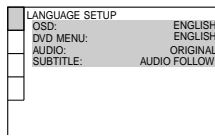

4 Press \uparrow/\downarrow to select the setup item from the displayed list: "LANGUAGE SETUP," "SCREEN SETUP," "CUSTOM SETUP," or "AUDIO SETUP." Then press ENTER.
Example: SCREEN SETUP

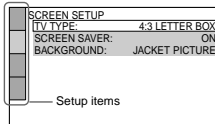

5 Select an item using \uparrow/\downarrow , then press ENTER.
The options for the selected item appear.
Example: TV TYPE

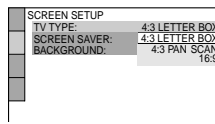

6 Select a setting using \uparrow/\downarrow , then press ENTER.
The setting is selected and setup is complete.
Example: 16:9

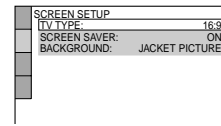

To turn off the Setup Display

Press DISPLAY repeatedly until the Setup Display is turned off.

If you select "QUICK" in Step 3, you will enter Quick Setup mode (page 24). Follow from Step 5 of the Quick Setup explanation to make basic adjustments.

If you select "RESET" in Step 3, you can reset all of the "SETUP" settings on page 68 (except for "PARENTAL CONTROL") to the default settings. After you select "RESET" and press ENTER, select "YES" and press ENTER to reset the settings (it takes a few seconds to complete), or select "NO" and press ENTER to return to the Control Menu. Do not press POWER or \mathbb{P} when resetting the player.

Setting the Display or Sound Track Language

(LANGUAGE SETUP)



"LANGUAGE SETUP" allows you to set various languages for the on-screen display or sound track.

Select "LANGUAGE SETUP" in the Setup Display. For details on using the display, see "Using the Setup Display" (page 54).

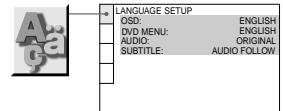

■ OSD (On-Screen Display)

Switches the display language on the screen. Selects the language from the displayed list.

■ DVD MENU (DVD only)

You can select the desired language for the DVD menu.

■ AUDIO (DVD only)

Switches the language of the sound track. Selects the language from the displayed list. When you select "ORIGINAL," the language given priority in the disc is selected.

■ SUBTITLE (DVD only)

Switches the language of the subtitles recorded on the DVD. Select the language from the displayed list. When you select "AUDIO FOLLOW," the language for the subtitles changes according to the language you selected for the sound track.

If you select "OTHERS \rightarrow " in "DVD MENU," "SUBTITLE," and "AUDIO," select and enter the language code from the list using \uparrow/\downarrow to select the digit, followed by \rightarrow to move the cursor (page 67). After you have made a selection, the language code (4 digits) is displayed the next time you select "OTHERS \rightarrow ."

Note

When you select a language that is not recorded on the DVD, one of the recorded languages will be automatically selected (except for the "OSD").

Settings for the Display

(SCREEN SETUP)

Choose settings according to the TV to be connected.

Select "SCREEN SETUP" in the Setup Display. For details on using the display, see "Using the Setup Display" (page 54). The default settings are underlined.

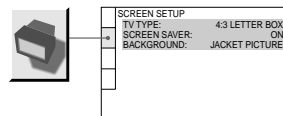

■ TV TYPE (DVD only)

Selects the aspect ratio of the connected TV (4:3 standard or wide).

<u>4:3 LETTER BOX</u>	Select this when you connect a 4:3 screen TV. Displays a wide picture with bands on the upper and lower portions of the screen.
4:3 PAN SCAN	Select this when you connect a 4:3 screen TV. Automatically displays the wide picture on the entire screen and cuts off the portions that do not fit.
16:9	Select this when you connect a wide-screen TV or a TV with a wide mode function.

4:3 LETTER BOX



4:3 PAN SCAN



16:9



Note

Depending on the DVD, "4:3 LETTER BOX" may be selected automatically instead of "4:3 PAN SCAN" or vice versa.

■ SCREEN SAVER

Turns on and off the screen saver so that the screen saver image appears when you leave the player in pause or stop mode for 15 minutes, or when you play back a CD for more than 15 minutes. The screen saver will help prevent your display device from becoming damaged (ghosting). Press \triangleright to turn off the screen saver.

ON	Turns on the screen saver.
OFF	Turns off the screen saver.

■ BACKGROUND

Selects the background color or picture on the TV screen in stop mode or while playing a CD.

JACKET PICTURE	The jacket picture (still picture) appears in the background, but only when the jacket picture is already recorded on the disc (CD-EXTRA etc.). If the disc does not contain a jacket picture, the "GRAPHICS" picture appears.
GRAPHICS	A preset picture stored in the player appears in the background.
BLUE	The background color is blue.
BLACK	The background color is black.

Custom Settings (CUSTOM SETUP)



Allows setting up Parental Control and other settings.

Select "CUSTOM SETUP" in the Setup Display. For details on using the display, see "Using the Setup Display" (page 54). The default settings are underlined.

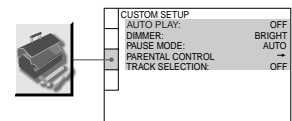

■ AUTO PLAY

Selects the Auto Play setting when you turn on the player.

<u>OFF</u>	Does not use "TIMER," "DEMO1," or "DEMO2" to start playback.
TIMER	Starts playing when the player is turned on. The player can be played at any time when connected to a timer (not supplied). Set the timer when the player is in standby mode (the power indicator lights up in red).
DEMO1	Starts playing the first demonstration automatically.
DEMO2	Starts playing the second demonstration automatically.

■ DIMMER

Adjusts the lighting of the front panel display.

<u>BRIGHT</u>	Makes the front panel display bright.
DARK	Makes the front panel display dark.
OFF	Turns off the lighting of the front panel display.

■ PAUSE MODE (DVD only)

Selects the picture in pause mode.

AUTO	The picture, including subjects that move dynamically, is output with no jitter. Normally select this position.
FRAME	The picture, including subjects that do not move dynamically, is output in high resolution.

■ PARENTAL CONTROL → (DVD only)

Sets a password and playback limitation level for DVDs with playback limitation for children. For details, see "Limiting playback by children (Parental Control)" (page 47).

■ TRACK SELECTION (DVD only)

Gives the sound track which contains the highest number of channels priority when you play a DVD on which multiple audio formats (PCM, DTS or Dolby Digital format) are recorded.

OFF	No priority given.
AUTO	Priority given.

Notes

- When you set the item to "AUTO," the language may change. The "TRACK SELECTION" setting has higher priority than the "AUDIO" settings in "LANGUAGE SETUP" (page 55).
- If you set "DTS" to "OFF" (page 59) set the DTS sound track is not played even if you set "TRACK SELECTION" to "AUTO."
- If PCM, DTS and Dolby Digital sound tracks have the same number of channels, the player selects PCM, DTS and Dolby Digital sound tracks in this order.
- Depending on the DVD, the audio channel with priority may be predetermined. In this case, you cannot give priority to the DTS, or Dolby Digital, format by selecting "AUTO."

Settings for the Sound (AUDIO SETUP)

"AUDIO SETUP" allows you to set the sound according to the playback and connection conditions.

Select "AUDIO SETUP" in the Setup Display. For details on using the display, see "Using the Setup Display" (page 54). The default settings are underlined.

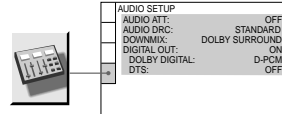

■ AUDIO ATT (attenuation)

If the playback sound is distorted, set this item to "ON." The player reduces the audio output level. This function affects the output of the following jacks:

- LINE OUT L/R (AUDIO) 1/2 jacks

OFF	Turns off the audio attenuation. Normally, select this position.
ON	Reduces the audio output level so that no sound distortion occurs. Select this when the playback sound from the speakers is distorted.

■ AUDIO DRC (Dynamic Range Control) (DVD only)

Makes the sound clear when the volume is turned down when playing a DVD that has the AUDIO DRC function. This affects the output from the following jacks:

- LINE OUT L/R (AUDIO) 1/2 jacks
- DIGITAL OUT (OPTICAL and COAXIAL) jacks only when "DOLBY DIGITAL" is set to "D-PCM" in "DIGITAL OUT." (page 59)

Note

If you select one of the TV's settings while playing a DVD, the player does not output Dolby Digital signals from the DIGITAL OUT (COAXIAL and OPTICAL) jacks (when you set "DOLBY DIGITAL" in "AUDIO SETUP" to "D-PCM").

D-PCM	Select this when the player is connected to an audio component lacking a built-in Dolby Digital decoder. You can select whether the signals conform to Dolby Surround (Pro Logic) or not by making adjustments to the "DOWNMIX" item in "AUDIO SETUP" (page 58).
DOLBY DIGITAL	Select this when the player is connected to an audio component with a built-in Dolby Digital decoder. If the player is connected to an audio component lacking a built-in Dolby Digital decoder, do not set this. Otherwise, when you play the Dolby Digital sound track, a loud noise (or no sound) will come out from the speakers, affecting your ears or causing the speakers to be damaged.

DTS

Selects if DTS signals are output via the DIGITAL OUT (OPTICAL and COAXIAL) jacks.

OFF	Select this when the player is connected to an audio component lacking a built-in DTS decoder. Note, however, that the DTS signals contained in a CD are output even if "OFF" is selected.
ON	Select this when the player is connected to an audio component having a built-in DTS decoder. If the player is connected to an audio component lacking a built-in DTS decoder, do not set this. Otherwise, when you play the DTS sound track, a loud noise (or no sound) will come out from the speakers, affecting your ears or causing the speakers to be damaged.

STANDARD	Normally, select this position
TV MODE	Makes the low sounds clear even if you turn the volume down. It is especially recommended when you listen to the sound using the speakers of the TV.
WIDE RANGE	Gives you the feeling of being at a live performance. When you use high quality speakers, it is even more effective.

■ DOWNMIX (DVD only)

Switches the mixing down methods when you play a DVD on which rear signal components such as LS, RS, or S are recorded in Dolby Digital format. For details on the rear signal components, see "Changing the Sound" (page 42). This function affects the output of the following jacks:

- LINE OUT L/R (AUDIO) 1/2 jacks
- DIGITAL OUT (OPTICAL and COAXIAL) jacks when "DOLBY DIGITAL" is set to "D-PCM" in "DIGITAL OUT" (page 59).

DOLBY SURROUND	Select this when the player is connected to an audio component that conforms to Dolby Surround (Pro Logic). The output signals which reproduce the Dolby Surround effect are downmixed to 2 channels.
NORMAL	Select this when the player is connected to an audio component that does not conform to Dolby Surround (Pro Logic). All of the output signals are downmixed to 2 channels without the Dolby Surround (Pro Logic) effect.

■ DIGITAL OUT

Selects if audio signals are output via the DIGITAL OUT (OPTICAL and COAXIAL) jacks.

ON	Normally, select this position. When you select "ON," set "DOLBY DIGITAL," and "DTS." For details on setting these items, see "Setting the digital output signal."
OFF	The player does not output the audio signals via the DIGITAL OUT (OPTICAL and COAXIAL) jacks. The influence of the digital circuit upon the analog circuit is minimal.

Setting the digital output signal

Switches the method of outputting audio signals when you connect the following component using a digital cord via the DIGITAL OUT (OPTICAL or COAXIAL) jacks.

- Amplifier (receiver) with digital input jack
- Amplifier (receiver) with a built-in DTS, or DOLBY DIGITAL decoder
- MD or DAT deck

For connection details, see page 19. Select "DOLBY DIGITAL," and "DTS" after setting "DIGITAL OUT" to "ON."

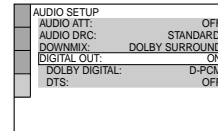

■ DOLBY DIGITAL

Selects the Dolby Digital signals output via the DIGITAL OUT (OPTICAL and COAXIAL) jacks.

Additional Information

Troubleshooting

If you experience any of the following difficulties while using the CD/DVD player, use this troubleshooting guide to help remedy the problem before requesting repairs. Should any problem persist, consult your nearest Sony dealer.

Power

The power is not turned on.

- ➔ Check that the AC power cord is connected securely.

Picture

There is no picture.

- ➔ The connecting cords are not connected securely.
- ➔ The connecting cords are damaged.
- ➔ The CD/DVD player is not connected to the correct TV input jack (page 17).
- ➔ The video input on the TV is not set so that you can view pictures from the CD/DVD player.

Picture noise appears.

- ➔ The disc is dirty or flawed.
- ➔ If the picture output from your CD/DVD player goes through your VCR to get to your TV, the copy-protection signal applied to some DVD programs could affect picture quality. If you still experience problems even when you connect your CD/DVD player directly to your TV, please try connecting your CD/DVD player to your TV's S video input (page 17).

Even though you set the aspect ratio in "TV TYPE" of "SCREEN SETUP," the picture does not fill the screen.

- ➔ The aspect ratio of the disc is fixed on your DVD.

Sound

There is no sound.

- ➔ The connecting cord is not connected securely.
- ➔ The connecting cord is damaged.
- ➔ The CD/DVD player is connected to the wrong input connector on the amplifier (receiver) (21, 22, 23).
- ➔ The amplifier (receiver) input was not changed so that you can listen to the CD/DVD player.
- ➔ The CD/DVD player is in pause mode or in Slow-motion play mode.
- ➔ The CD/DVD player is in fast forward or fast reverse mode.
- ➔ If the audio signal does not come through the DIGITAL OUT (OPTICAL and COAXIAL) jacks, check the audio settings (page 58).

Sound is noisy.

- ➔ The disc is dirty or flawed.
- ➔ When playing a CD with DTS sound tracks, noise will come from the LINE OUT L/R (AUDIO) 1/2 jacks (page 29).

Sound distortion occurs

- ➔ Set "AUDIO ATT" in "AUDIO SETUP" to "ON" (page 58).

Operation

The remote does not function.

- ➔ There are obstacles between the remote and the CD/DVD player.
- ➔ The distance between the remote and the CD/DVD player is too far.
- ➔ The remote is not pointed at the remote sensor on the CD/DVD player.
- ➔ The batteries in the remote are weak.

The disc does not play.

- There is no disc inside.
- The disc is turned over.
Insert the disc with the playback side facing down on the disc tray.
- The disc is skewed.
- The CD/DVD player cannot play CD-ROMs, etc. (page 6).
- The region code on the DVD does not match the CD/DVD player.
- Moisture has condensed inside the CD/DVD player. Remove the disc and leave the CD/DVD player turned on for about half an hour. Turn on the power again before playing the disc (page 3).

The disc does not start playing from the beginning.

- Program Play, Shuffle Play, Repeat Play, or A-B Repeat Play has been selected (page 33). Press CLEAR to cancel these functions before playing a disc.
Resume Play has been selected.
During stop, press ■ on the CD/DVD player or the remote and then start playback (page 30).
- The title, DVD or PBC menu automatically appears on the TV screen.

The player starts playing the disc automatically.

- The DVD features an auto playback function.
- "AUTO PLAY" in "CUSTOM SETUP" is set to "TIMER" (page 57).

Playback stops automatically.

- Some discs may contain an auto pause signal. While playing such a disc, the CD/DVD player stops playback at the auto pause signal.

You cannot perform some functions such as stop, Scan, Slow-motion play, Repeat Play, Shuffle Play, or Program Play.

- Depending on the disc, you may not be able to do some of the operations above. See the operating manual that comes with the disc.

Messages do not appear on the screen in the language you want.

- In the Setup Display, select the desired language for the on-screen display in "OSD" under "LANGUAGE SETUP" (page 55).

The language for the sound track cannot be changed.

- Multilingual tracks are not recorded on the DVD being played.
- The DVD prohibits the changing of the language for the sound track.

The subtitle language cannot be changed.

- Multilingual subtitles are not recorded on the DVD being played.
- The DVD prohibits the changing of the subtitles.

The subtitle cannot be turned off.

- The DVD prohibits the subtitles being turned off.

The angles cannot be changed.

- Multi-angles are not recorded on the DVD being played. The angle can be changed when the "ANGLE" indicator lights up on the front panel display (page 9).
- The DVD prohibits changing of the angles.

The CD/DVD player does not operate properly.

- When static electricity, etc., causes the CD/DVD player to operate abnormally, press POWER on the player to turn the CD/DVD player off and then on again.

Nothing is displayed on the front panel display.

- "DIMMER" in "CUSTOM SETUP" is set to "OFF." Set "DIMMER" to "BRIGHT" or "DARK" (page 57).

5 numbers or letters are displayed on the screen and on the front panel display.

- The self-diagnosis function was activated. (See the table on page 63.)

The disc tray does not open and "LOCKED" appears on the front panel display.

- Contact your Sony dealer or local authorized Sony service facility.

Self-diagnosis Function

(When letters/numbers appear in the display)

When the self-diagnosis function is activated to prevent the player from malfunctioning, a five-character service number (e.g., C 13 00) with a combination of a letter and digits appears on the screen and the front panel display. In this case, check the following table.



First three characters of the service number	Cause and/or corrective action
C 13	The disc is dirty. → Clean the disc with a soft cloth (page 7).
C 31	The disc is not inserted correctly. → Re-insert the disc correctly.
E XX (xx is a number)	To prevent a malfunction, the player has performed the self-diagnosis function. → Contact your nearest Sony dealer or local authorized Sony service facility and give the 5-character service number. Example: E 61 10

Glossary

Chapter (page 9)

Sections of a picture or a music feature that are smaller than titles. A title is composed of several chapters. Depending on the disc, no chapters may be recorded.

Dolby Digital (page 23, 59)

Digital audio compression technology developed by Dolby Laboratories. This technology conforms to 5.1-channel surround sound. The rear channel is stereo and there is a discrete subwoofer channel in this format. Dolby Digital provides the same 5.1 discrete channels of high quality digital audio found in Dolby Digital cinema audio systems. Good channel separation is realized because all of the channel data is recorded discretely and little deterioration is realized because all channel data processing is digital.

Dolby Surround (Pro Logic) (page 22)

Audio signal processing technology that Dolby Laboratories developed for surround sound. When the input signal contains a surround component, the Pro Logic process outputs the front, center and rear signals. The rear channel is monaural.

DTS (page 23, 60)

Digital audio compression technology that Digital Theater Systems, Inc. developed. This technology conforms to 5.1-channel surround sound. The rear channel is stereo and there is a discrete subwoofer channel in this format. DTS provides the same 5.1 discrete channels of high quality digital audio. Good channel separation is realized because all of the channel data is recorded discretely and little deterioration is realized because all channel data processing is digital.

DVD (page 6)

A disc that contains up to 8 hours of moving pictures even though its diameter is the same as a CD.

The data capacity of a single-layer and single-sided DVD is 4.7 GB (Giga Byte), which is 7 times that of a CD. The data capacity of a double-layer and single-sided DVD is 8.5 GB, a single-layer and double-sided DVD is 9.4 GB, and double-layer and double-sided DVD is 17 GB.

The picture data uses the MPEG 2 format, one of the worldwide standards of digital compression technology. The picture data is compressed to about 1/40 (average) of its original size. The DVD also uses a variable rate coding technology that changes the data to be allocated according to the status of the picture. Audio information is recorded in Dolby Digital as well as in PCM, allowing you to enjoy a more real audio presence. Furthermore, various advanced functions such as the multi-angle, multilingual, and Parental Control functions are provided with the DVD.

Index (CD)/Video Index (VIDEO CD) (page 9)

A number that divides a track into sections to easily locate the point you want on a VIDEO CD or CD. Depending on the disc, no index may be recorded.

Parental Control (page 47)

A function of the DVD used to limit playback of the disc according to the age of the user and the limitation level in each country. The limitation varies from disc to disc; when it is activated, or playback is completely prohibited, violent scenes are skipped or replaced with other scenes, etc.

Region Code (page 6)

This system is used to protect copyrights. A region number is allocated on each DVD player or DVD disc according to the sales region. Each region code is shown on the player as well as on the disc packaging. The

player can play the discs that match its region code. This player can also play discs with the "R" mark. Even when the region code is not shown on the DVD, the region limit may still be activated.

Scene (page 9)

On a VIDEO CD with PBC (playback control) functions, the menu screens, moving pictures and still pictures are divided into sections called "scenes."

Title (page 9)

The longest section of a picture or music feature on a DVD, movie, etc., in video software, or the entire album in audio software.

Track (page 9)

Sections of a picture or a music feature on a VIDEO CD or CD (the length of a song).

TV Virtual Surround (TVS) (page 43)

Technology from Sony developed to produce surround sound for home use using just a stereo TV. Designed to work with the sound characteristics of your TV, this technology brings the excitement of surround sound to your home using nothing more than your stereo TV's internal speakers. Furthermore, various TVS modes are available. For example, TVS WIDE uses just two speakers to create a virtual sound environment that makes you feel like you are surrounded by multiple speakers.

Language Code List

For details, see page 42, 55, 45.

The language spellings conform to the ISO 639: 1988 (E/F) standard.

Code Language	Code Language	Code Language	Code Language
1027 Afar	1183 Irish	1347 Maori	1507 Samoan
1028 Abkhazian	1186 Scots Gaelic	1349 Macedonian	1508 Shona
1032 Afrikaans	1194 Galician	1350 Malayalam	1509 Somali
1039 Amharic	1196 Guarani	1352 Mongolian	1511 Albanian
1044 Arabic	1203 Gujarati	1353 Moldavian	1512 Serbian
1045 Assamese	1209 Hausa	1356 Marathi	1513 Siswati
1051 Aymara	1217 Hindi	1357 Malay	1514 Sesotho
1052 Azerbaijani	1226 Croatian	1358 Maltese	1515 Sundanese
1053 Bashkir	1229 Hungarian	1363 Burmese	1516 Swedish
1057 Byelorussian	1233 Armenian	1365 Nauru	1517 Swahili
1059 Bulgarian	1235 Interlingua	1369 Nepali	1521 Tamil
1060 Bihari	1239 Interlingue	1376 Dutch	1525 Telugu
1061 Bislama	1245 Inupiak	1379 Norwegian	1527 Tajik
1066 Bengali; Bangla	1248 Indonesian	1393 Occitan	1528 Thai
1067 Tibetan	1253 Icelandic	1403 (Afan)Oromo	1529 Tigrinya
1070 Breton	1254 Italian	1408 Oriya	1531 Turkmen
1079 Catalan	1257 Hebrew	1417 Punjabi	1532 Tagalog
1093 Corsican	1261 Japanese	1428 Polish	1534 Setswana
1097 Czech	1269 Yiddish	1435 Pashto; Pushto	1535 Tonga
1103 Welsh	1283 Javanese	1436 Portuguese	1538 Turkish
1105 Danish	1287 Georgian	1463 Quechua	1539 Tsonga
1109 German	1297 Kazakh	1481 Rhaeto-Romance	1540 Tatar
1130 Bhutani	1298 Greenlandic	1482 Kirundi	1543 Twi
1142 Greek	1299 Cambodian	1483 Romanian	1557 Ukrainian
1144 English	1300 Kannada	1489 Russian	1564 Urdu
1145 Esperanto	1301 Korean	1491 Kiryavanda	1572 Uzbek
1149 Spanish	1305 Kashmiri	1495 Sanskrit	1581 Vietnamese
1150 Estonian	1307 Kurdish	1498 Sindhi	1587 Volapük
1151 Basque	1311 Kirghiz	1498 Sindhi	1613 Wolof
1157 Persian	1313 Latin	1501 Sangho	1632 Xhosa
1165 Finnish	1326 Lingala	1502 Serbo-Croatian	1665 Yoruba
1166 Fiji	1327 Laothian	1503 Singhalese	1684 Chinese
1171 Faroese	1332 Lithuanian	1505 Slovak	1697 Zulu
1174 French	1334 Latvian; Lettish	1506 Slovenian	
1181 Frisian	1345 Malagasy		1703 Not specified

Additional Information

67 68

CUSTOM SETUP (page 57)

AUTO PLAY	OFF TIMER DEMO1 DEMO2
DIMMER	BRIGHT DARK OFF
PAUSE MODE	AUTO FRAME
PARENTAL CONTROL →	
TRACK SELECTION	OFF AUTO

AUDIO SETUP (page 58)

AUDIO ATT	OFF ON		
AUDIO DRC	STANDARD TV MODE WIDE RANGE		
DOWNMIX	DOLBY SURROUND NORMAL		
DIGITAL OUT	ON	DOLBY DIGITAL	D-PCM DOLBY DIGITAL
		DTS	OFF ON
	OFF		

Additional Information

69 70

1-16 E

List of Setup Display Items

The default settings are underlined.

LANGUAGE SETUP (page 55)

OSD	<u>ENGLISH</u> FRENCH SPANISH PORTUGUESE
DVD MENU	<u>ENGLISH</u> FRENCH SPANISH PORTUGUESE GERMAN ITALIAN DUTCH CHINESE JAPANESE DANISH SWEDISH FINNISH NORWEGIAN RUSSIAN OTHERS →
AUDIO	<u>ORIGINAL</u> (All other selections are same as the DVD MENU language.)
SUBTITLE	<u>AUDIO FOLLOW</u> (All other selections are same as the DVD MENU language.)

SCREEN SETUP (page 56)

TV TYPE	<u>4:3 LETTER BOX</u> 4:3 PAN SCAN 16:9
SCREEN SAVER	ON OFF
BACKGROUND	<u>JACKET PICTURE</u> GRAPHICS BLUE BLACK

Index

Numerics

16:9 56
4:3 LETTER BOX 56
4:3 PAN SCAN 56
5.1 Channel Surround 23

A

A-B Repeat 36
ANGLE 45
AUDIO 55
AUDIO ATT 58
AUDIO DRC 58
AUDIO SETUP 58
AUTO PLAY 57

B

BACKGROUND 57
BATTERIES 14
BNR 46

C

CD 28
CHAPTER 38
Chapter 64
Connecting 17
Continuous play
CD/VIDEO
CD/DVD 28
Control Bar 13
Control Menu 13
CUSTOM 54
CUSTOM PARENTAL
CONTROL 47
CUSTOM SETUP 57

D

DIGITAL OUT 59
Digital output 59
DIMMER 57
Display
Control Menu display 13
Front panel display 9
Setup Display 12
DOLBY DIGITAL 22, 43, 59
DOWNMIX 59
DTS 22, 42, 60
DVD 28, 64
DVD MENU 55

DVD menu 31

F

Fast forward 37
Fast reverse 37
Front Panel display 9

H

Handling discs 7
Hooking up 17

I

INDEX 38
Index 38
INSTANT REPLAY 29

L

LANGUAGE SETUP 55
Locating
a specific point by
watching the TV screen 37

N

Number input 38

O

On-screen display
Control Menu display 13
Setup Display 54
OSD 68

P

PARENTAL CONTROL 47, 58
PAUSE MODE 58
PBC Playback 32
PROGRAM 33
Program Play 33

Q

QUICK 55
Quick Setup 24

R

Remote 14, 53
REPEAT 35
RESET 55

Resume Play 30

S

S VIDEO output 17
SCENE 38
Scene 65
SCREEN SAVER 57
SCREEN SETUP 56
Setup Display 54
SHUFFLE 35
Shuffle Play 35
Slow-motion play 37
Speakers hookup 21
Status Bar 12
SUBTITLE 55
Subtitles 45
SURROUND 43

T

TIME/TEXT 39
TITLE 38
Title 65
Title menu 31
TRACK 38
Track 65
TRACK SELECTION 58
Troubleshooting 61
TV TYPE 56
TVS (TV Virtual Surround) 43

U

Usable discs 6

V

VIDEO CD 28

69 70

SECTION 2 DISASSEMBLY

Note: Follow the disassembly procedure in the numerical order given.

2-1. CASE REMOVAL

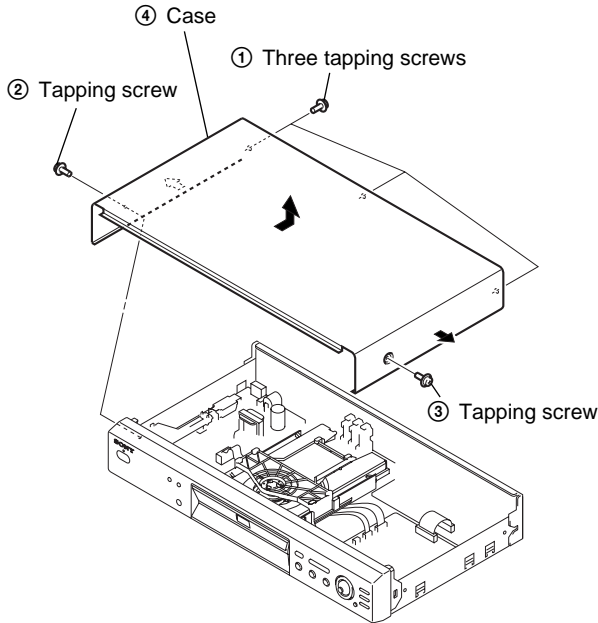

2-3. ER-14 BOARD REMOVAL (AEP, UK, Russian)

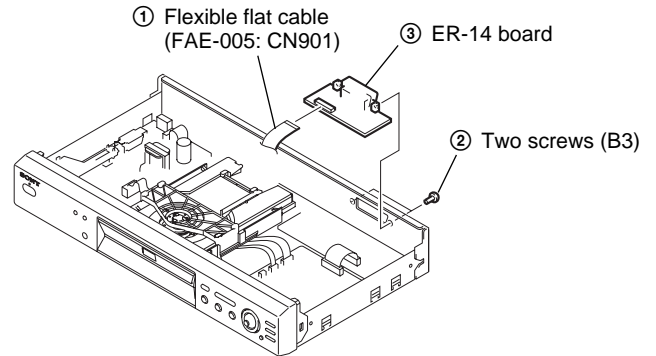

2-2. MB-98 BOARD REMOVAL

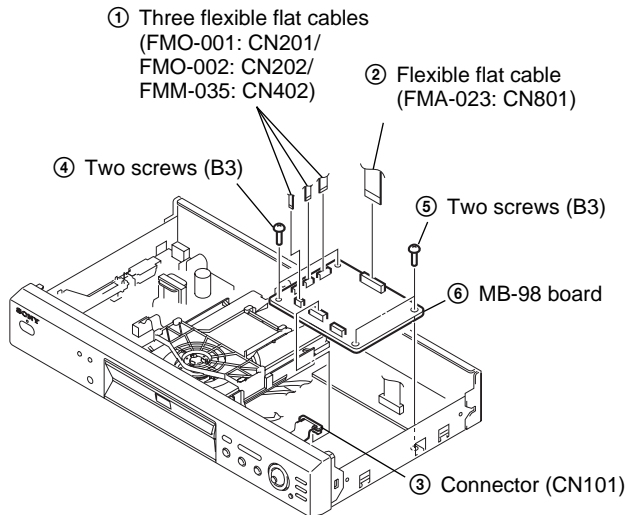

2-4. REAR PANEL REMOVAL

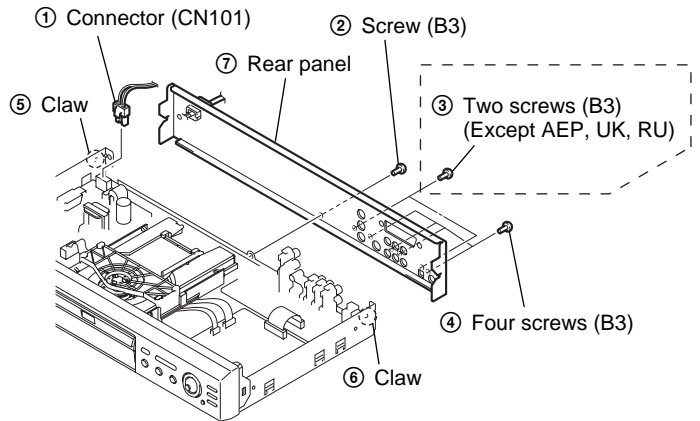

2-5. AV-56 BOARD REMOVAL

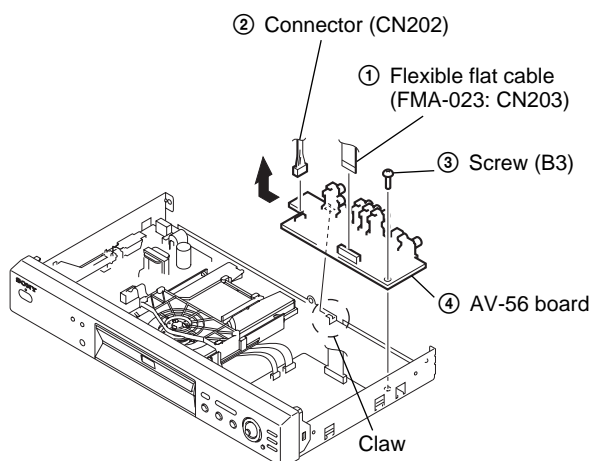

2-7. FRONT PANEL REMOVAL

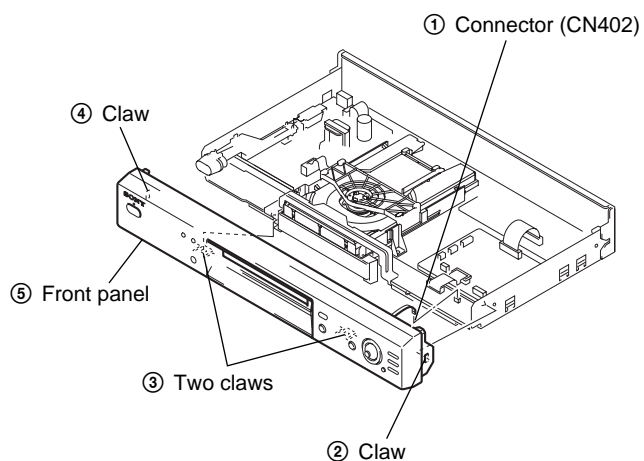

2-6. TRAY COVER REMOVAL

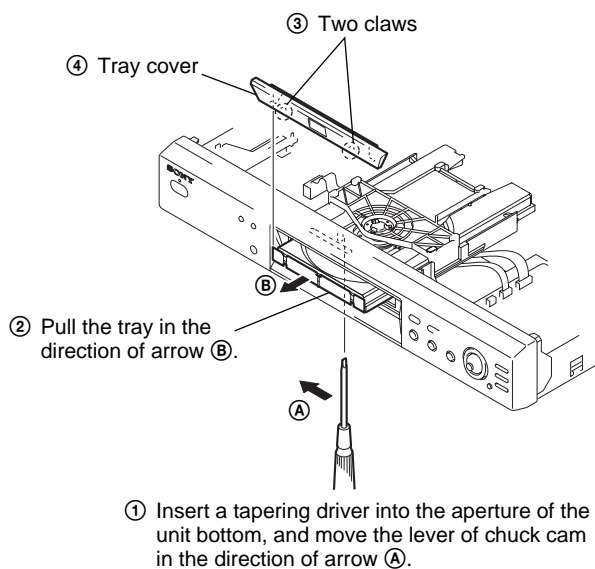

2-8. POWER BLOCK REMOVAL

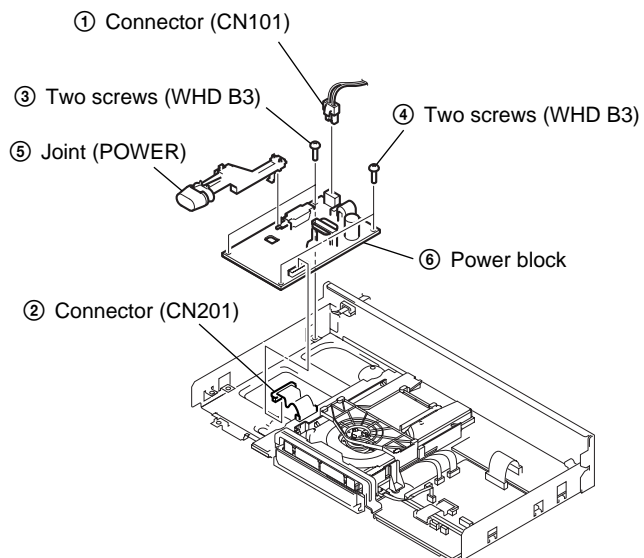

2-9. MECHANISM DECK REMOVAL

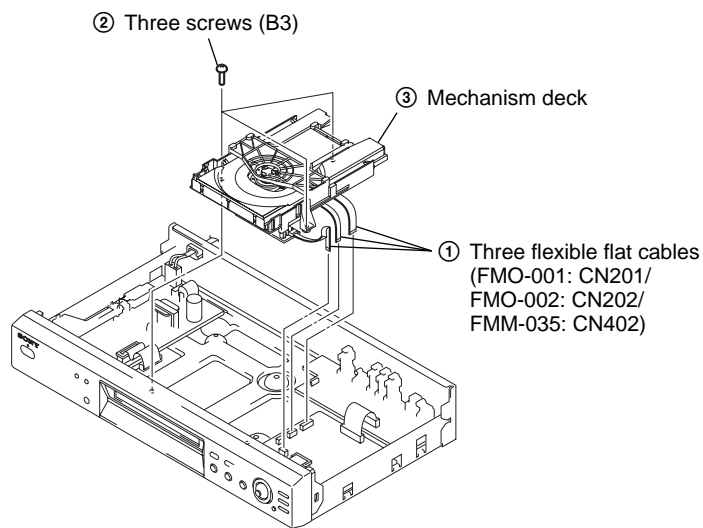

2-11. LOADING MOTOR (M001), MS-81 BOARD REMOVAL

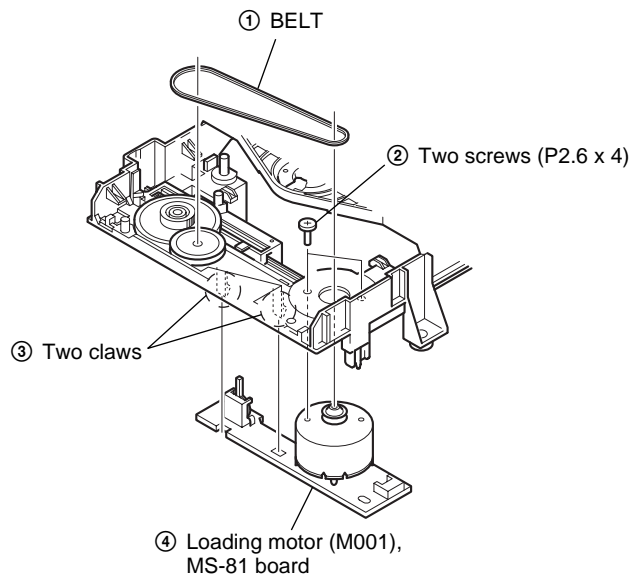

2-10. TRAY REMOVAL

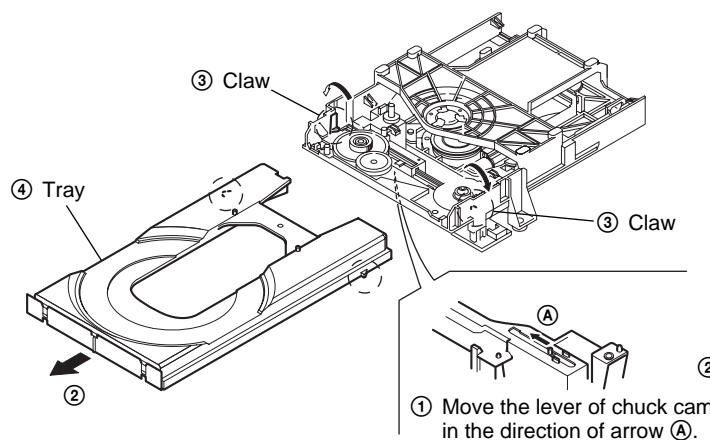

2-12. OPTICAL PICK-UP REMOVAL

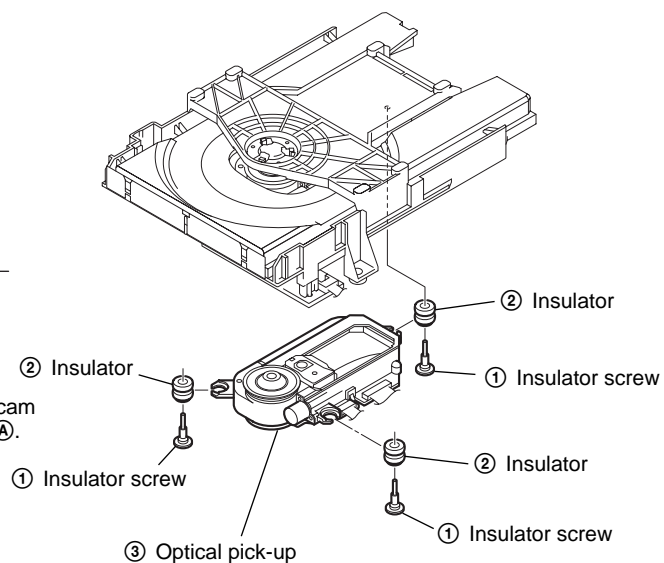

2-13. IF-80 BOARD REMOVAL

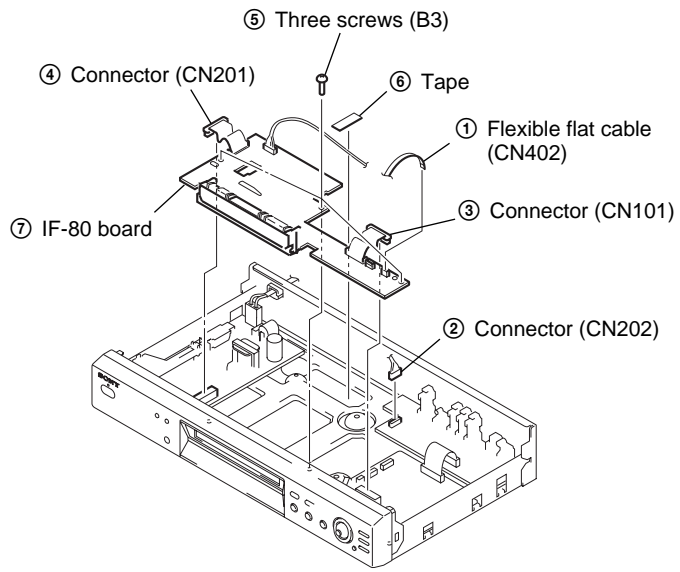

2-14. INTERNAL VIEWS

DC motor (loading)
1-541-632-11

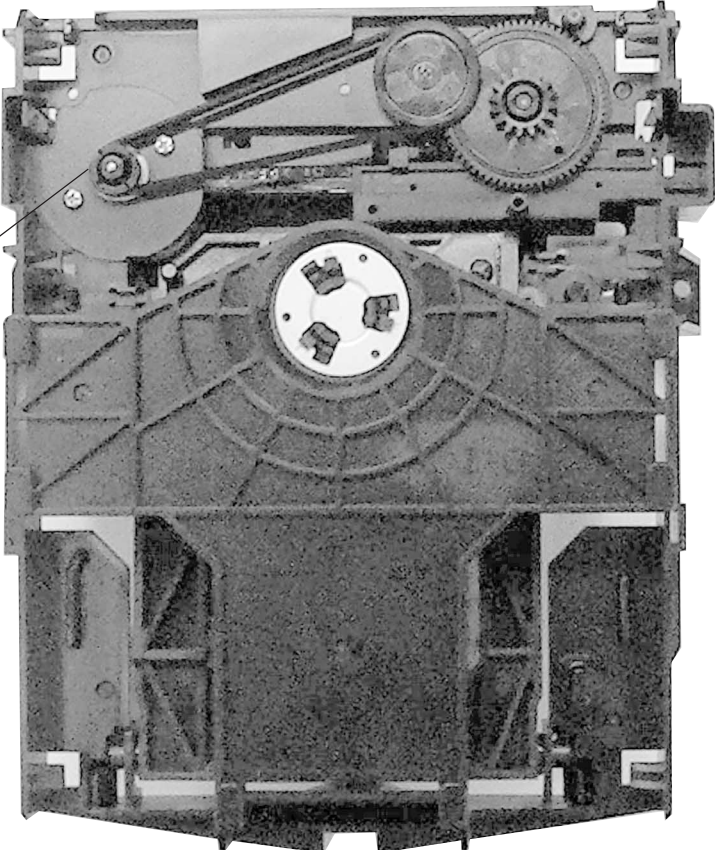

DC motor (loading)
1-541-632-11

Optical pick-up
(KHM-250 AAA/J1NP)
A-4900-650-A

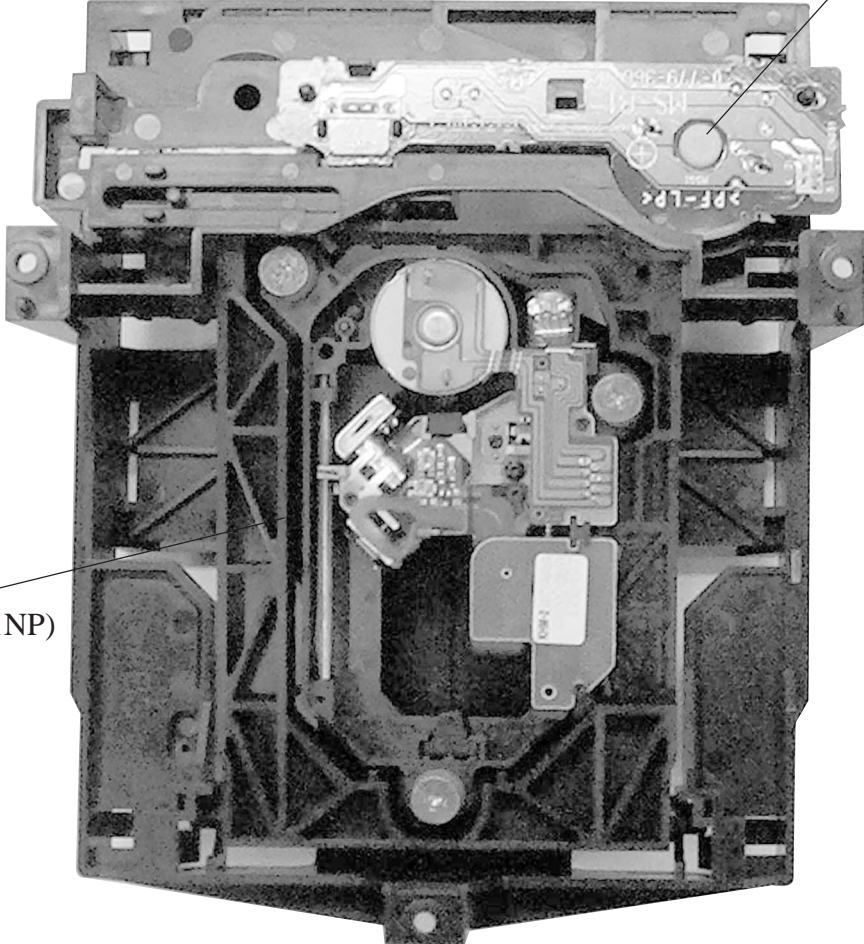

2-15. CIRCUIT BOARDS LOCATION

Power Block (TOP-244U)

(US, Canadian, Mexican)

Power Block (HS13S0U)

(US, Canadian, Mexican, Taiwan)

Power Block (HS13S0E)

(AEP, UK, Russian, 220-240V AC Area in E, Saudi Arabia, Middle East, Argentina, Hong Kong, Korea, Singapore, Australian)

Power Block (HS13S0F)

(110-240V AC Area in E, Brazilian, PX)

(SWITCHING REGULATOR)

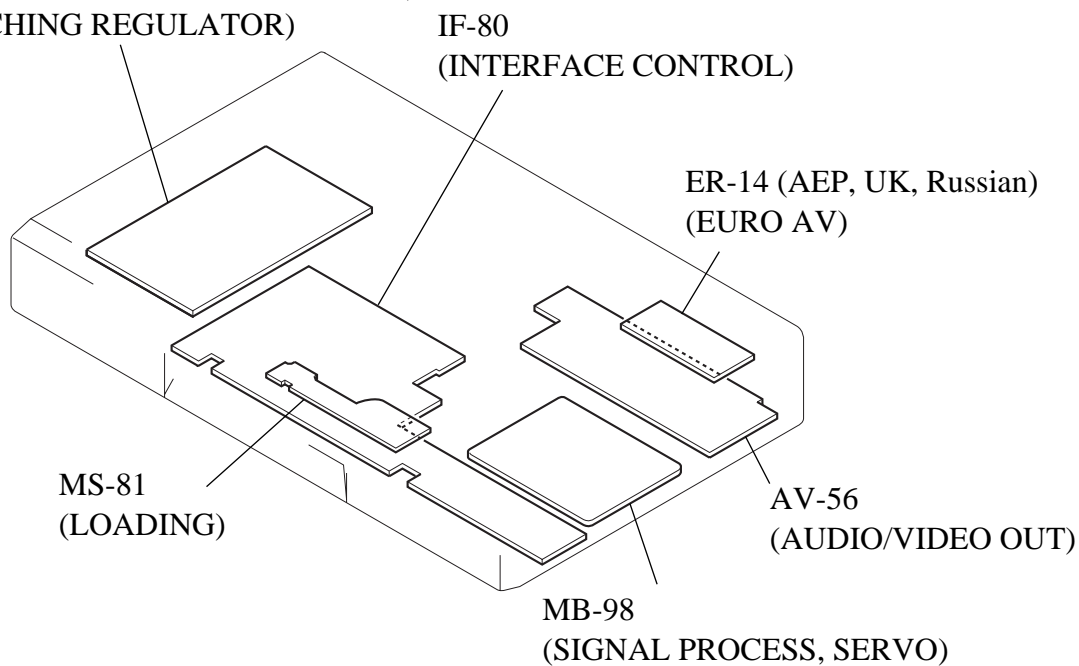

SECTION 3 BLOCK DIAGRAMS

3-1. OVERALL BLOCK DIAGRAM

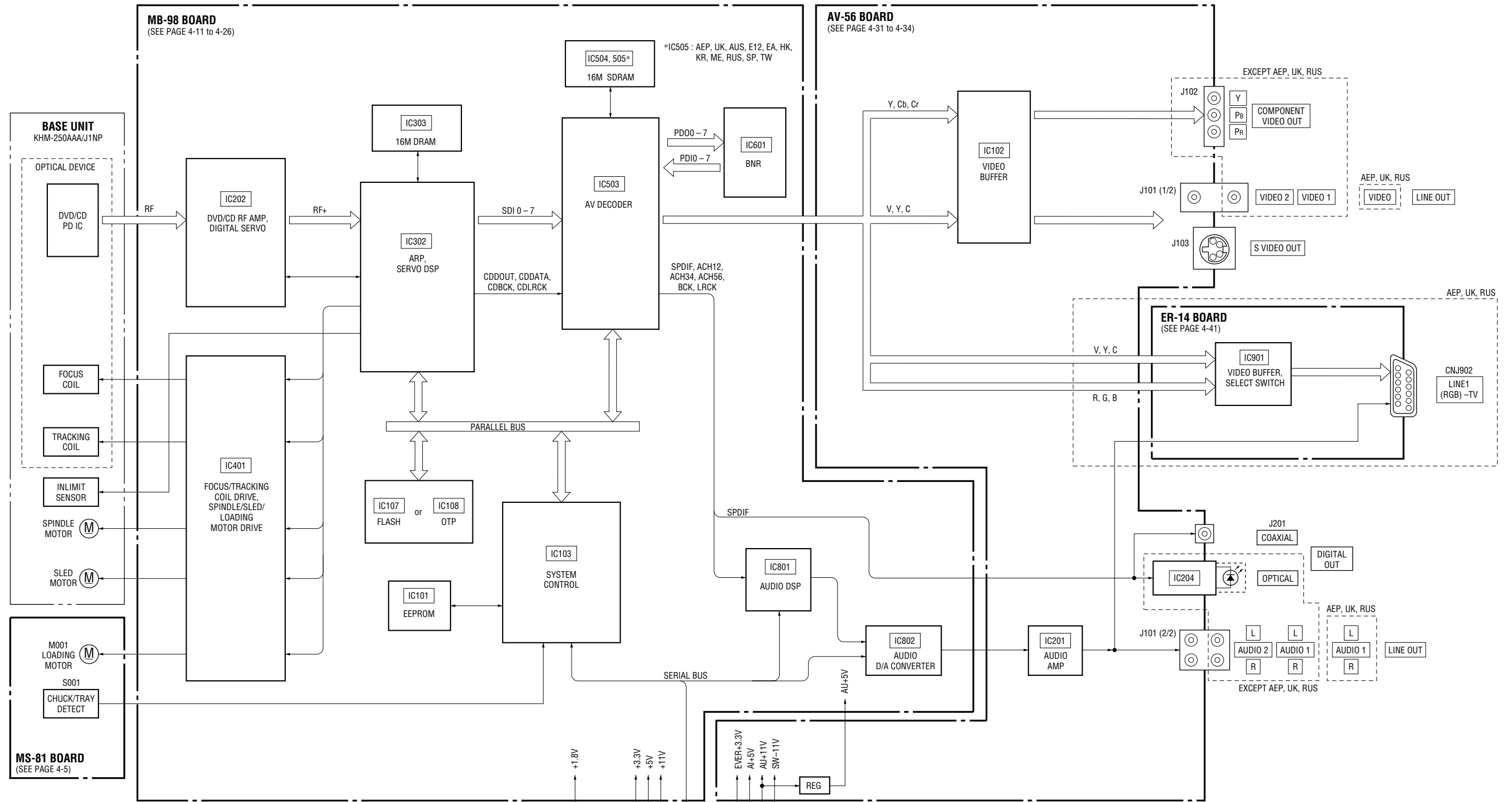

- Abbreviation
- AR : Argentina
- AUS : Australian
- BR : Brazilian
- CND : Canadian
- E12 : 220 — 240 V AC Area in E
- E32 : 110 — 240 V AC Area in E
- EA : Saudi Arabia
- HK : Hong Kong
- KR : Korea
- ME : Middle East
- MX : Mexican
- RUS : Russian
- SP : Singapore
- TW : Taiwan

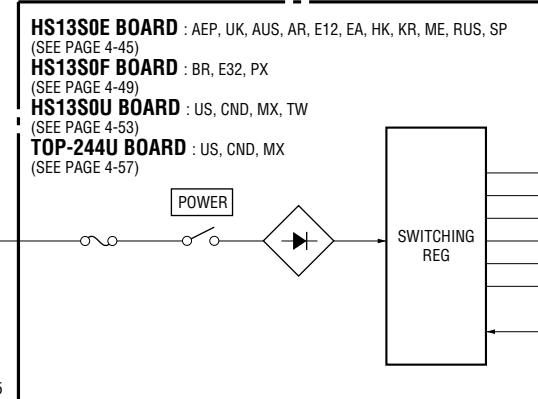

05

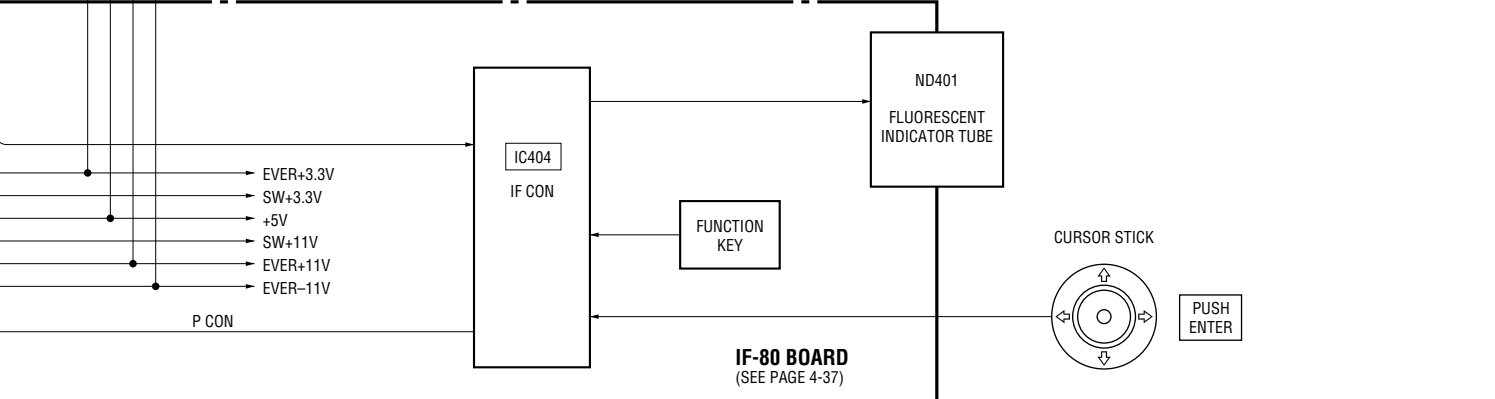

3-2. RF/SERVO BLOCK DIAGRAM

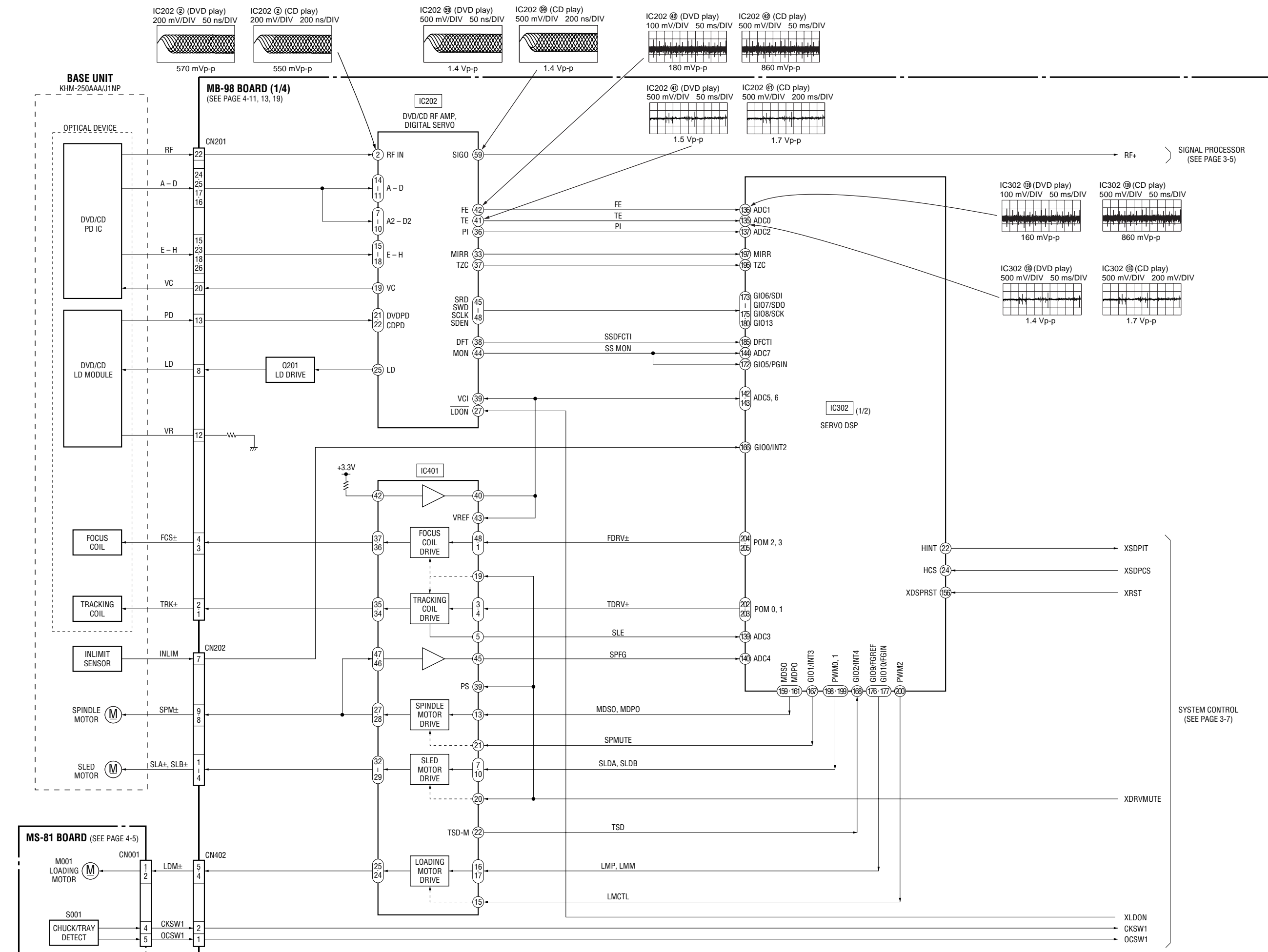

3-3. SIGNAL PROCESSOR BLOCK DIAGRAM

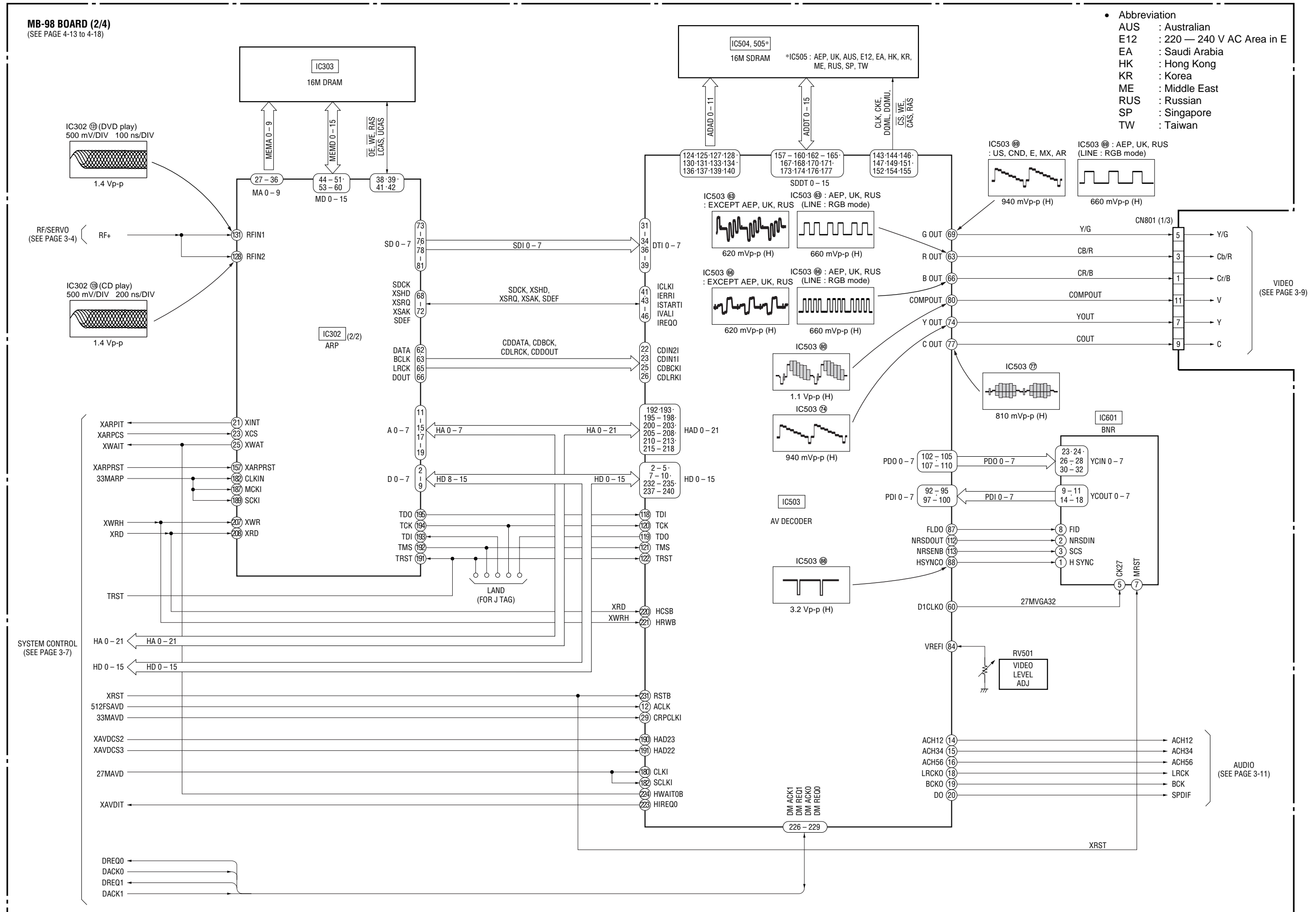

3-4. SYSTEM CONTROL BLOCK DIAGRAM

MB-98 BOARD (3/4)
(SEE PAGE 4-21 to 4-24)

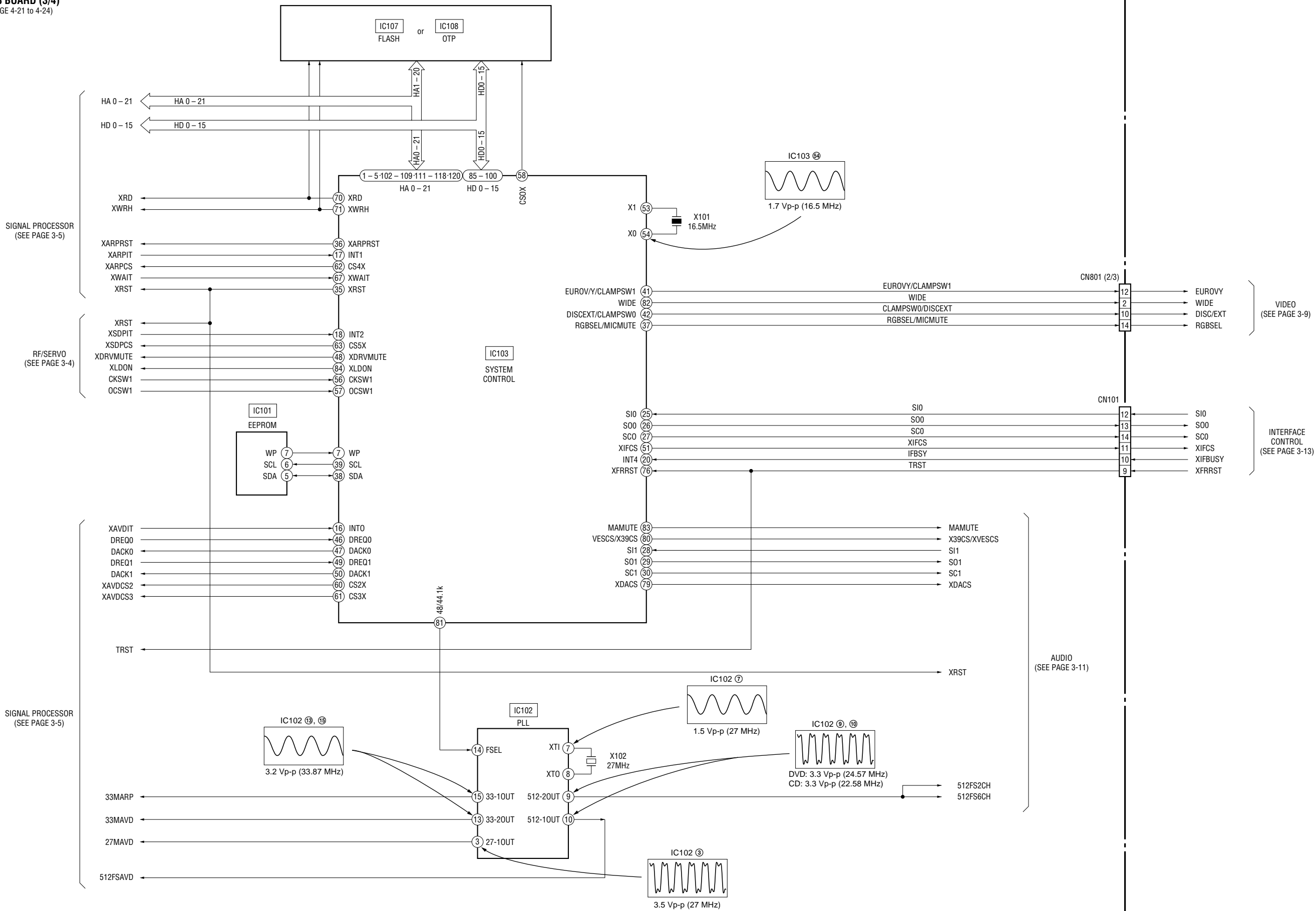

3-5. VIDEO BLOCK DIAGRAM

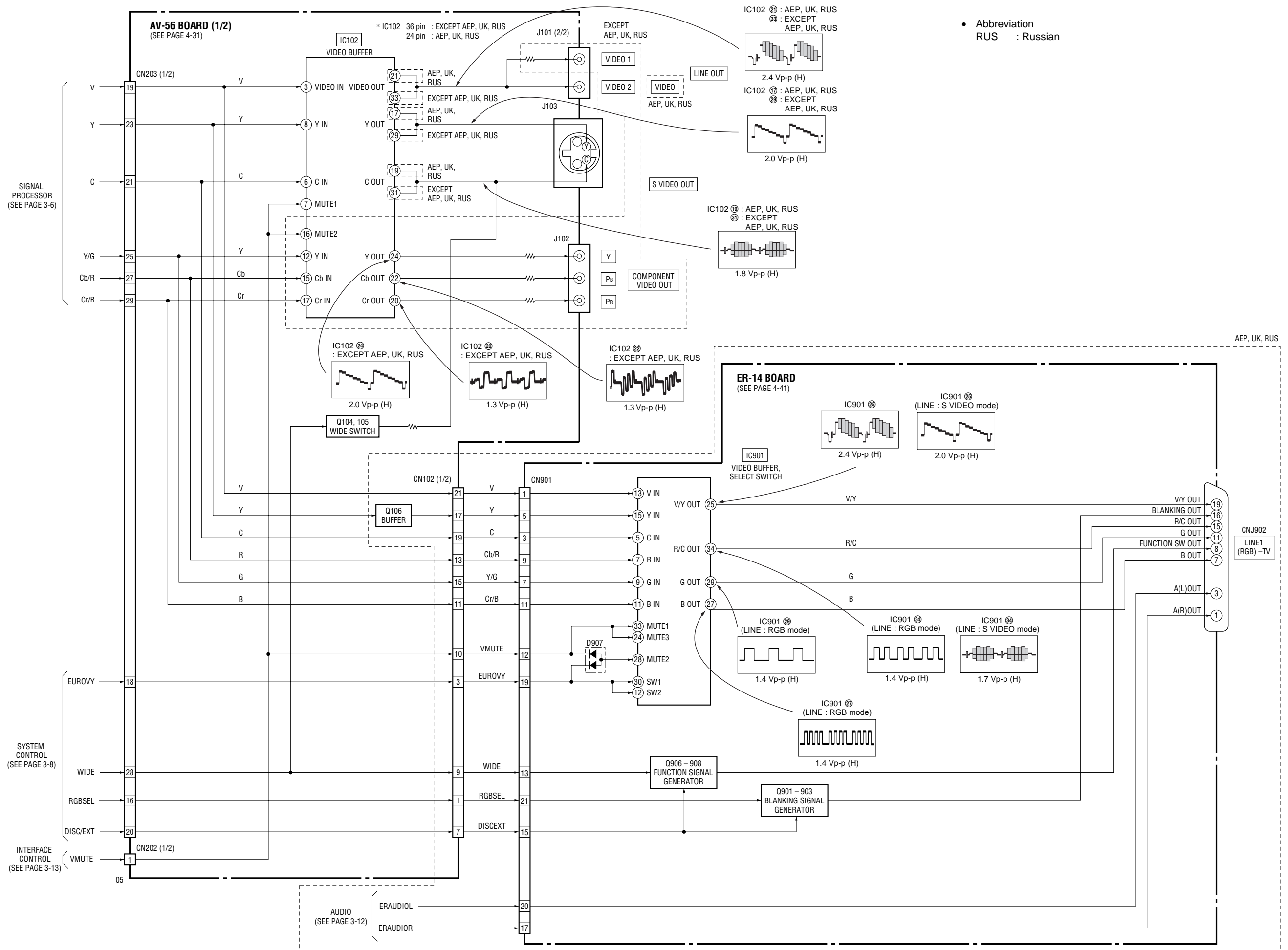

3-6. AUDIO BLOCK DIAGRAM

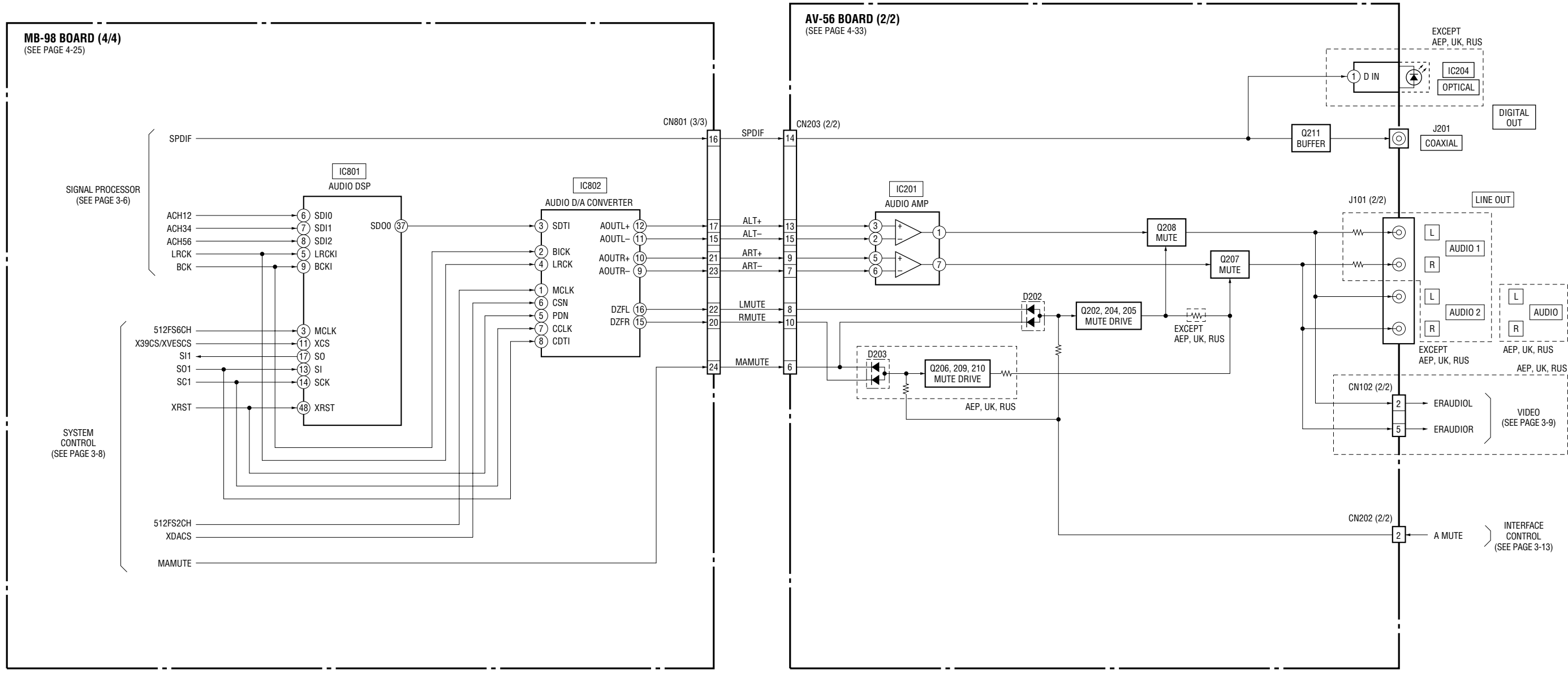

05

• Abbreviation
RUS : Russian

3-7. INTERFACE CONTROL BLOCK DIAGRAM

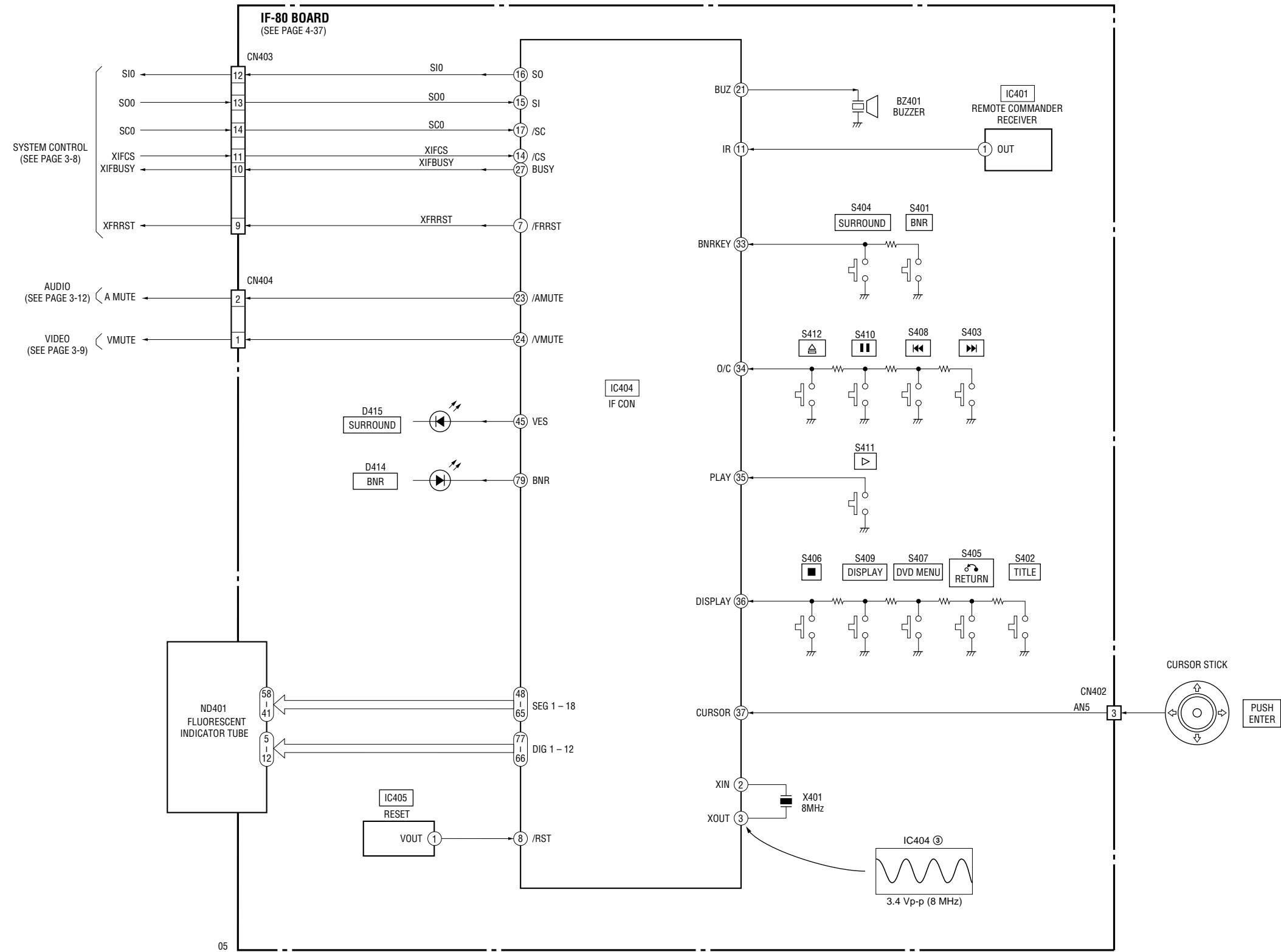

3-8. POWER 1 BLOCK DIAGRAM

EXCEPT BR, E32, PX

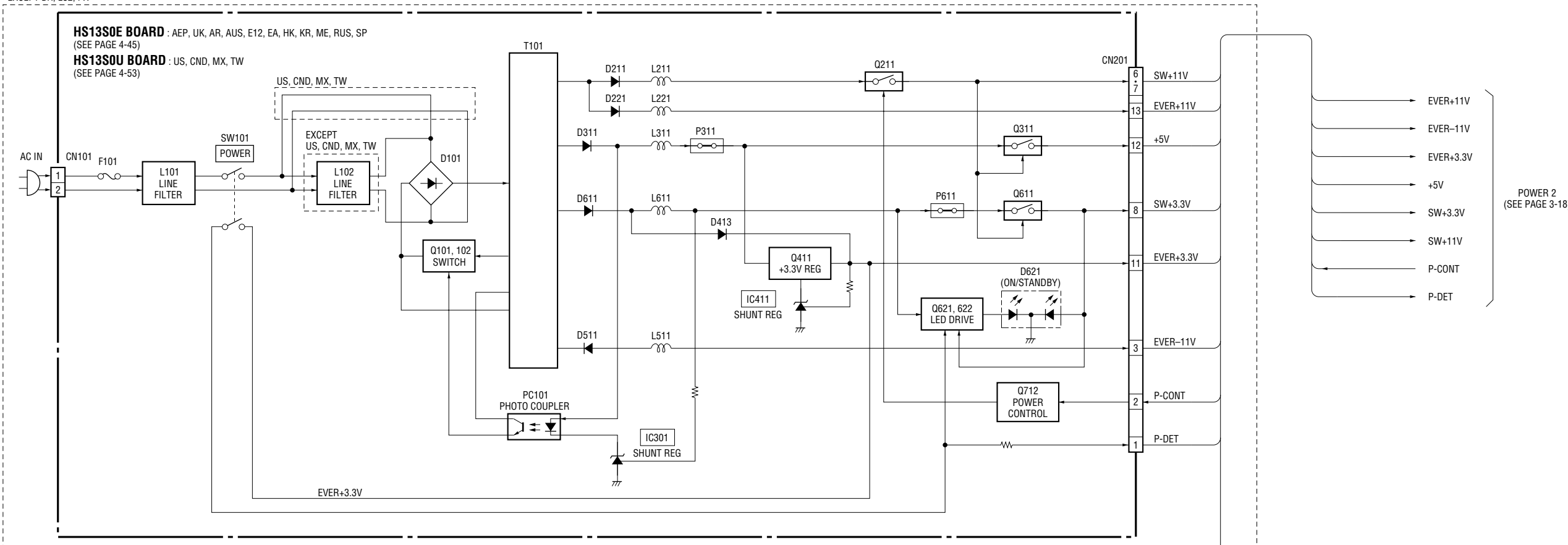

US, CND, MX

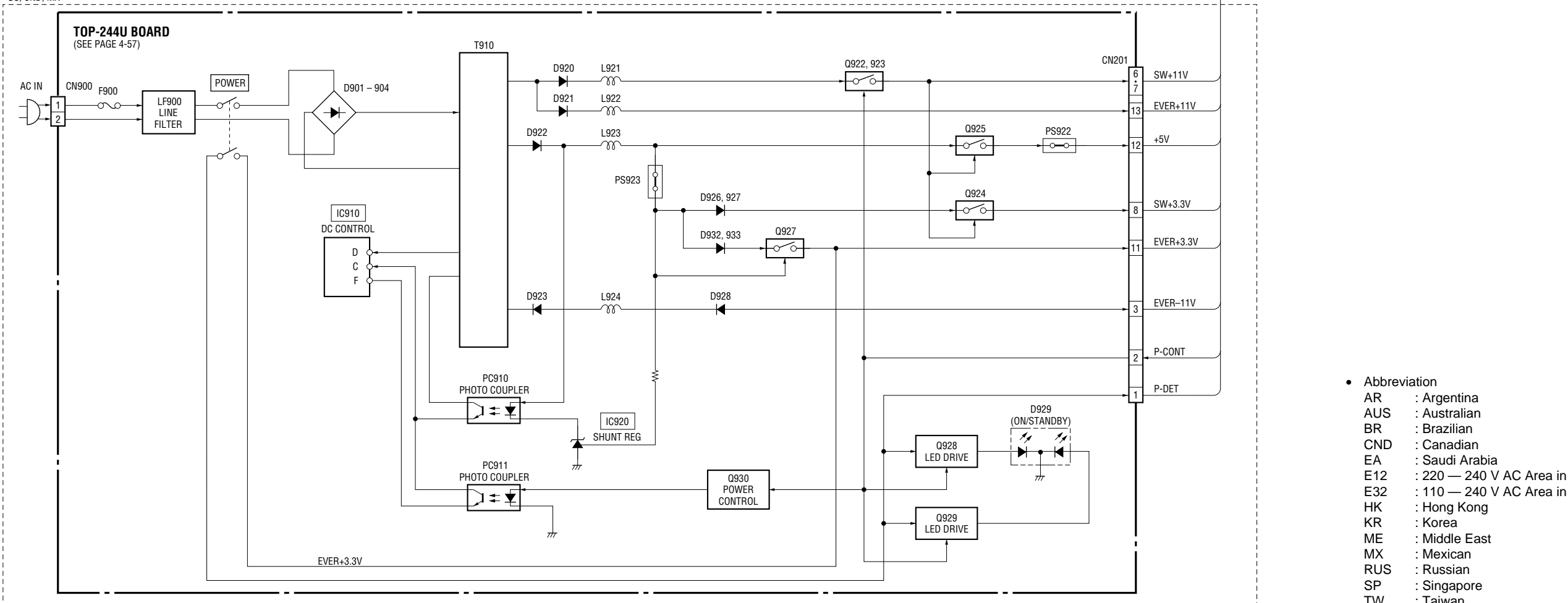

- Abbreviation
- AR : Argentina
- AUS : Australian
- BR : Brazilian
- CND : Canadian
- EA : Saudi Arabia
- E12 : 220 — 240 V AC Area in E
- E32 : 110 — 240 V AC Area in E
- HK : Hong Kong
- KR : Korea
- ME : Middle East
- MX : Mexican
- RUS : Russian
- SP : Singapore
- TW : Taiwan

3-9. POWER 2 BLOCK DIAGRAM

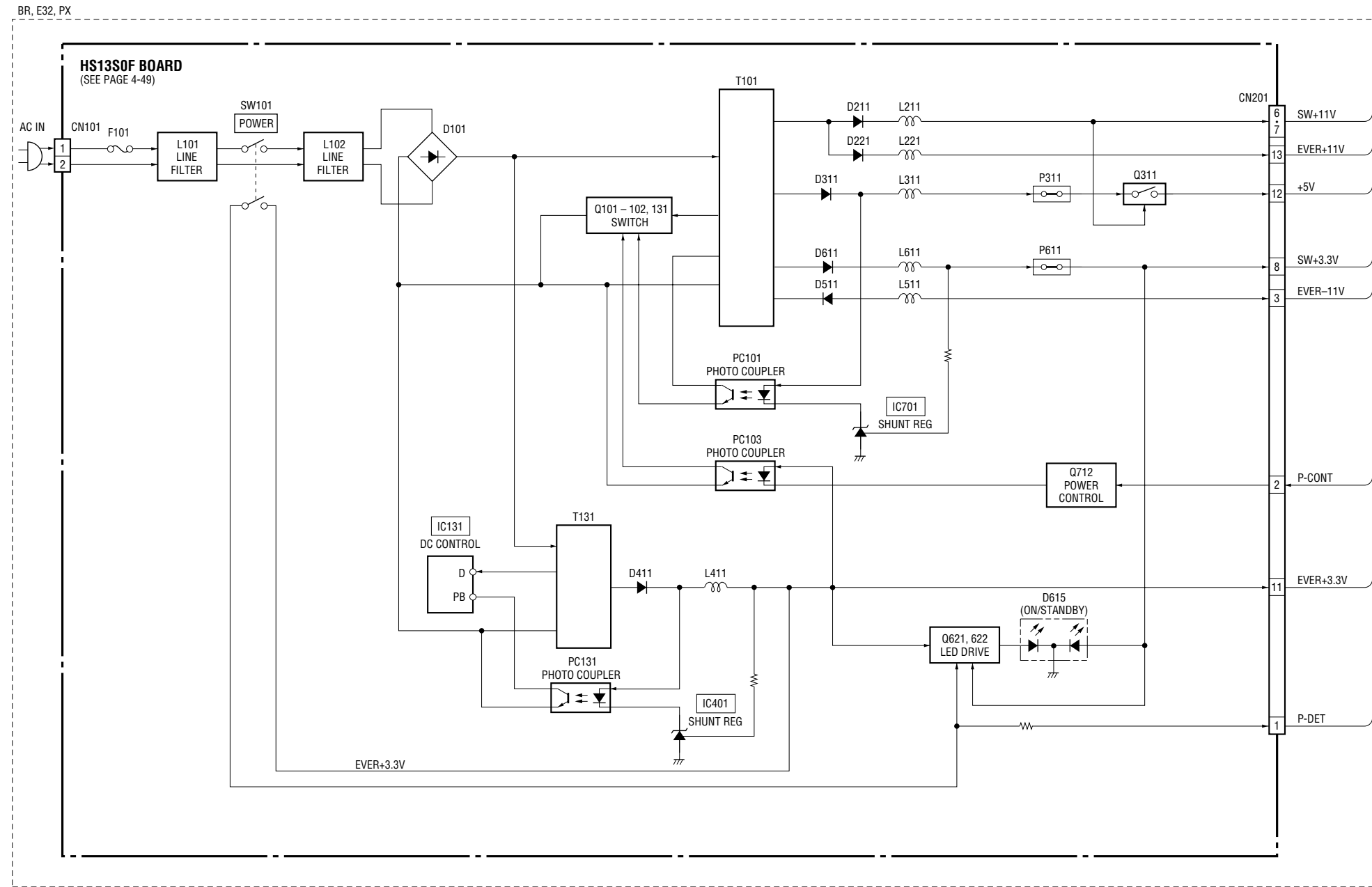

- Abbreviation
- BR : Brazilian
- E32 : 110 — 240 V AC Area in E

POWER 1
(SEE PAGE 3-16)

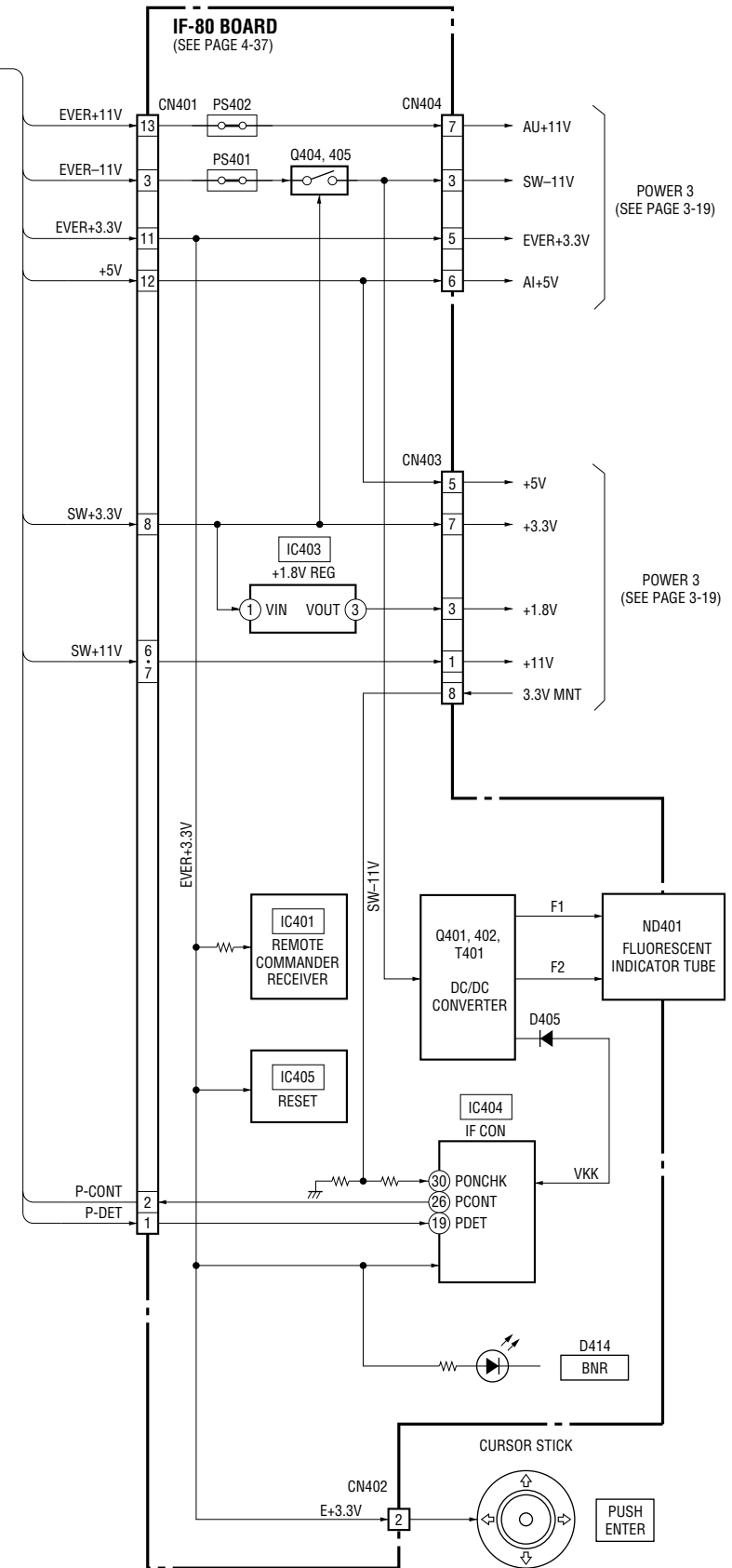
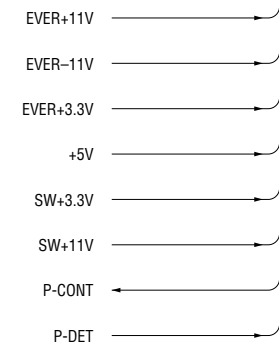

3-10. POWER 3 BLOCK DIAGRAM

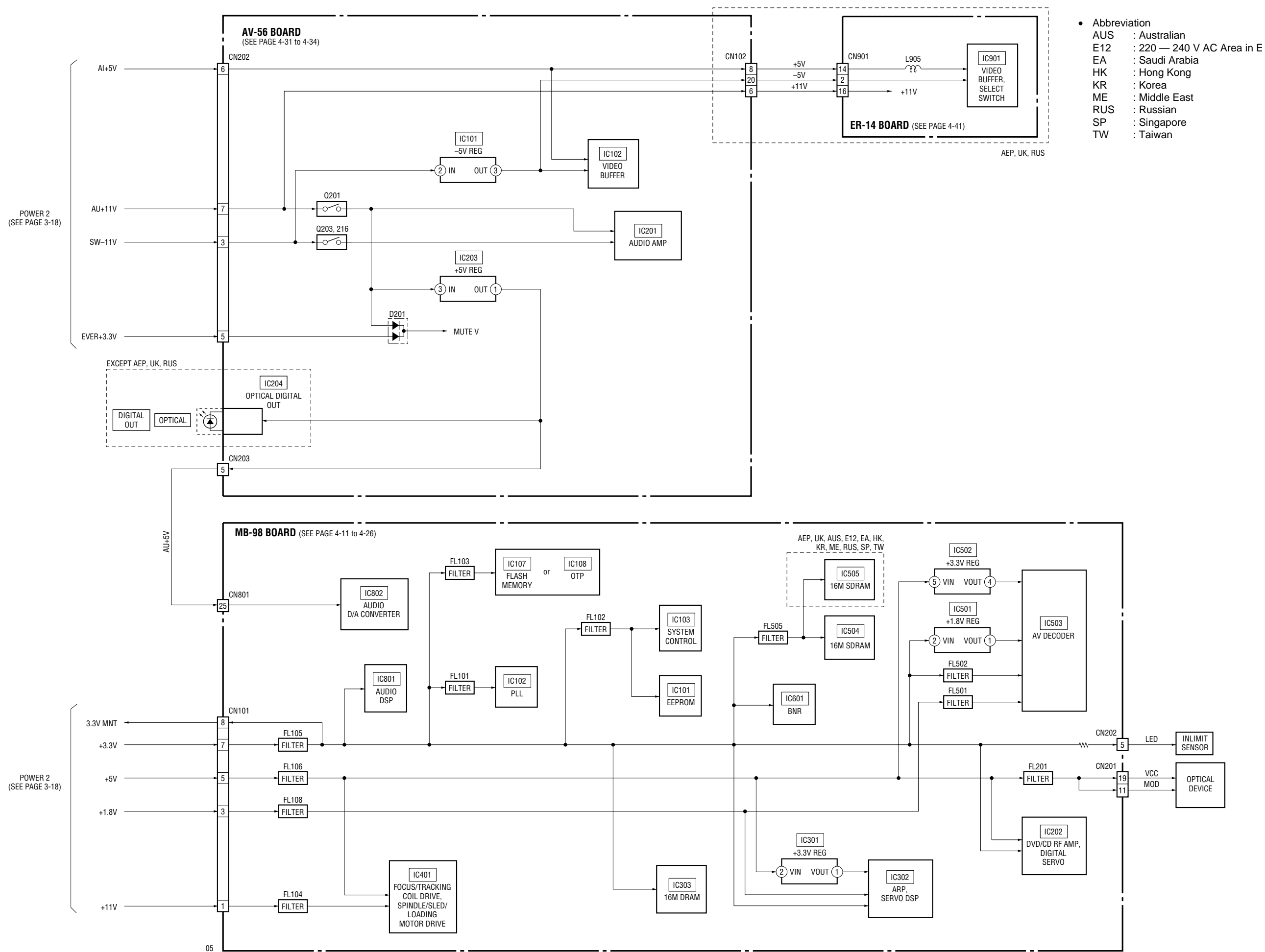





- Abbreviation
- AUS : Australian
- E12 : 220 — 240 V AC Area in E
- EA : Saudi Arabia
- HK : Hong Kong
- KR : Korea
- ME : Middle East
- RUS : Russian
- SP : Singapore
- TW : Taiwan

SECTION 4 PRINTED WIRING BOARDS AND SCHEMATIC DIAGRAMS







**THIS NOTE IS COMMON FOR PRINTED WIRING BOARDS AND SCHEMATIC DIAGRAMS.
(In addition to this, the necessary note is printed in each block.)**

For printed wiring boards:

-  : indicates a lead wire mounted on the component side.
-  : indicates a lead wire mounted on the printed side.
-  : Through hole.
-  : Pattern from the side which enables seeing.
(The other layers' patterns are not indicated.)

Caution:
 Pattern face side: Parts on the pattern face side seen from the pattern face are indicated.
 (Side A)
 Parts face side: Parts on the parts face side seen from the parts face are indicated.
 (Side B)

For schematic diagram:

- Caution when replacing chip parts.
New parts must be attached after removal of chip.
Be careful not to heat the minus side of tantalum capacitor, because it is damaged by the heat.
- All resistors are in ohms, $\frac{1}{4}W$ (Chip resistors : $\frac{1}{10}W$) unless otherwise specified.
k Ω : 1000 Ω , M Ω : 1000k Ω .
- All capacitors are in μF unless otherwise noted. pF : $\mu\mu F$
50V or less are not indicated except for electrolytics and tantalums.
- All variable and adjustable resistors have characteristic curve B, unless otherwise noted.
-  : nonflammable resistor.
-  : fusible resistor.
-  : panel designation.
-  : internal component.
-  : adjustment for repair.
-  : B+ Line.
-  : B- Line.
- Circled numbers refer to waveforms.
- Voltages are dc between measurement point.
- Readings are taken with a color-bar signal on DVD reference disc and when playing CD reference disc.
- Readings are taken with a digital multimeter (DC 10M Ω).
- Voltage variations may be noted due to normal production tolerances.

<p>Note: The components identified by mark \triangle or dotted line with mark \triangle are critical for safety. Replace only with part number specified.</p>	<p>Note: Les composants identifiés par une marque \triangle sont critiques pour la sécurité. Ne les remplacer que par une pièce portant le numéro spécifié.</p>
--	---

When indicating parts by reference number, please include the board name.

- Abbreviation
 AR : Argentina
 AUS : Australian
 BR : Brazilian
 CND : Canadian
 E12 : 220-240 V AC Area in E
 E32 : 110-240 V AC Area in E
 EA : Saudi Arabia
 HK : Hong Kong
 KR : Korea
 ME : Middle East
 MX : Mexican
 RUS : Russian
 SP : Singapore
 TW : Taiwan

• Description about model name

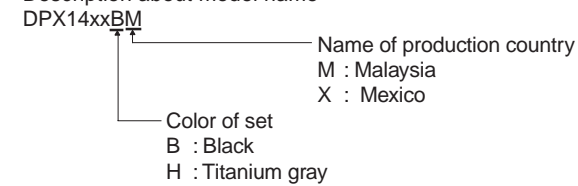

4-1. FRAME SCHEMATIC DIAGRAM

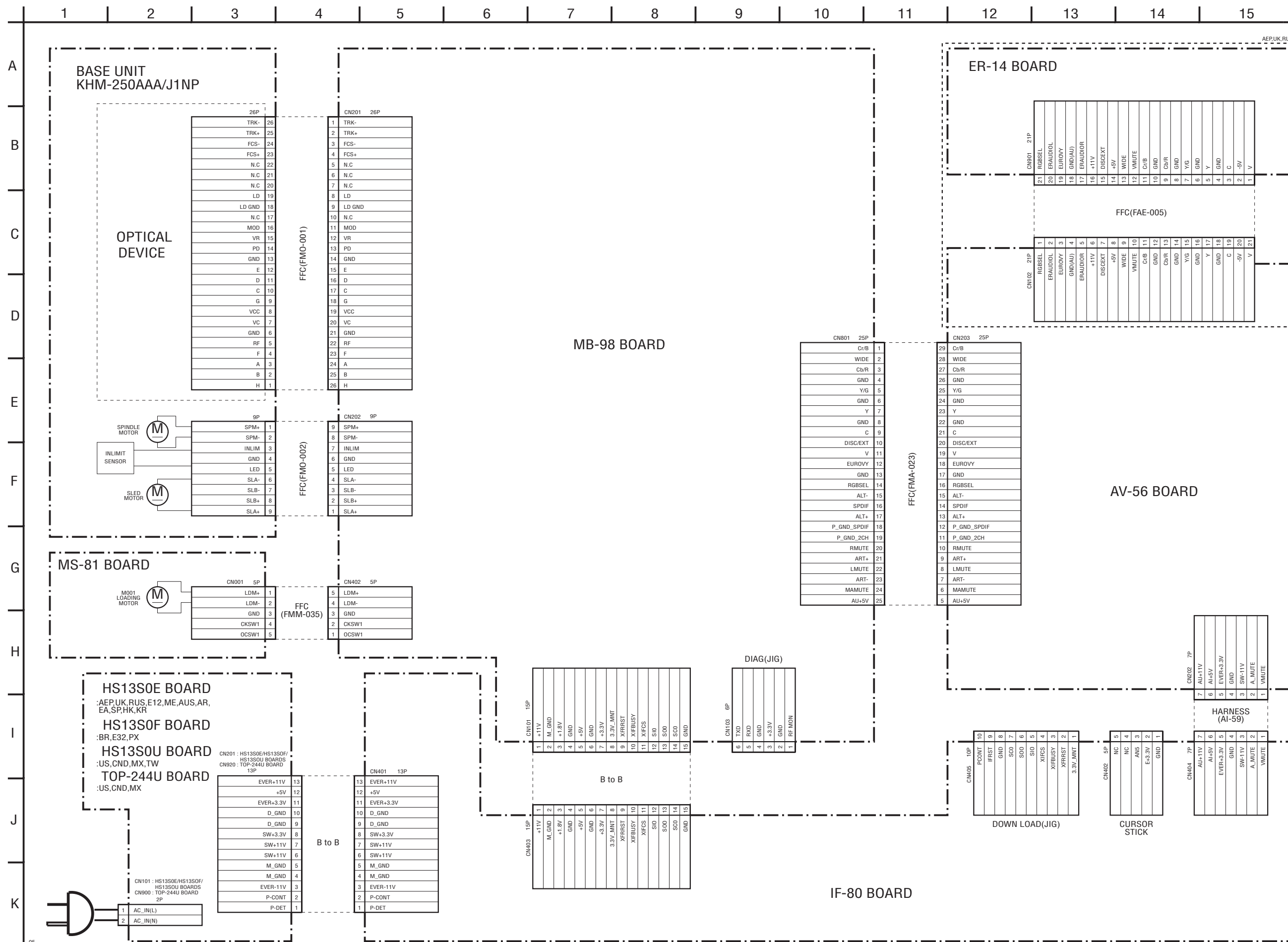

4-2. PRINTED WIRING BOARDS AND SCHEMATIC DIAGRAMS

MS-81 (LOADING) PRINTED WIRING BOARD AND SCHEMATIC DIAGRAM

– Ref. No.: MS-81 board; 1,000 series –

There are a few cases that the part isn't mounted in this model is printed on this diagram.

MS-81 BOARD

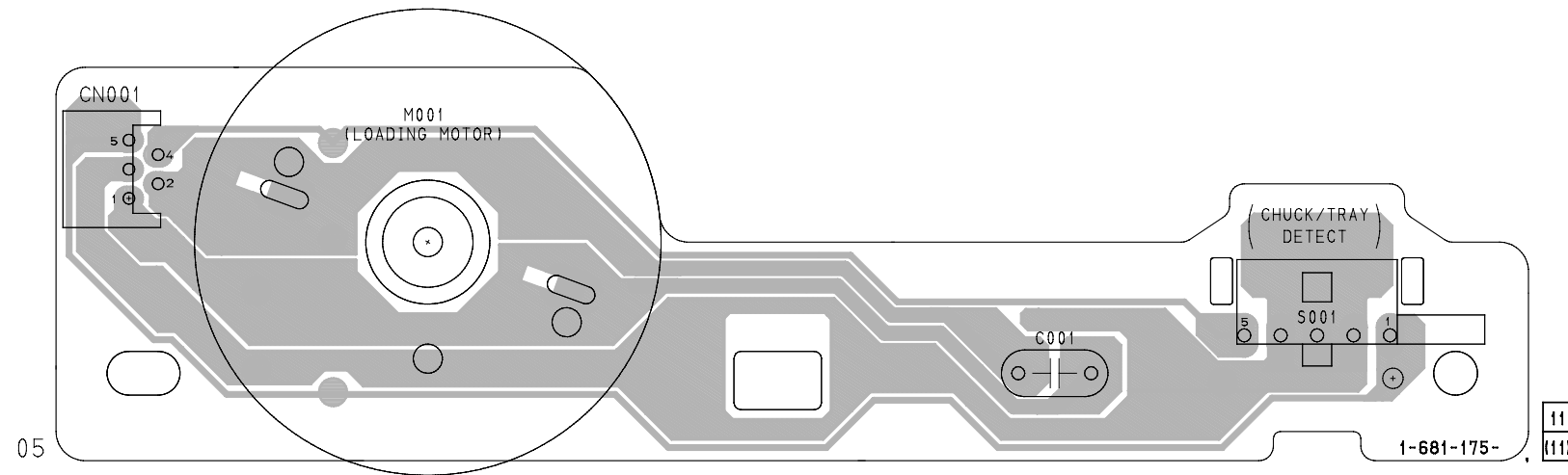

- Power Block (TOP-244U)
(US, Canadian, Mexican)
- Power Block (HS13S0U)
(US, Canadian, Mexican, Taiwan)
- Power Block (HS13S0E)
(AEP, UK, Russian, 220-240V AC Area in E, Saudi Arabia, Middle East, Argentina, Hong Kong, Korea, Singapore, Australian)
- Power Block (HS13S0F)
(110-240V AC Area in E, Brazilian, PX)
- (SWITCHING REGULATOR)

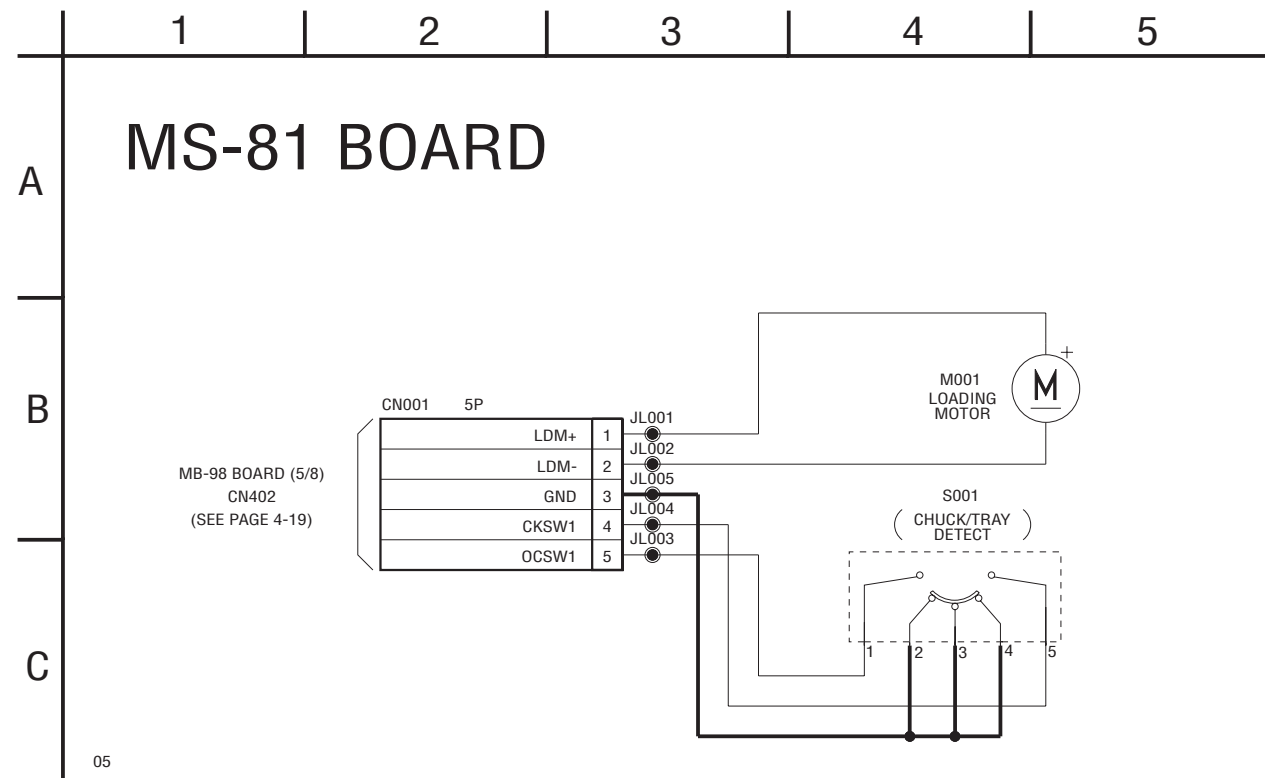
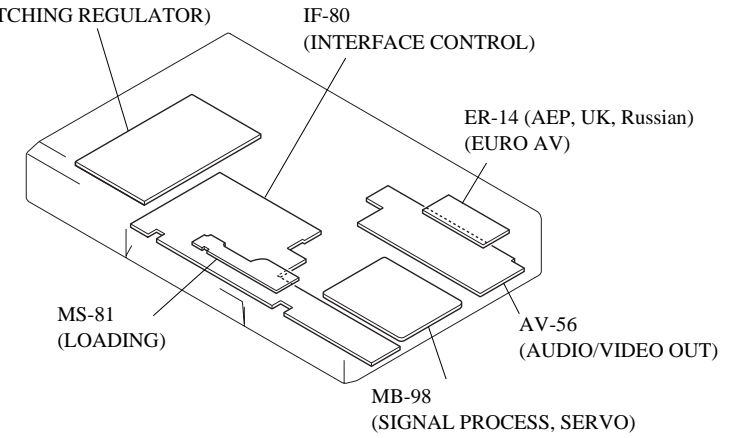

MB-98 (SIGNAL PROCESS, SERVO) PRINTED WIRING BOARD

– Ref. No.: MB-98 board; 2,000 series –

There are a few cases that the part isn't mounted in this model is printed on this diagram.

MB-98 BOARD (SIDE A)

- CN101 D-3
- CN103 D-4
- CN201 A-1
- CN202 C-1
- CN402 D-1
- CN801 A-3

- IC103 C-5
- IC302 B-2
- IC503 C-3

MB-98 BOARD (SIDE A)

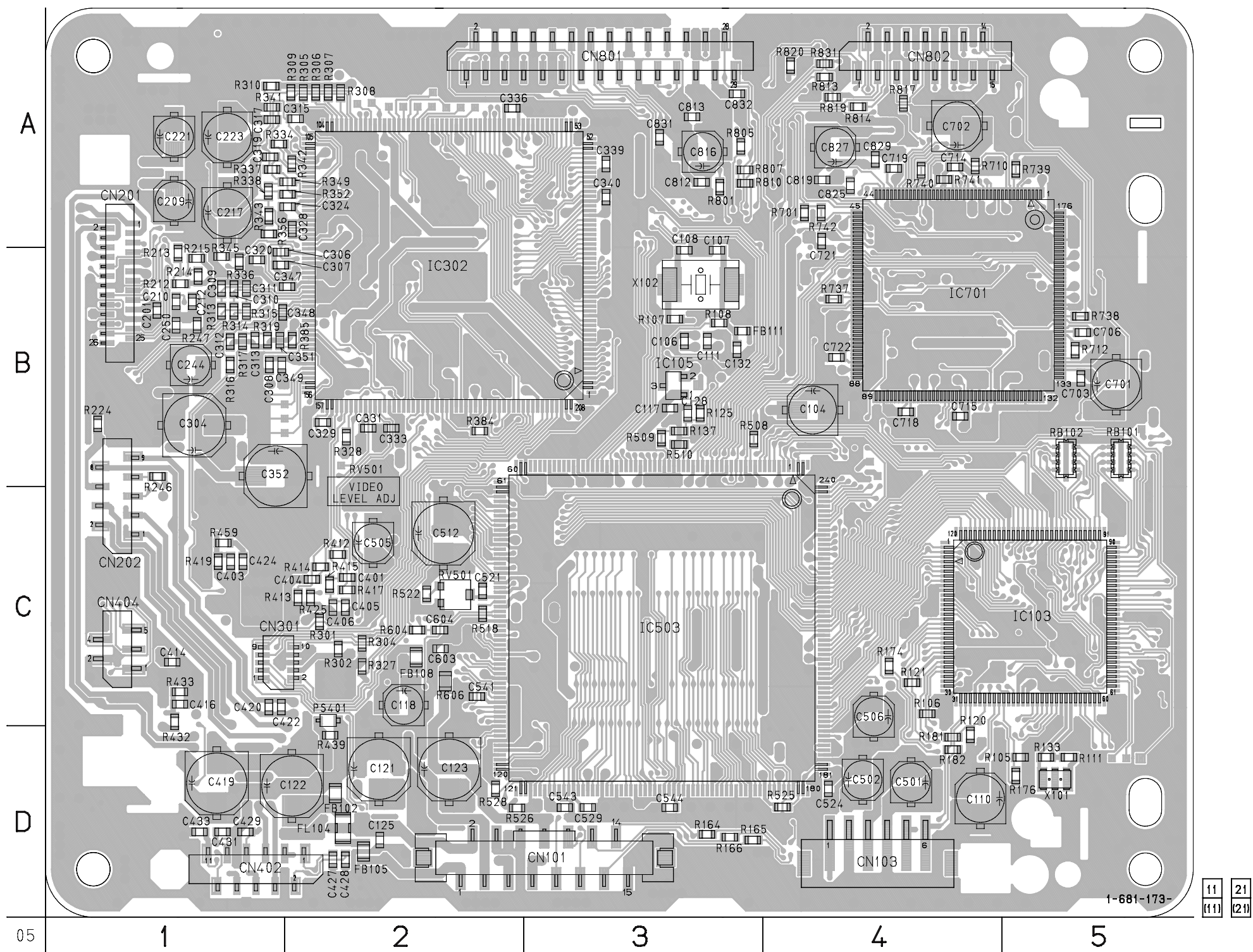

- Power Block (TOP-244U)
(US, Canadian, Mexican)
- Power Block (HS13S0U)
(US, Canadian, Mexican, Taiwan)
- Power Block (HS13S0E)
(AEP, UK, Russian, 220-240V AC Area in E, Saudi Arabia, Middle East, Argentina, Hong Kong, Korea, Singapore, Australian)
- Power Block (HS13S0F)
(110-240V AC Area in E, Brazilian, PX)
- (SWITCHING REGULATOR)

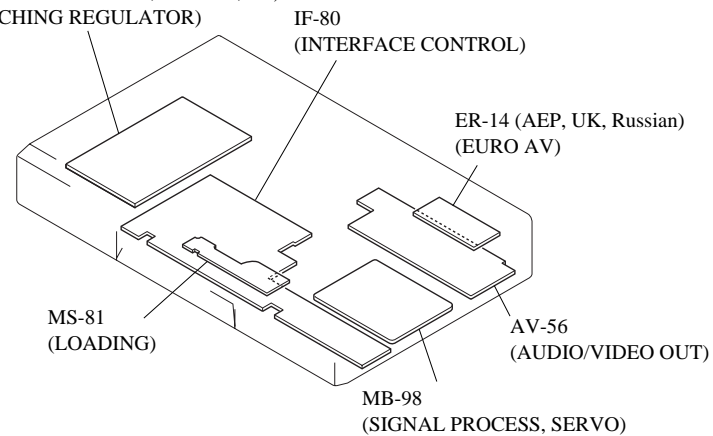

MB-98 BOARD(SIDE B)

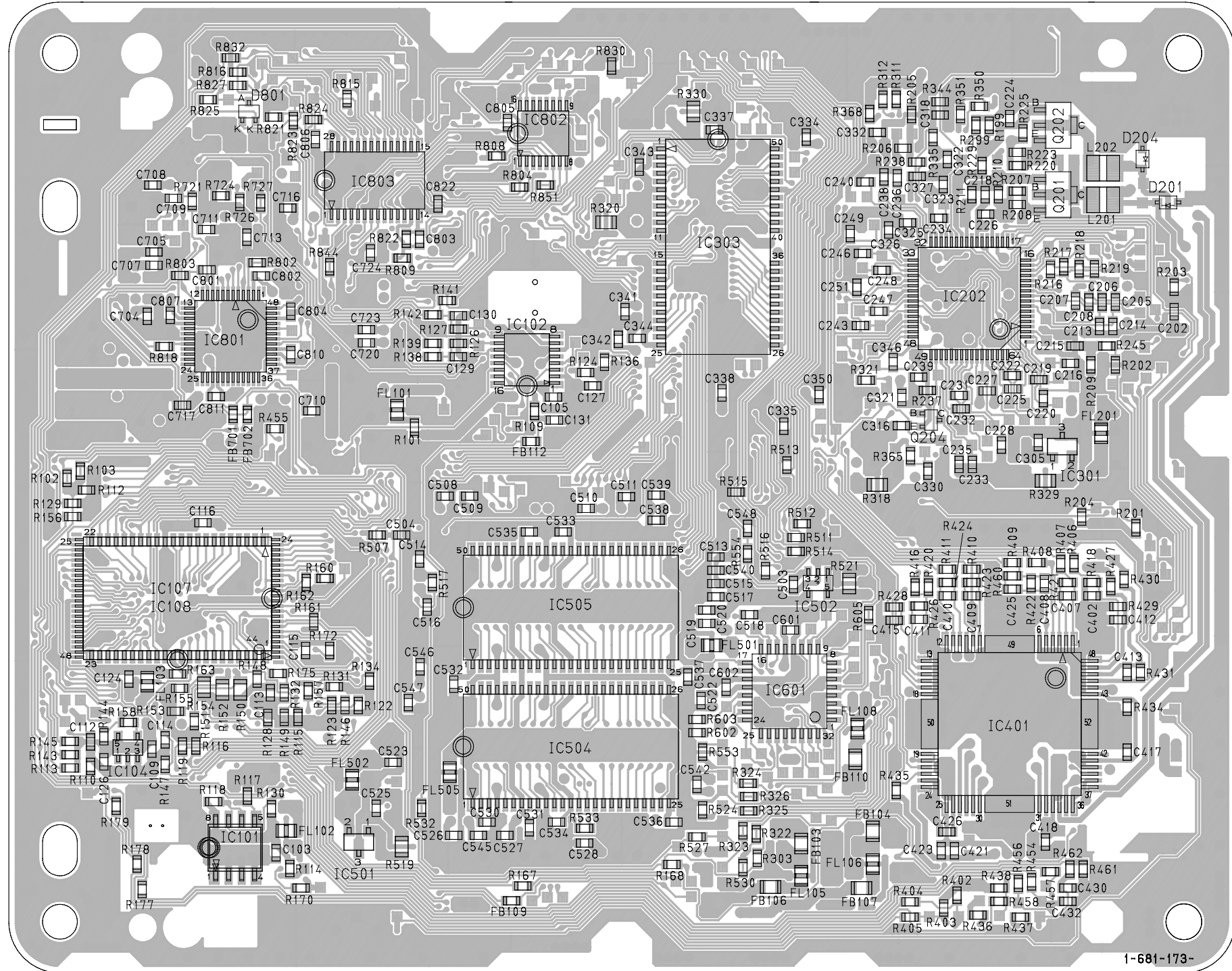

MB-98 BOARD (SIDE B)

- IC101 D-4
- IC102 B-3
- IC107 C-5
- IC202 B-2
- IC301 B-1
- IC303 A-3
- IC401 C-1
- IC501 D-4
- IC502 C-2
- IC504 C-3
- IC505 C-3
- IC601 C-2
- IC801 B-4
- IC802 A-3
- Q201 A-1

A

B

C

D

11	21
(11)	(21)

1-681-173-

05 5 4 3 2 1

MB-98 (RF AMP, SERVO) SCHEMATIC DIAGRAM • See page 4-7 for printed wiring board.

– Ref. No.: MB-98 board; 2,000 series –

The components identified by mark Δ or dotted line with mark Δ are critical for safety. Replace only with part number specified.

Les composants identifiés par une marque Δ sont critiques pour la sécurité. Ne les remplacer que par une pièce portant le numéro spécifié.

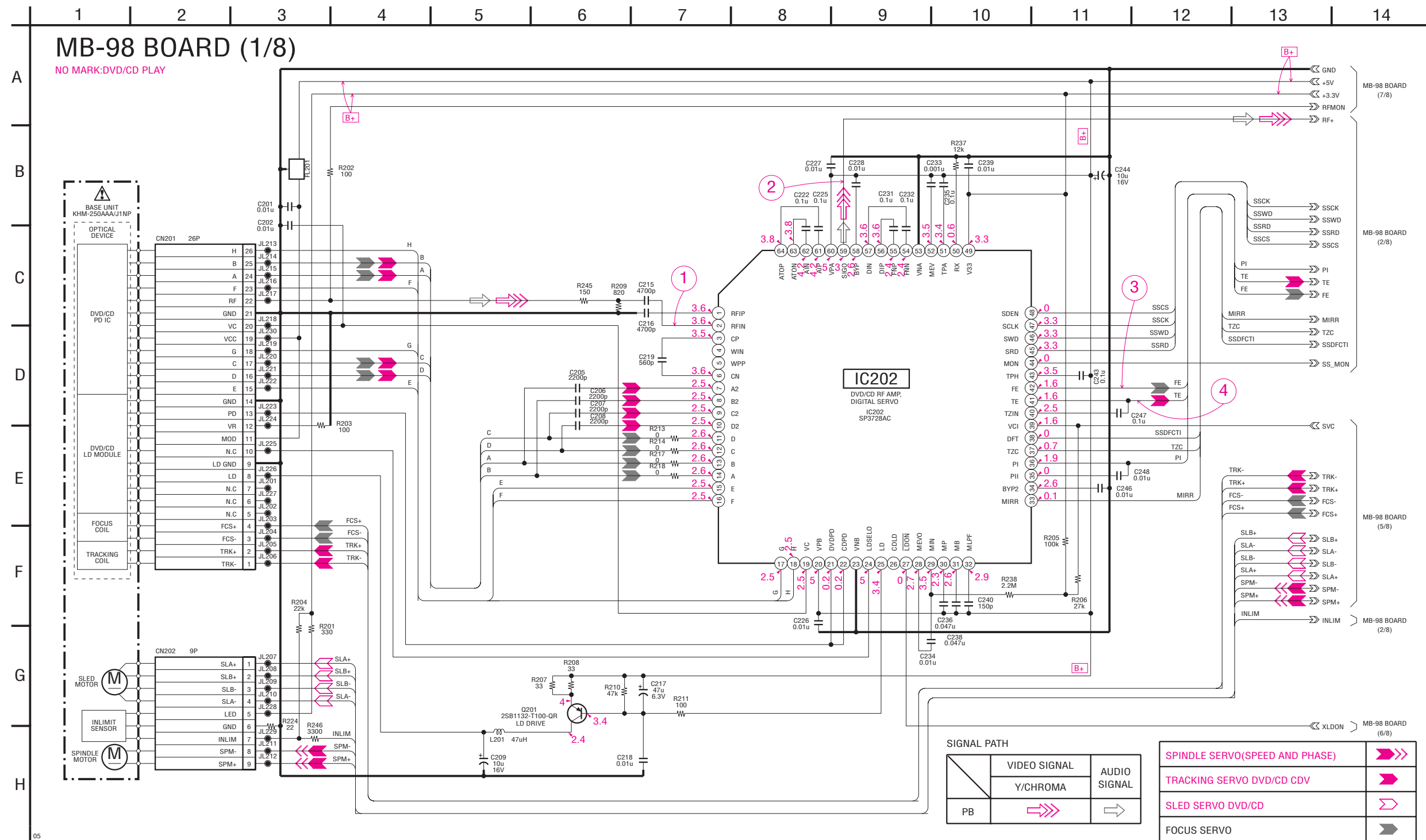

• Waveforms

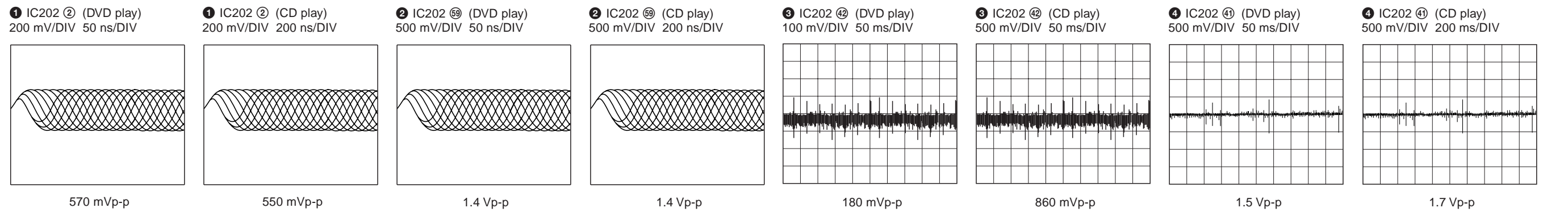

MB-98 (ARP, SERVO DSP) SCHEMATIC DIAGRAM • See page 4-7 for printed wiring board.

- Ref. No.: MB-98 board; 2,000 series -

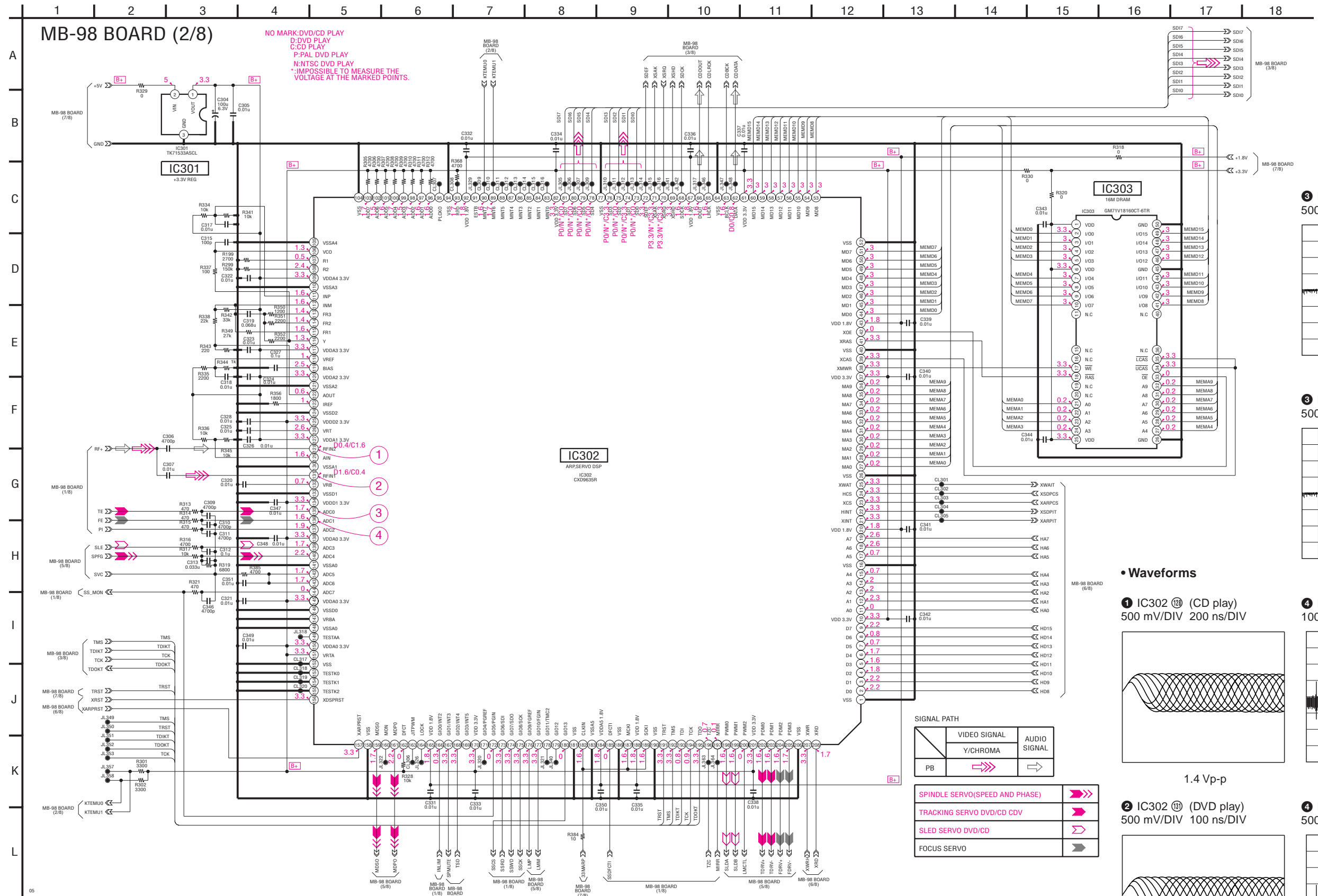

③ IC302 (15) (DVD play) 500 mV/DIV 50 ms/DIV

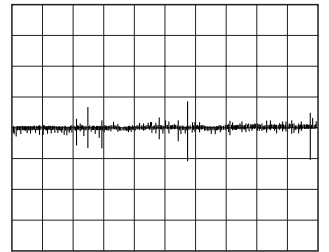

1.4 Vp-p

③ IC302 (15) (CD play) 500 mV/DIV 200 ms/DIV

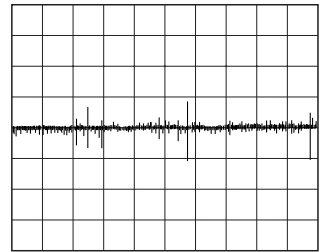

1.7 Vp-p

• Waveforms

① IC302 (12) (CD play) 500 mV/DIV 200 ns/DIV

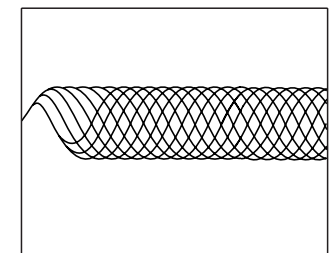

1.4 Vp-p

④ IC302 (13) (DVD play) 100 mV/DIV 50 ms/DIV

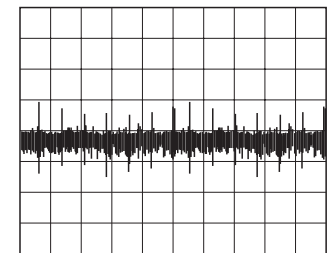

160 mVp-p

② IC302 (11) (DVD play) 500 mV/DIV 100 ns/DIV

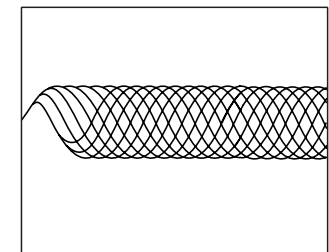

1.4 Vp-p

④ IC302 (13) (CD play) 500 mV/DIV 50 ms/DIV

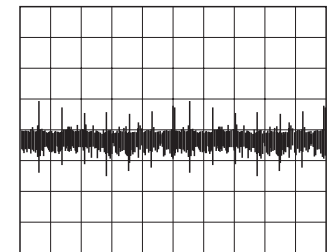

860 mVp-p

SIGNAL PATH	
VIDEO SIGNAL	AUDIO SIGNAL
Y/CHROMA	
PB	
SPINDLE SERVO(SPEED AND PHASE)	
TRACKING SERVO DVD/CD CDV	
SLED SERVO DVD/CD	
FOCUS SERVO	

MB-98 (AV DECODER) SCHEMATIC DIAGRAM • See page 4-7 for printed wiring board.

– Ref. No.: MB-98 board; 2,000 series –

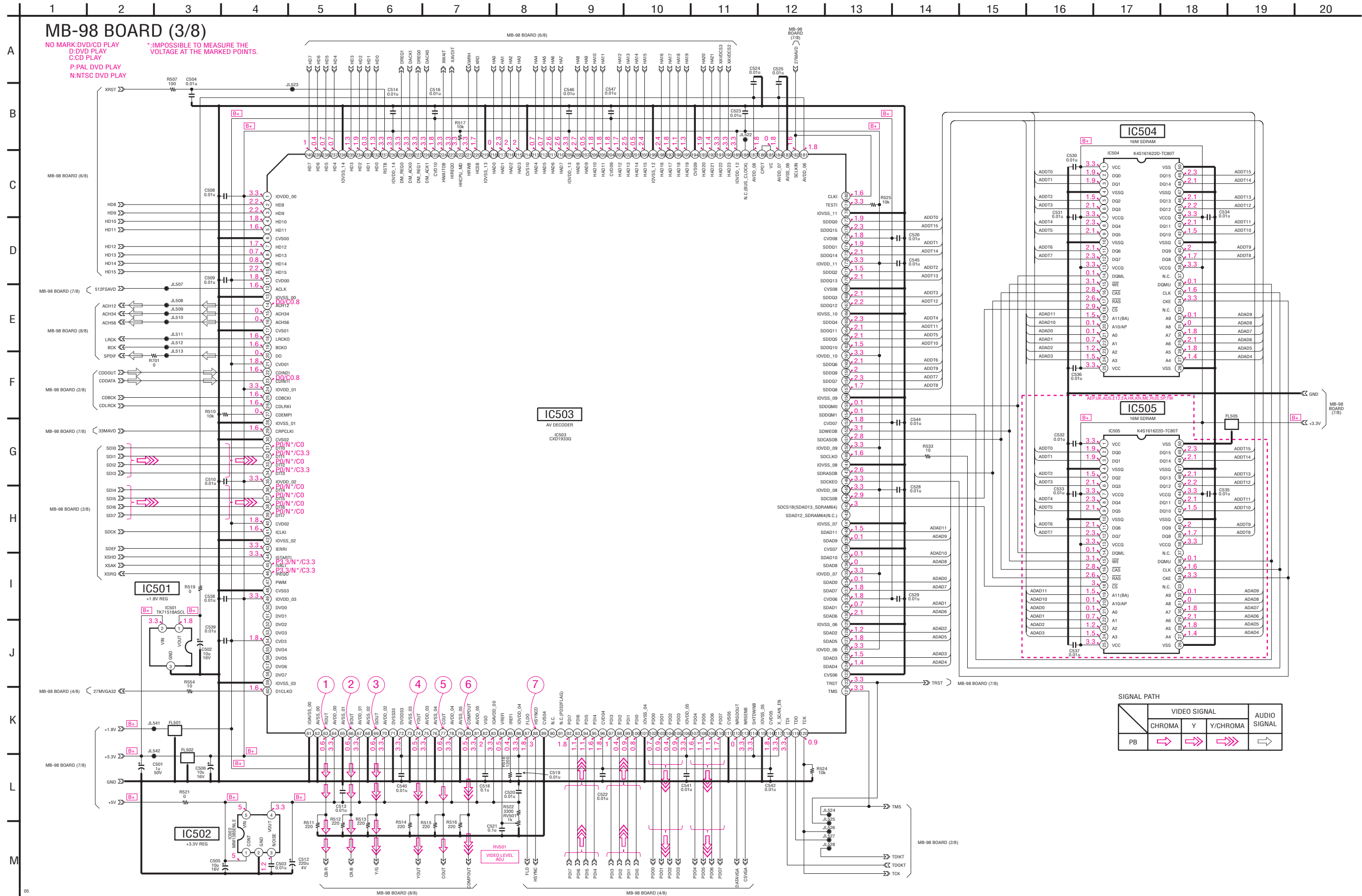

MB-98 (BNR) SCHEMATIC DIAGRAM • See page 4-7 for printed wiring board.
 – Ref. No.: MB-98 board; 2,000 series –

• Waveforms

① IC503 ③ : AEP, UK, RUS (LINE : RGB mode)

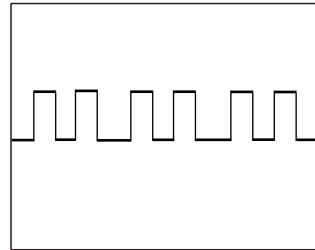

660 mVp-p (H)

③ IC503 ③ : EXCEPT AEP, UK, RUS

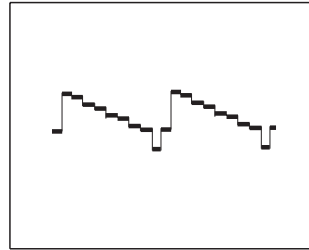

940 mVp-p (H)

① IC503 ③ : EXCEPT AEP, UK, RUS

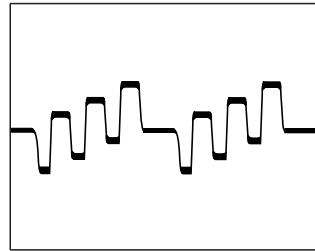

620 mVp-p (H)

④ IC503 ⑦

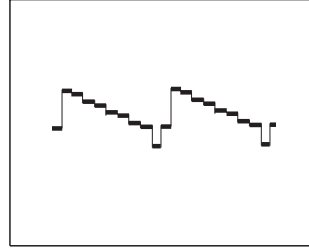

940 mVp-p (H)

② IC503 ⑥ : AEP, UK, RUS (LINE : RGB mode)

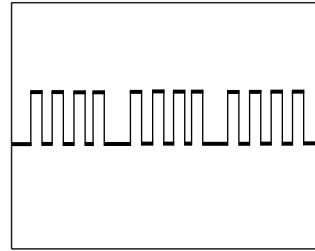

660 mVp-p (H)

⑤ IC503 ⑦

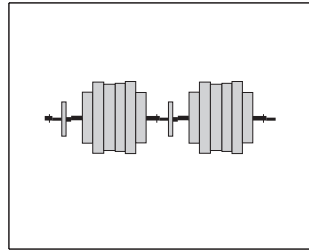

810 mVp-p (H)

② IC503 ⑥ : EXCEPT AEP, UK, RUS

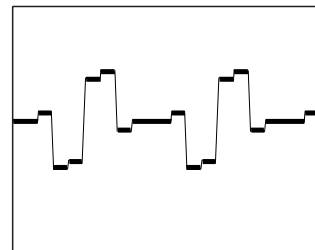

620 mVp-p (H)

⑥ IC503 ⑧

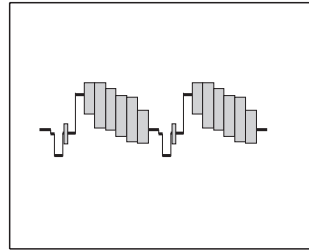

1.1 Vp-p (H)

③ IC503 ③ : AEP, UK, RUS (LINE : RGB mode)

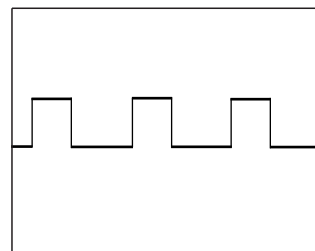

660 mVp-p (H)

⑦ IC503 ⑧

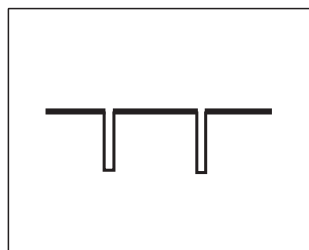

3.2 Vp-p (H)

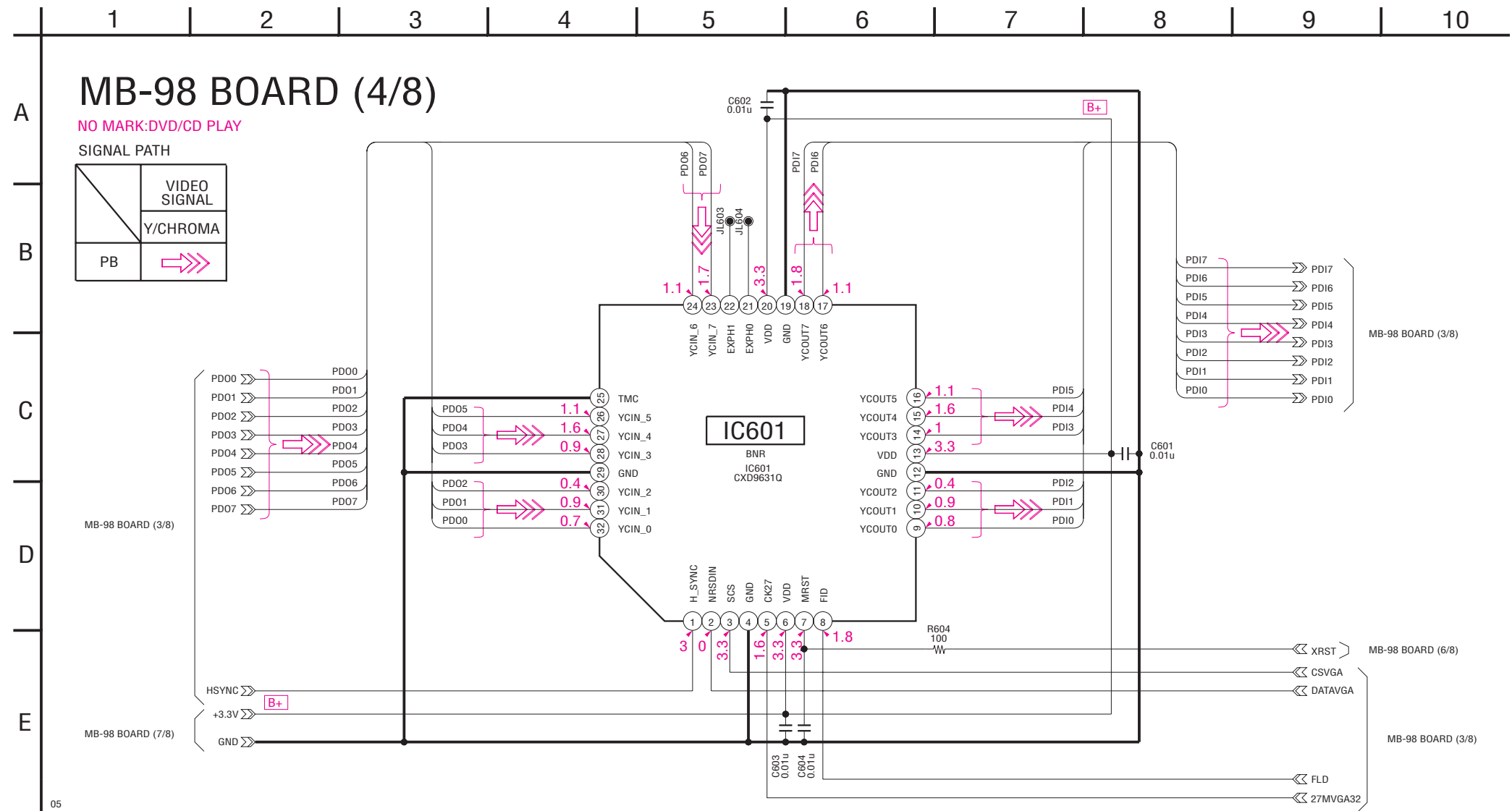

MB-98 (DRIVE) SCHEMATIC DIAGRAM • See page 4-7 for printed wiring board.

– Ref. No.: MB-98 board; 2,000 series –

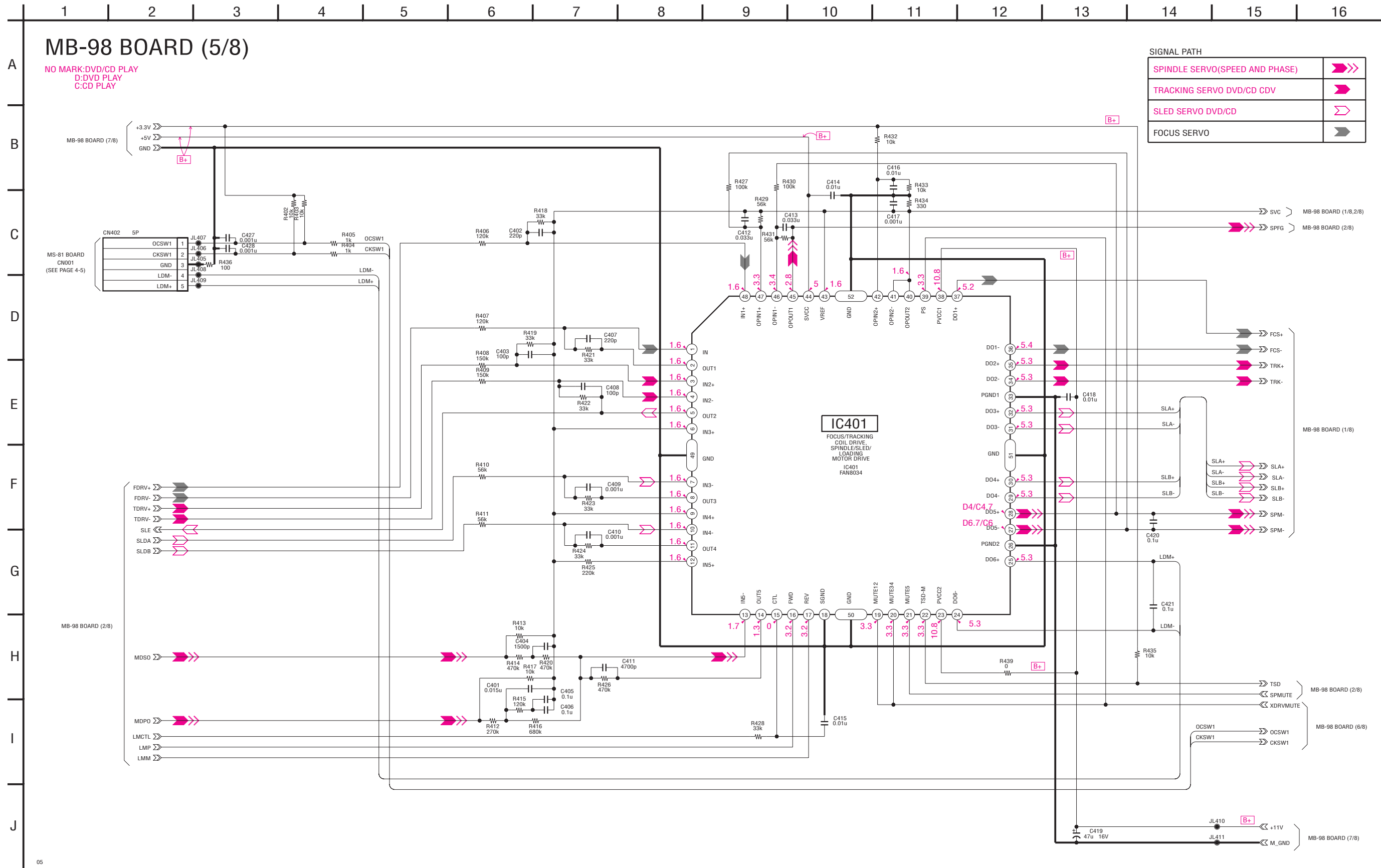

*1: Either IC107 or IC108 is used.

MB-98 (SYSTEM CONTROL) SCHEMATIC DIAGRAM • See page 4-7 for printed wiring board.
- Ref. No.: MB-98 board; 2,000 series -

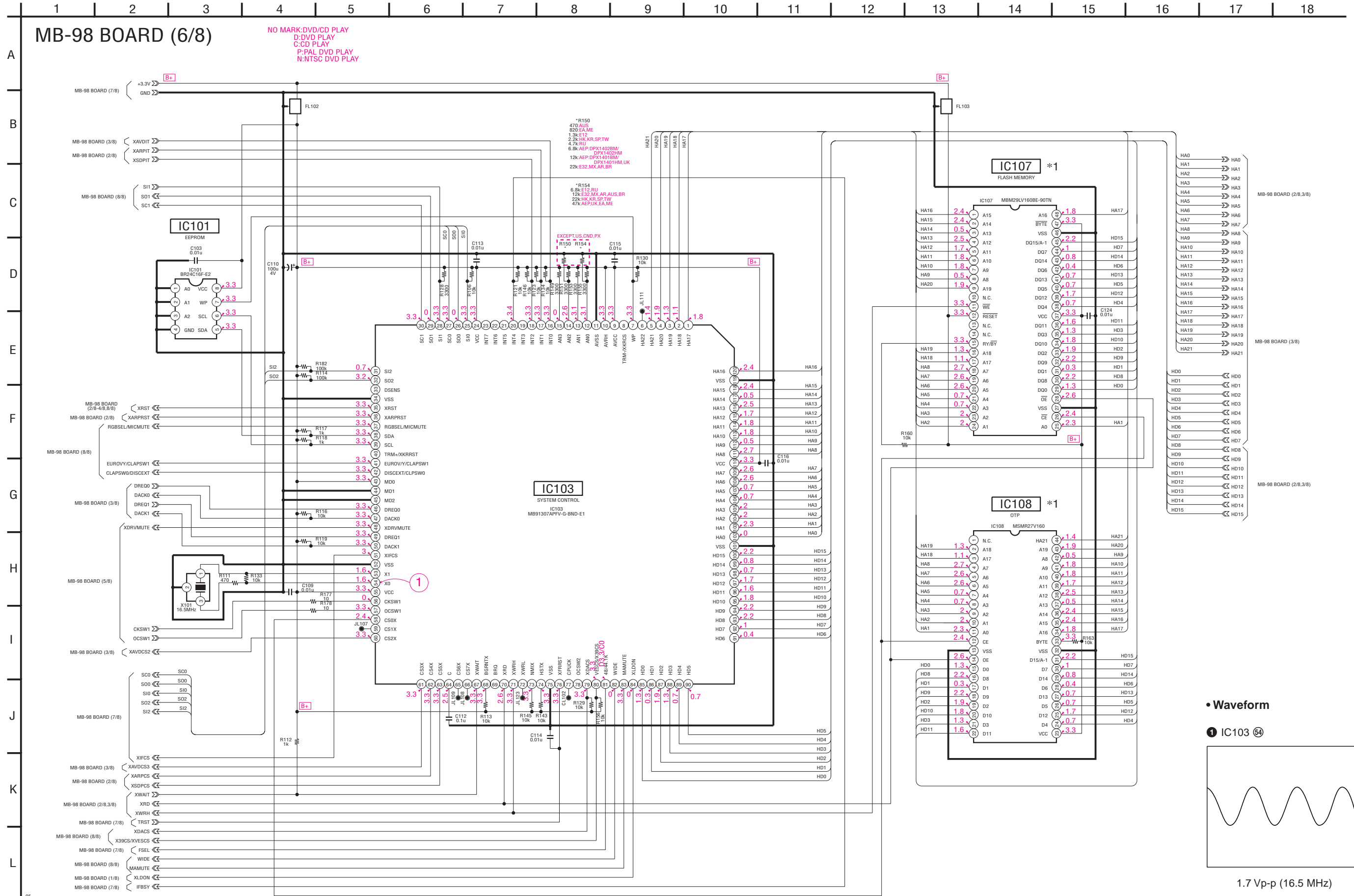

MB-98 (CLOCK GENERATOR) SCHEMATIC DIAGRAM • See page 4-7 for printed wiring board.
 – Ref. No.: MB-98 board; 2,000 series –

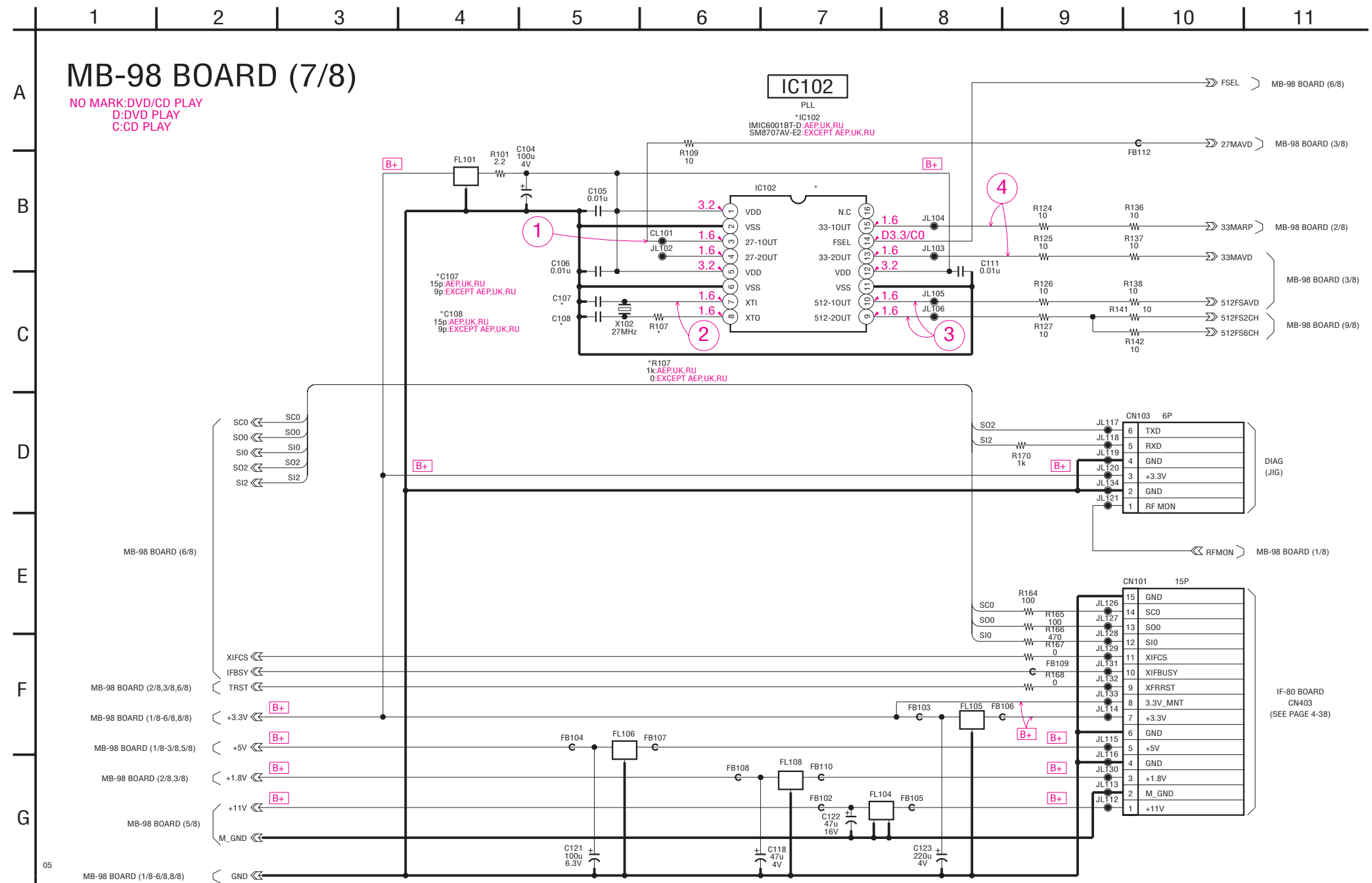

• Waveforms

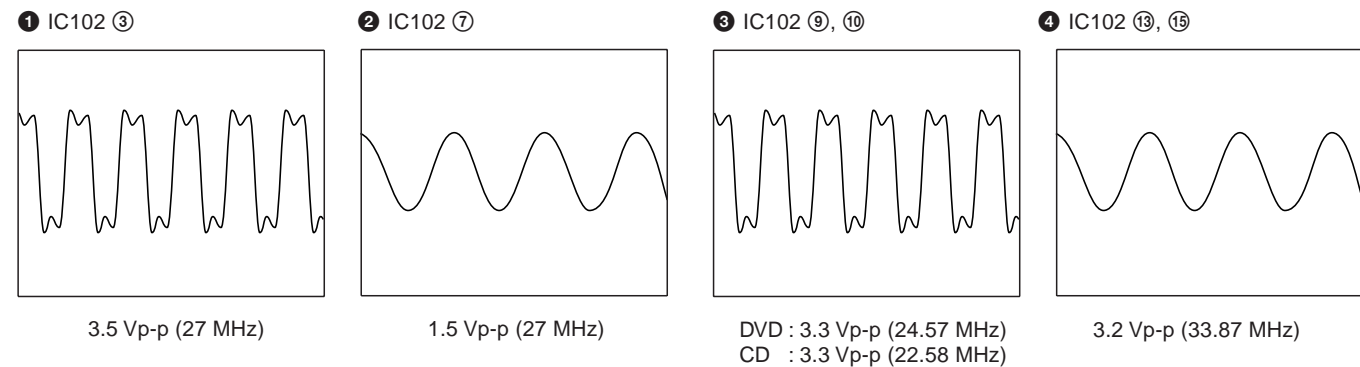

MB-98 (AUDIO DSP, D/A CONVERTER) SCHEMATIC DIAGRAM • See page 4-7 for printed wiring board.
 – Ref. No.: MB-98 board; 2,000 series –

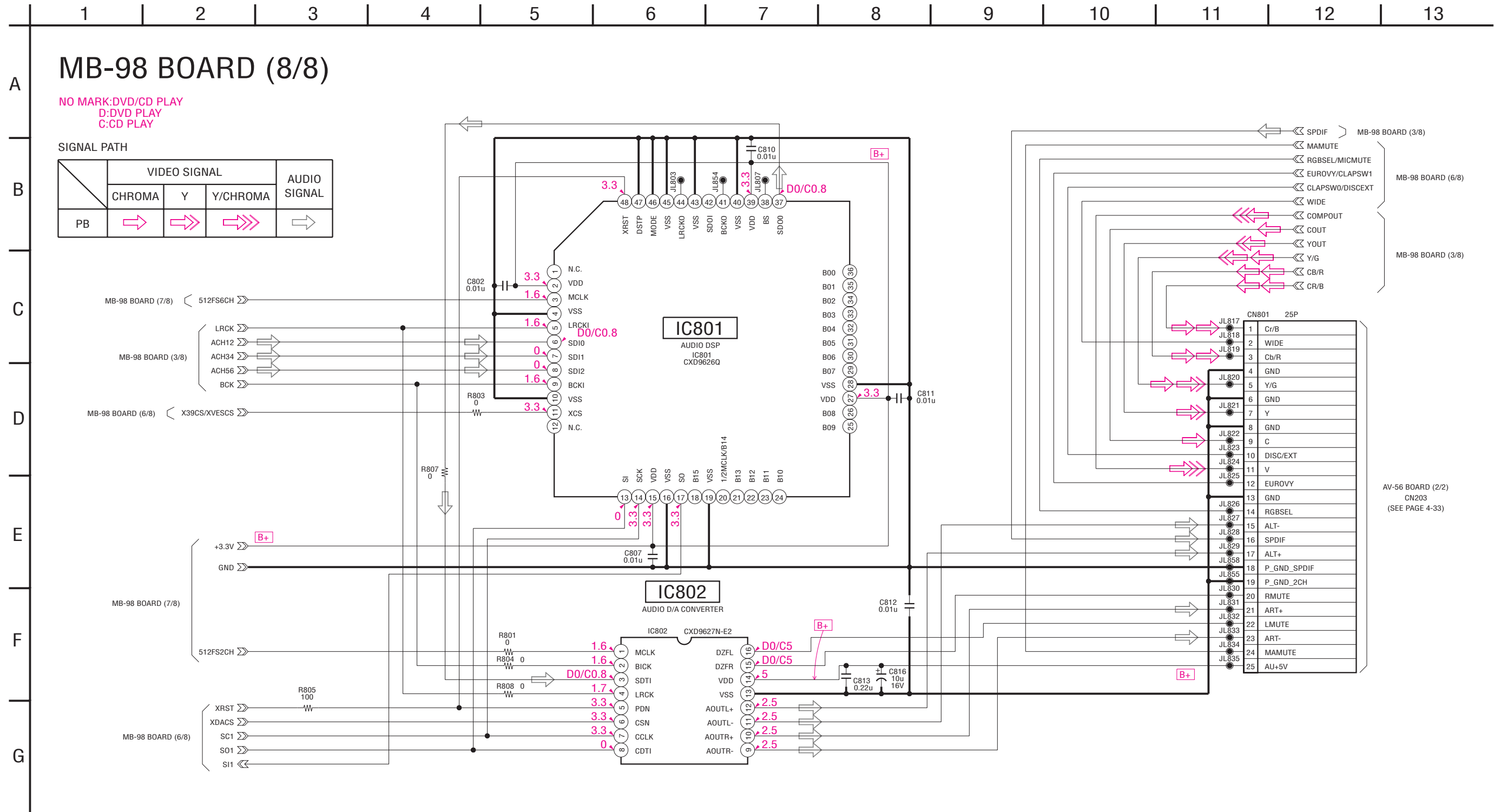

• Waveforms

① IC102 ㉑ : AEP, UK, RUS
IC102 ㉓ : EXCEPT AEP, UK, RUS

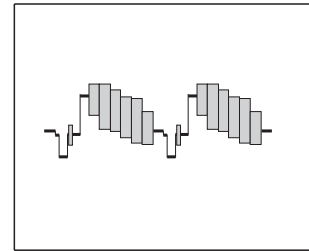

2.4 Vp-p (H)

④ IC102 ㉔ : EXCEPT AEP, UK, RUS

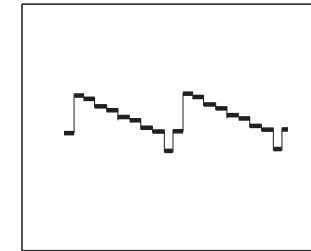

2.0 Vp-p (H)

② IC102 ㉒ : AEP, UK, RUS
IC102 ㉑ : EXCEPT AEP, UK, RUS

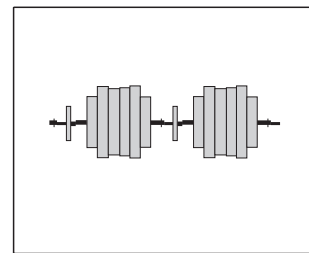

1.8 Vp-p (H)

⑤ IC102 ㉚ : EXCEPT AEP, UK, RUS

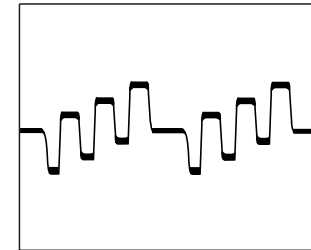

1.3 Vp-p (H)

③ IC102 ㉗ : AEP, UK, RUS
IC102 ㉔ : EXCEPT AEP, UK, RUS

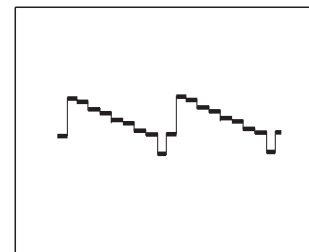

2.0 Vp-p (H)

⑥ IC102 ㉘ : EXCEPT AEP, UK, RUS

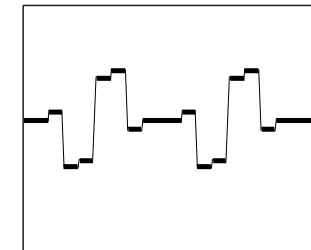

1.3 Vp-p (H)

AV-56 BOARD

CN102	C-5
CN202	B-5
CN203	C-3
D004	A-6
D005	A-5
D201	B-2
D202	C-1
D203	B-1
D205	B-6
IC101	A-7
IC102	B-5
IC201	B-3
IC203	B-2
Q104	B-6
Q105	B-6
Q106	C-4
Q201	C-6
Q202	B-1
Q203	C-6
Q204	B-1
Q205	B-1
Q206	B-1
Q207	A-3
Q208	A-4
Q209	B-1
Q210	B-1
Q211	A-2
Q216	B-6

Power Block (TOP-244U)
(US, Canadian, Mexican)
Power Block (HS13S0U)
(US, Canadian, Mexican, Taiwan)
Power Block (HS13S0E)
(AEP, UK, Russian, 220-240V AC Area in E, Saudi Arabia, Middle East,
Argentina, Hong Kong, Korea, Singapore, Australian)
Power Block (HS13S0F)
(110-240V AC Area in E, Brazilian, PX)
(SWITCHING REGULATOR)

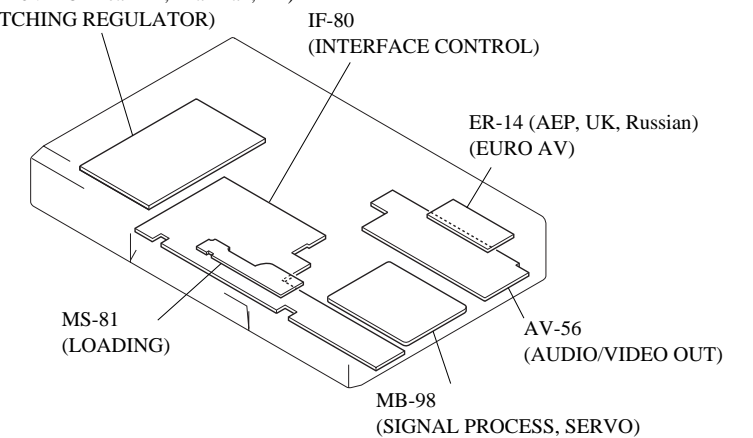

There are a few cases that the part isn't mounted in this model is printed on this diagram.

AV-56 (AUDIO/VIDEO OUT) PRINTED WIRING BOARD
- Ref. No.: AV-56 board; 1,000 series -

AV-56 BOARD

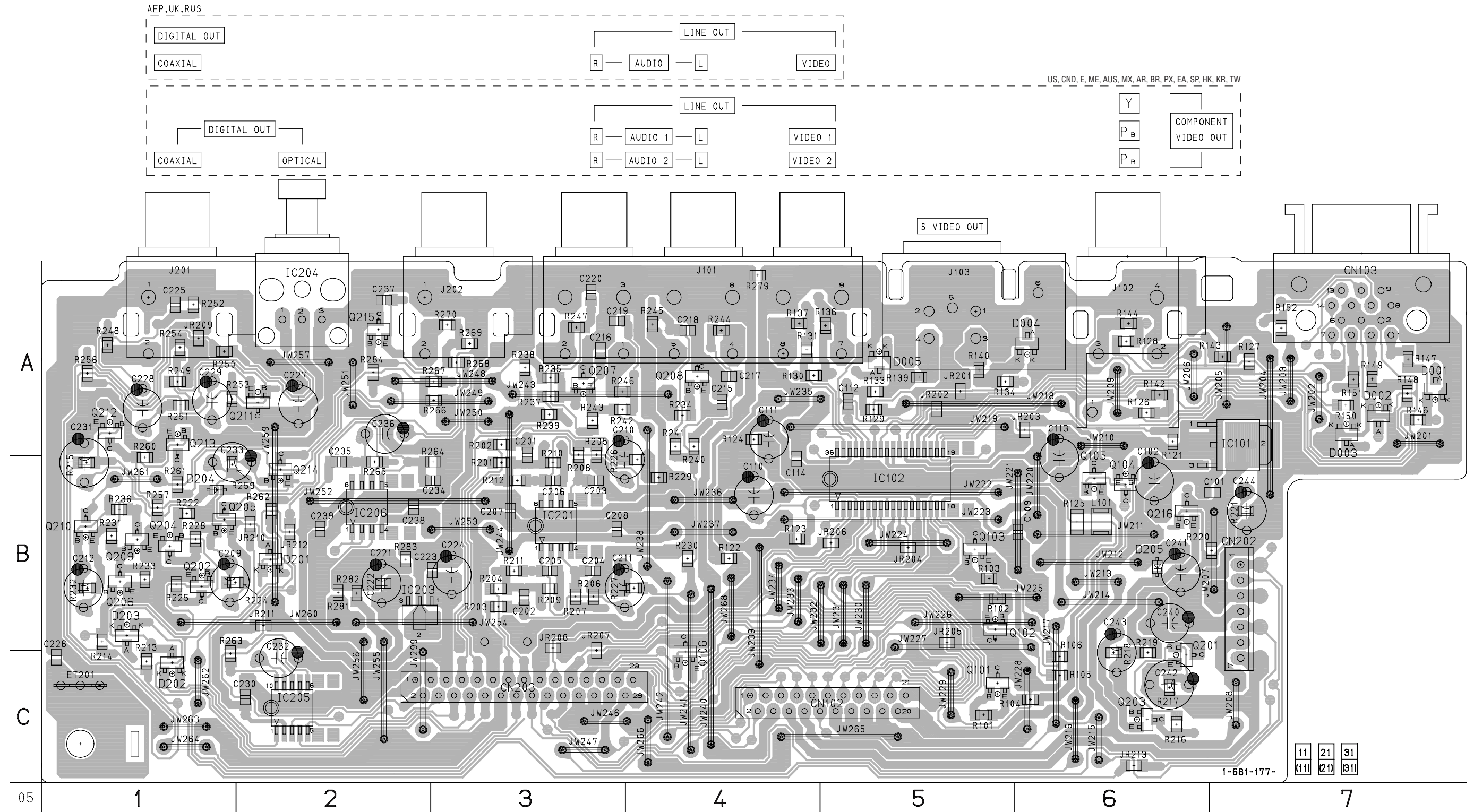

AV-56 (VIDEO BUFFER) SCHEMATIC DIAGRAM • See page 4-29 for printed wiring board, and see page 4-28 for waveforms.

– Ref. No.: AV-56 board; 1,000 series –

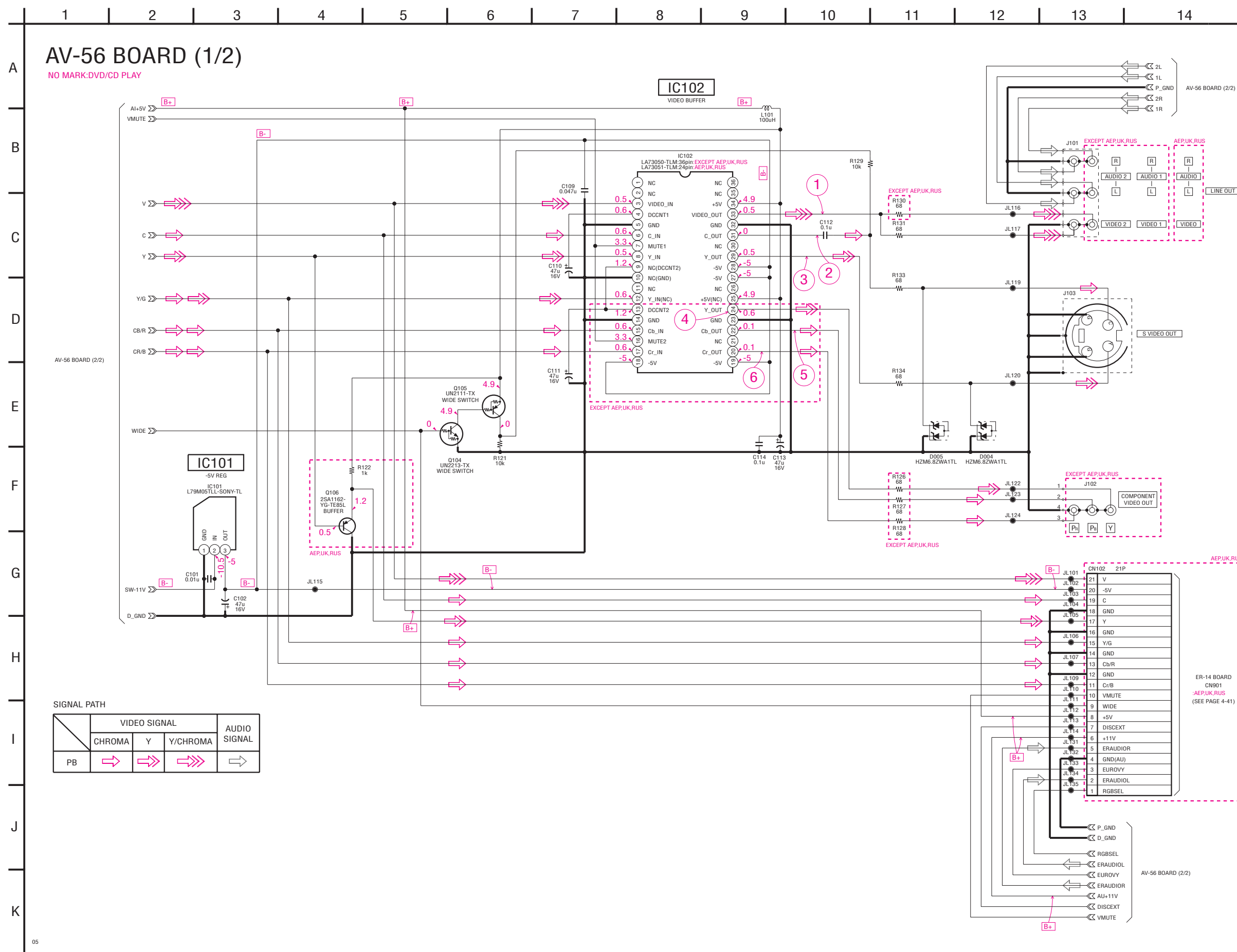

AV-56 (AUDIO AMP) SCHEMATIC DIAGRAM • See page 4-29 for printed wiring board.
 – Ref. No.: AV-56 board; 1,000 series –

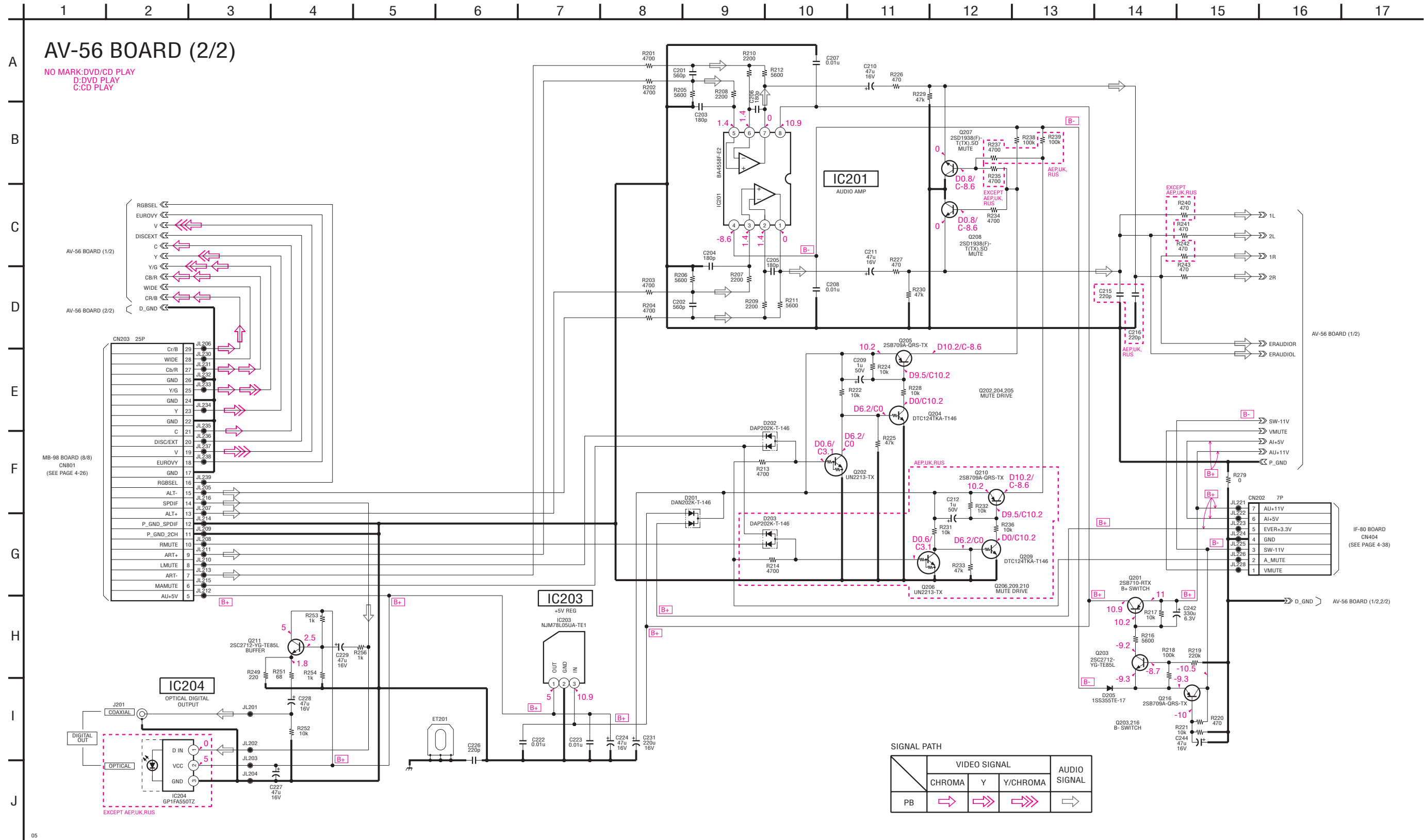

IF-80 (INTERFACE CONTROL) PRINTED WIRING BOARD

- Ref. No.: IF-80 board; 1,000 series -

There are a few cases that the part isn't mounted in this model is printed on this diagram.

IF-80 BOARD

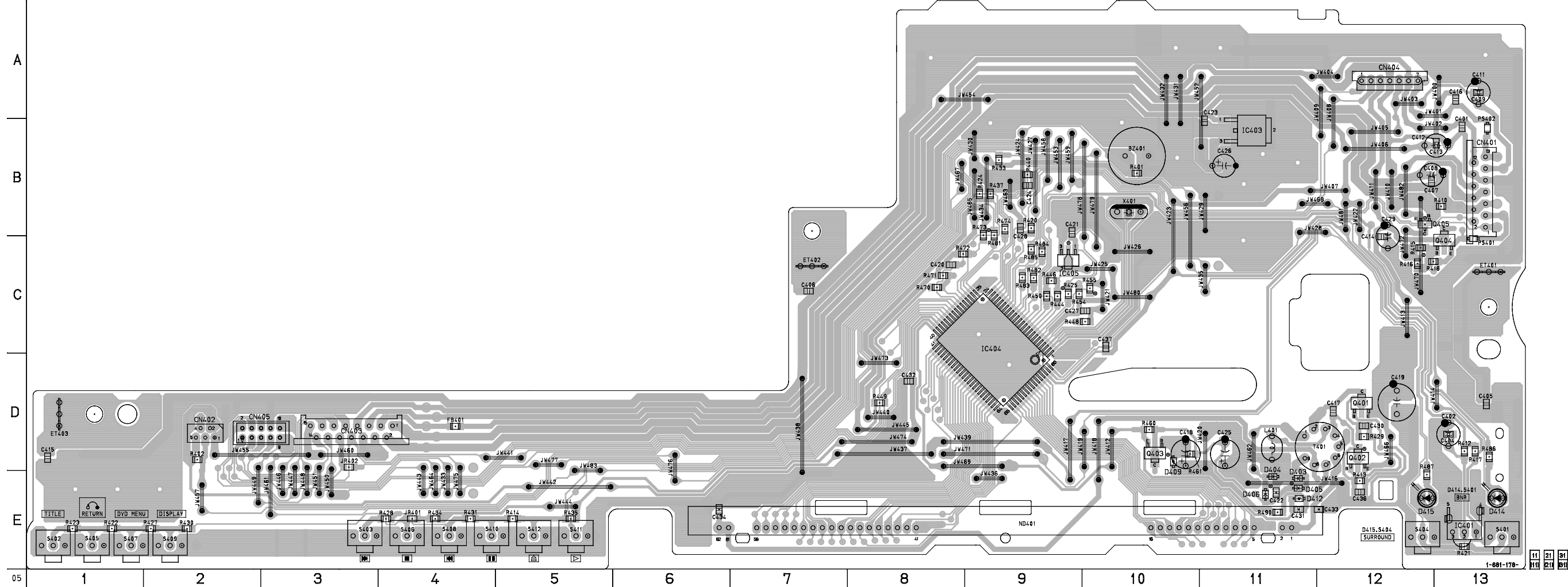

IF-80 BOARD

- CN401 B-13
- CN402 D-2
- CN403 D-3
- CN404 A-12
- CN405 D-2

- D403 E-11
- D404 E-11
- D405 E-11
- D406 E-11
- D412 E-11
- D414 E-13
- D415 E-12

- IC401 E-13
- IC403 B-11
- IC404 C-9
- IC405 C-9

- Q401 D-12
- Q402 D-12
- Q404 C-13
- Q405 B-13

- Power Block (TOP-244U)
(US, Canadian, Mexican)
- Power Block (HS13S0U)
(US, Canadian, Mexican, Taiwan)
- Power Block (HS13S0E)
(AEP, UK, Russian, 220-240V AC Area in E, Saudi Arabia, Middle East, Argentina, Hong Kong, Korea, Singapore, Australian)
- Power Block (HS13S0F)
(110-240V AC Area in E, Brazilian, PX)
- (SWITCHING REGULATOR)

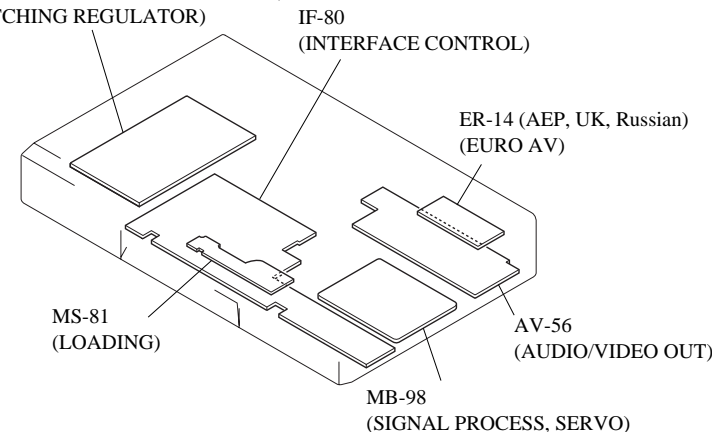

IF-80 (IF CON) SCHEMATIC DIAGRAM

– Ref. No.: IF-80 board; 1,000 series –

The components identified by mark \triangle or dotted line with mark \triangle are critical for safety. Replace only with part number specified.

Les composants identifiés par une marque \triangle sont critiques pour la sécurité. Ne les remplacer que par une pièce portant le numéro spécifié.

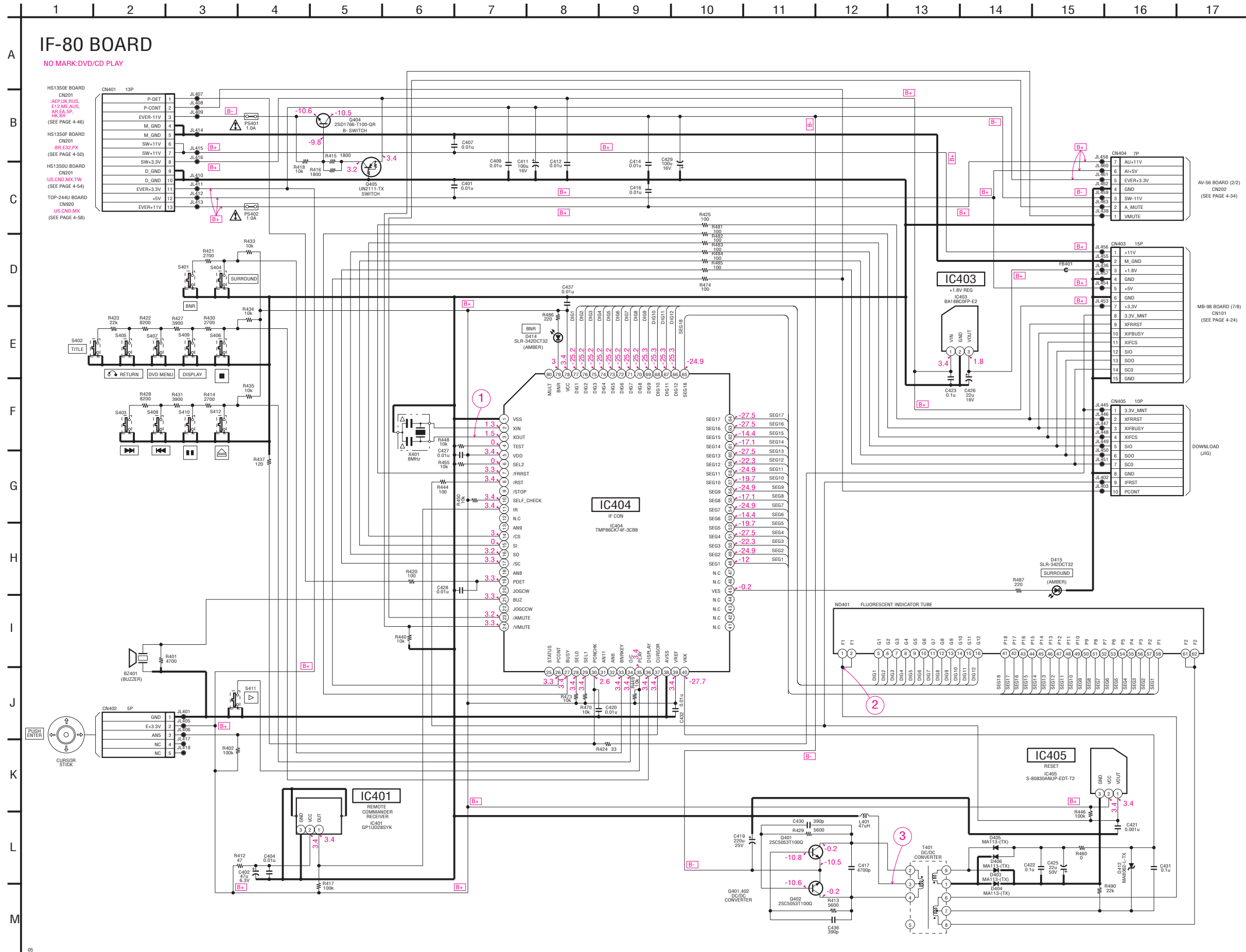

• Waveforms

① IC404 ③

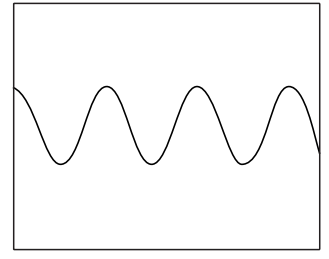

3.4 Vp-p (8 MHz)

② ND401 ①, ②

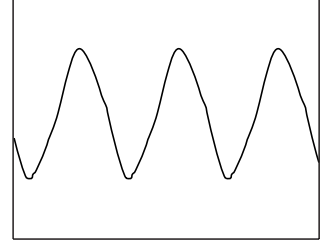

8 Vp-p (200 kHz)

③ T401 ③

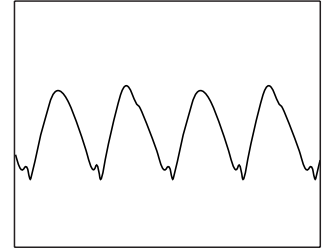

20 Vp-p (409 kHz)

DVP-NS300

ER-14 (EURO AV) PRINTED WIRING BOARD

- Ref. No.: ER-14 board; 1,000 series -
 - AEP, UK, RUS -

There are a few cases that the part isn't mounted in this model is printed on this diagram.

ER-14 BOARD

LINE 1 (RGB)-TV

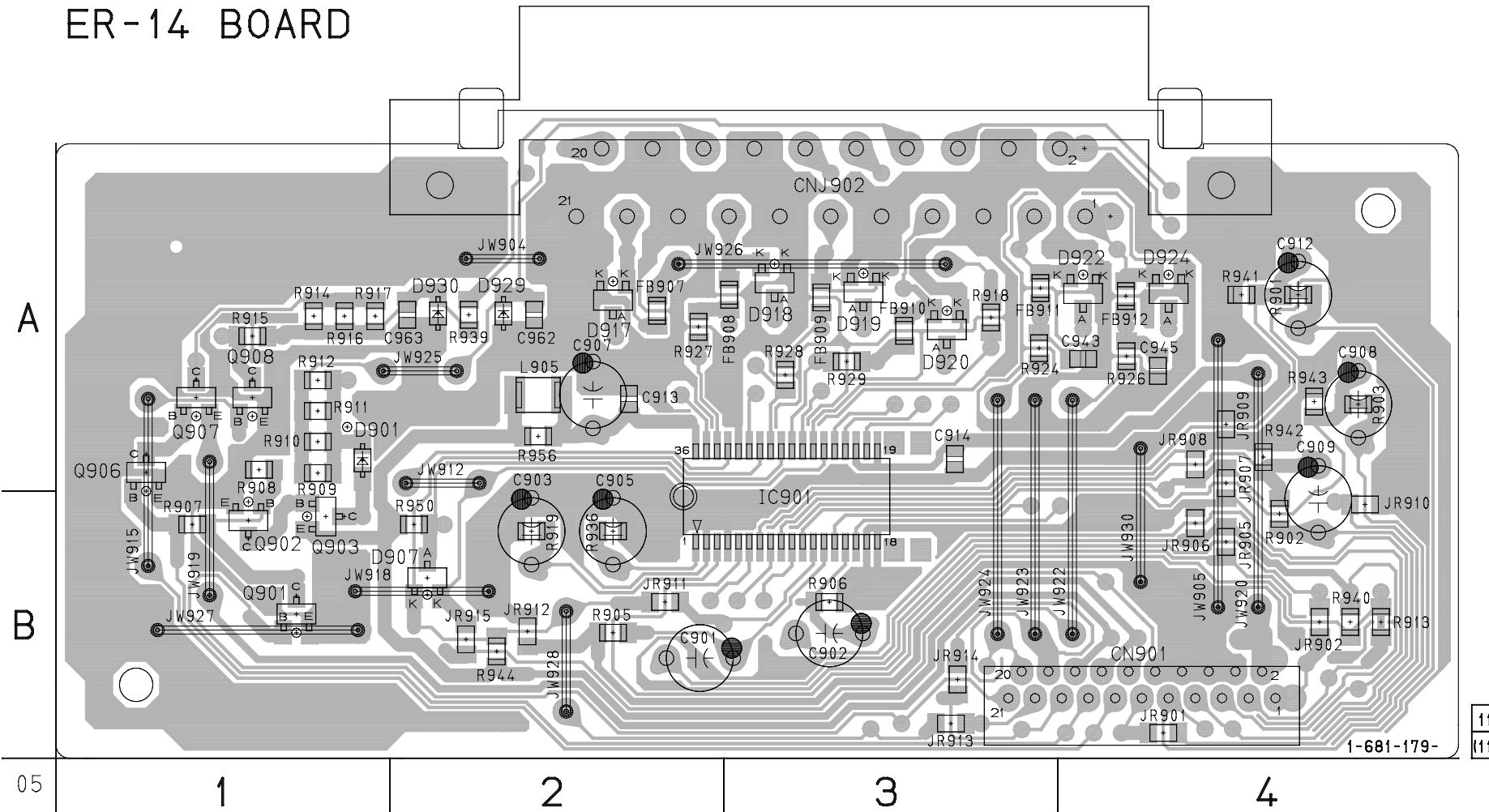

ER-14 BOARD

CN901	B-4
CN902	A-3
D901	A-1
D907	B-2
D917	A-2
D918	A-3
D919	A-3
D920	A-3
D929	A-2
D930	A-2
IC901	B-3
Q901	B-1
Q902	B-1
Q903	B-1
Q906	A-1
Q907	A-1
Q908	A-1

Power Block (TOP-244U)
 (US, Canadian, Mexican)
 Power Block (HS13S0U)
 (US, Canadian, Mexican, Taiwan)
 Power Block (HS13S0E)
 (AEP, UK, Russian, 220-240V AC Area in E, Saudi Arabia, Middle East,
 Argentina, Hong Kong, Korea, Singapore, Australian)
 Power Block (HS13S0F)
 (110-240V AC Area in E, Brazilian, PX)
 (SWITCHING REGULATOR)

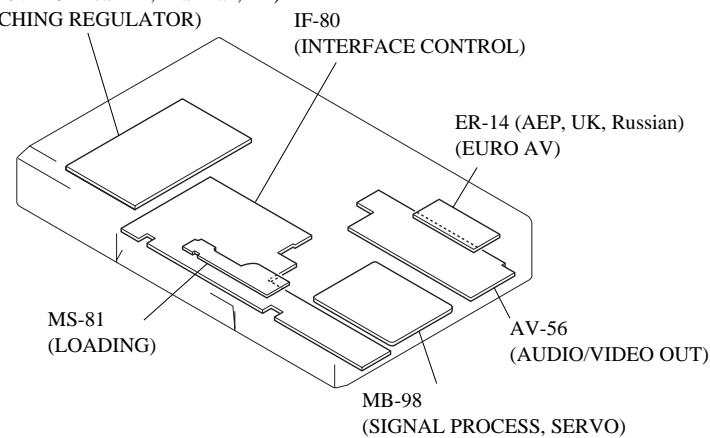

• Waveforms

① IC901 ⑳ (LINE : RGB mode)

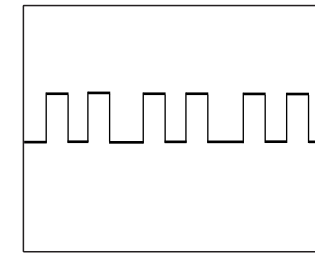

1.4 Vp-p (H)

④ IC901 ㉔ (LINE : S VIDEO mode)

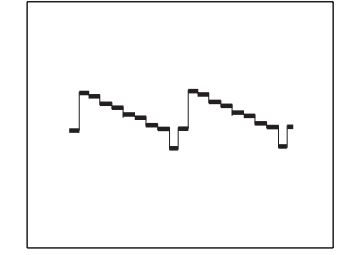

2.0 Vp-p (H)

① IC901 ㉑ (LINE : S VIDEO mode)

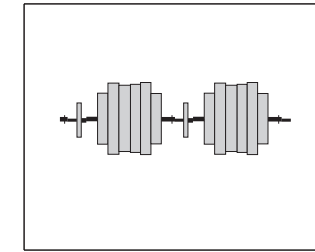

1.7 Vp-p (H)

② IC901 ㉒ (LINE : RGB mode)

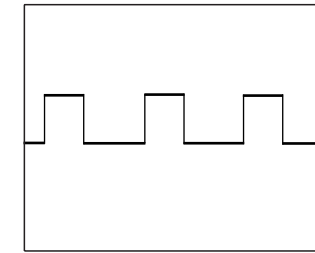

1.4 Vp-p (H)

③ IC901 ㉓ (LINE : RGB mode)

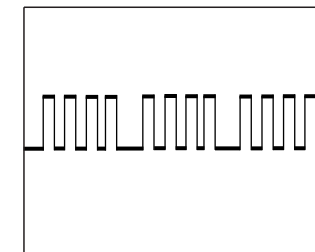

1.4 Vp-p (H)

④ IC901 ㉕

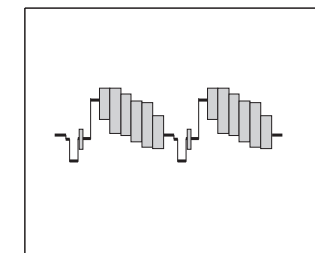

2.4 Vp-p (H)

ER-14 (EURO AV) SCHEMATIC DIAGRAM
 – Ref. No.: ER-14 board; 1,000 series –
 – AEP, UK, RUS –

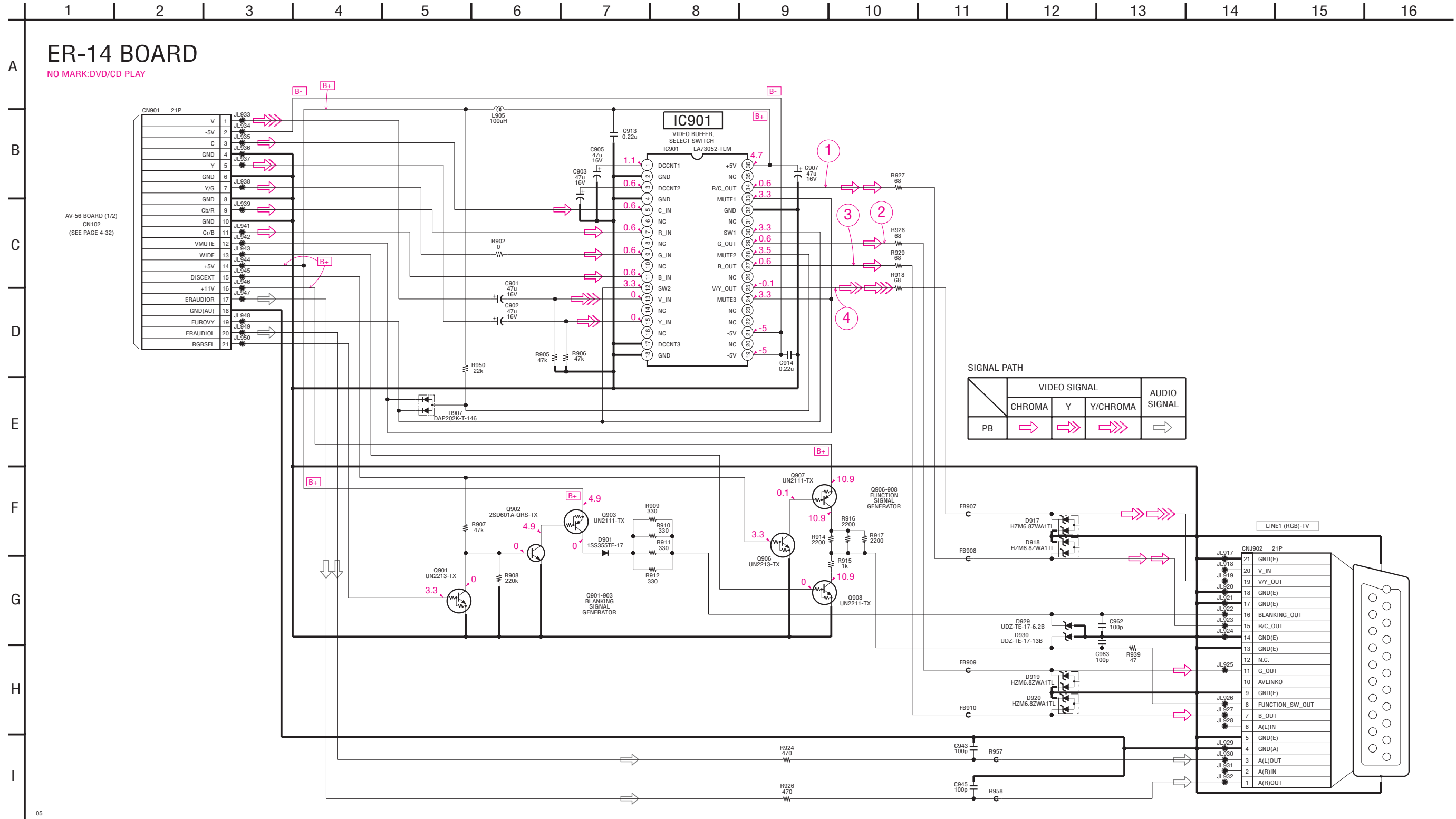

HS13S0E (SWITCHING REGULATOR) PRINTED WIRING BOARD

- Ref. No.: HS13S0E board; 3,000 series -
- AEP, UK, AR, AUS, E12, EA, HK, KR, ME, RUS, SP -

There are a few cases that the part isn't mounted in this model is printed on this diagram.

HS13S0E BOARD

HS13S0E BOARD

- CN101 B-3
- CN201 A-1
- D101 A-3
- D102 A-3
- D104 A-2
- D105 A-2
- D211 B-2
- D212 A-1
- D221 A-2
- D311 A-2
- D413 A-2
- D511 A-2
- D611 A-2
- D621 B-1
- IC301 B-2
- IC411 A-1
- Q101 A-3
- Q102 A-2
- Q211 B-1
- Q311 A-1
- Q411 A-2
- Q611 A-1
- Q621 B-1
- Q622 B-1
- Q712 A-1

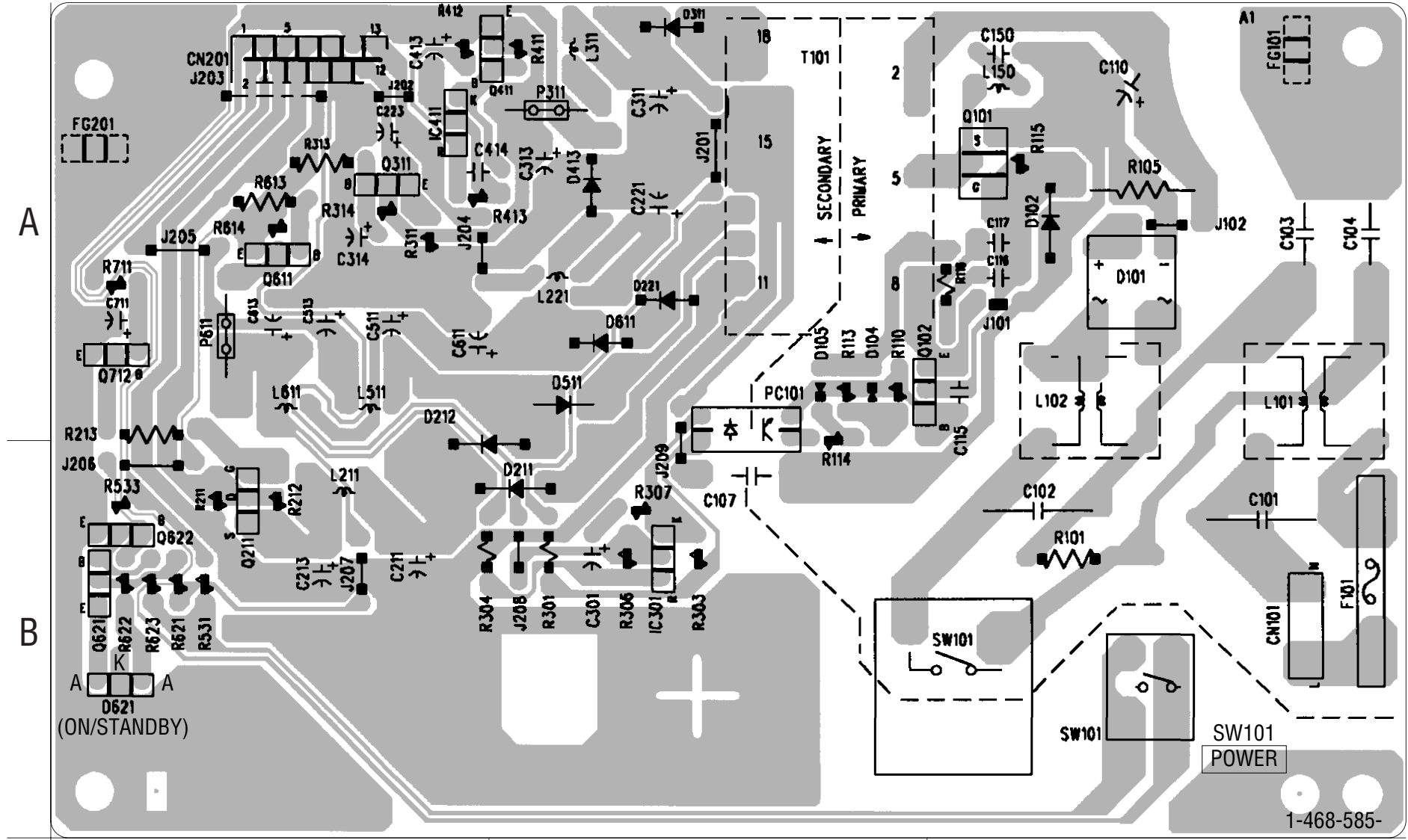

- Power Block (TOP-244U)
(US, Canadian, Mexican)
- Power Block (HS13S0U)
(US, Canadian, Mexican, Taiwan)
- Power Block (HS13S0E)
(AEP, UK, Russian, 220-240V AC Area in E, Saudi Arabia, Middle East, Argentina, Hong Kong, Korea, Singapore, Australian)
- Power Block (HS13S0F)
(110-240V AC Area in E, Brazilian, PX)
(SWITCHING REGULATOR)

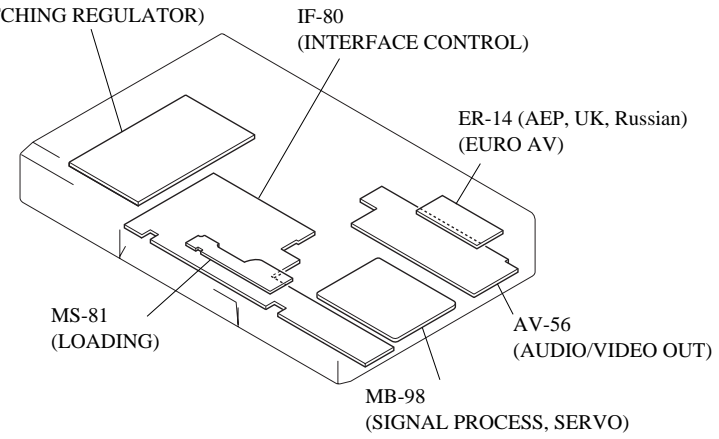

HS13S0E (SWITCHING REGULATOR) SCHEMATIC DIAGRAM

- Ref. No.: HS13S0E board; 3,000 series -
 - AEP, UK, AR, AUS, E12, EA, HK, KR, ME, RUS, SP -

The components identified by mark \triangle or dotted line with mark \triangle are critical for safety. Replace only with part number specified.

Les composants identifiés par une marque \triangle sont critiques pour la sécurité. Ne les remplacer que par une pièce portant le numéro spécifié.

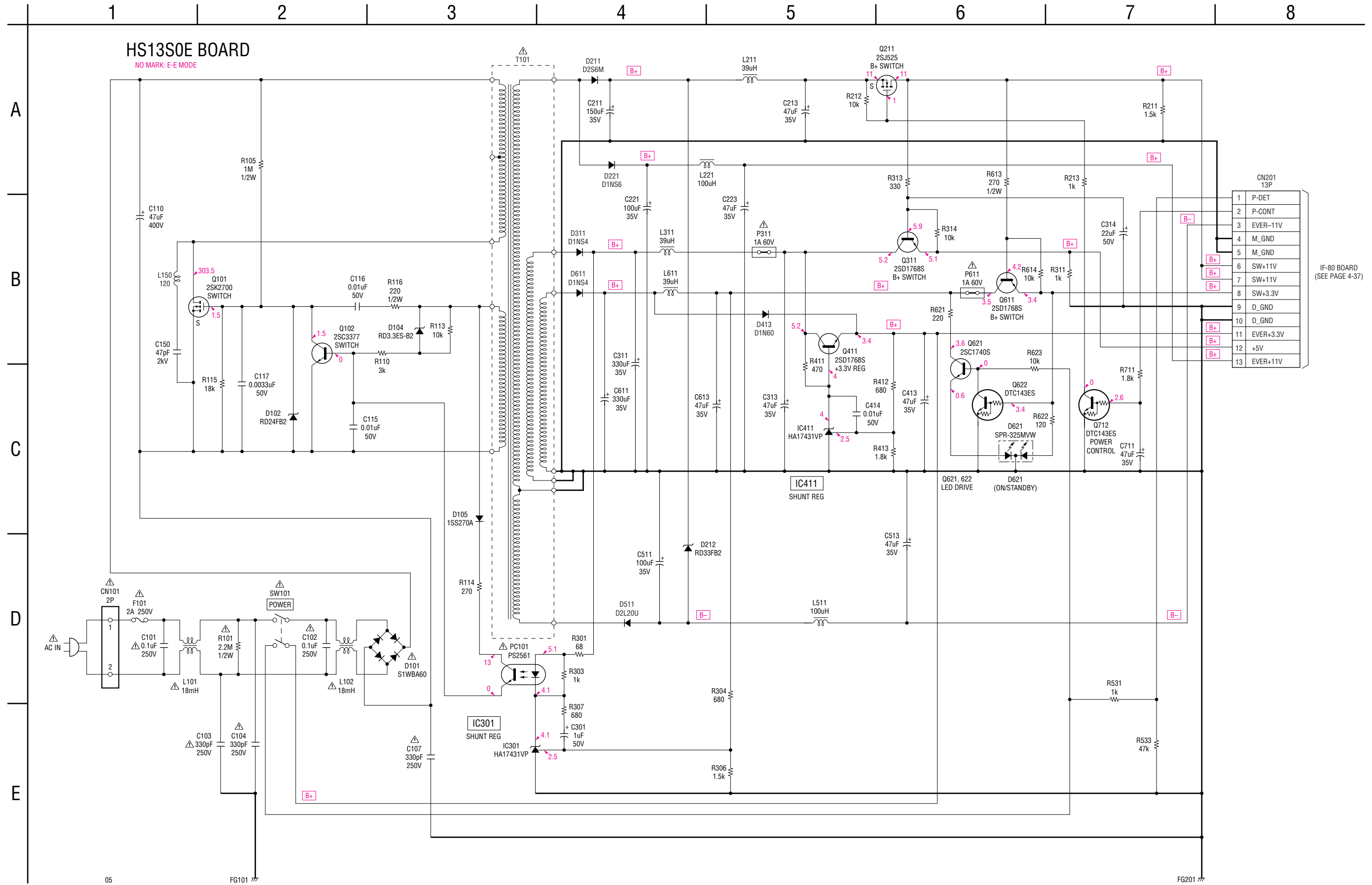

CN201 13P	
1	P-DET
2	P-CONT
3	EVER-11V
4	M_GND
5	M_GND
6	SW+11V
7	SW+11V
8	SW+3.3V
9	D_GND
10	D_GND
11	EVER+3.3V
12	+5V
13	EVER+11V

IF-80 BOARD (SEE PAGE 4-37)

HS13S0F (SWITCHING REGULATOR) PRINTED WIRING BOARD

- Ref. No.: HS13S0F board; 4,000 series -
 - BR, E32, PX -

There are a few cases that the part isn't mounted in this model is printed on this diagram.

HS13S0F BOARD

CN101	B-3
CN201	A-1
D101	A-3
D102	A-2
D104	A-2
D105	B-2
D131	B-2
D132	B-2
D135	A-2
D211	B-1
D212	B-1
D221	A-2
D311	A-1
D411	B-1
D511	A-1
D611	A-1
D615	B-1
IC131	B-2
IC401	B-1
IC701	B-1
Q101	A-2
Q102	A-2
Q103	A-2
Q131	B-3
Q311	A-1
Q621	B-1
Q622	B-1
Q712	B-1

HS13S0F BOARD

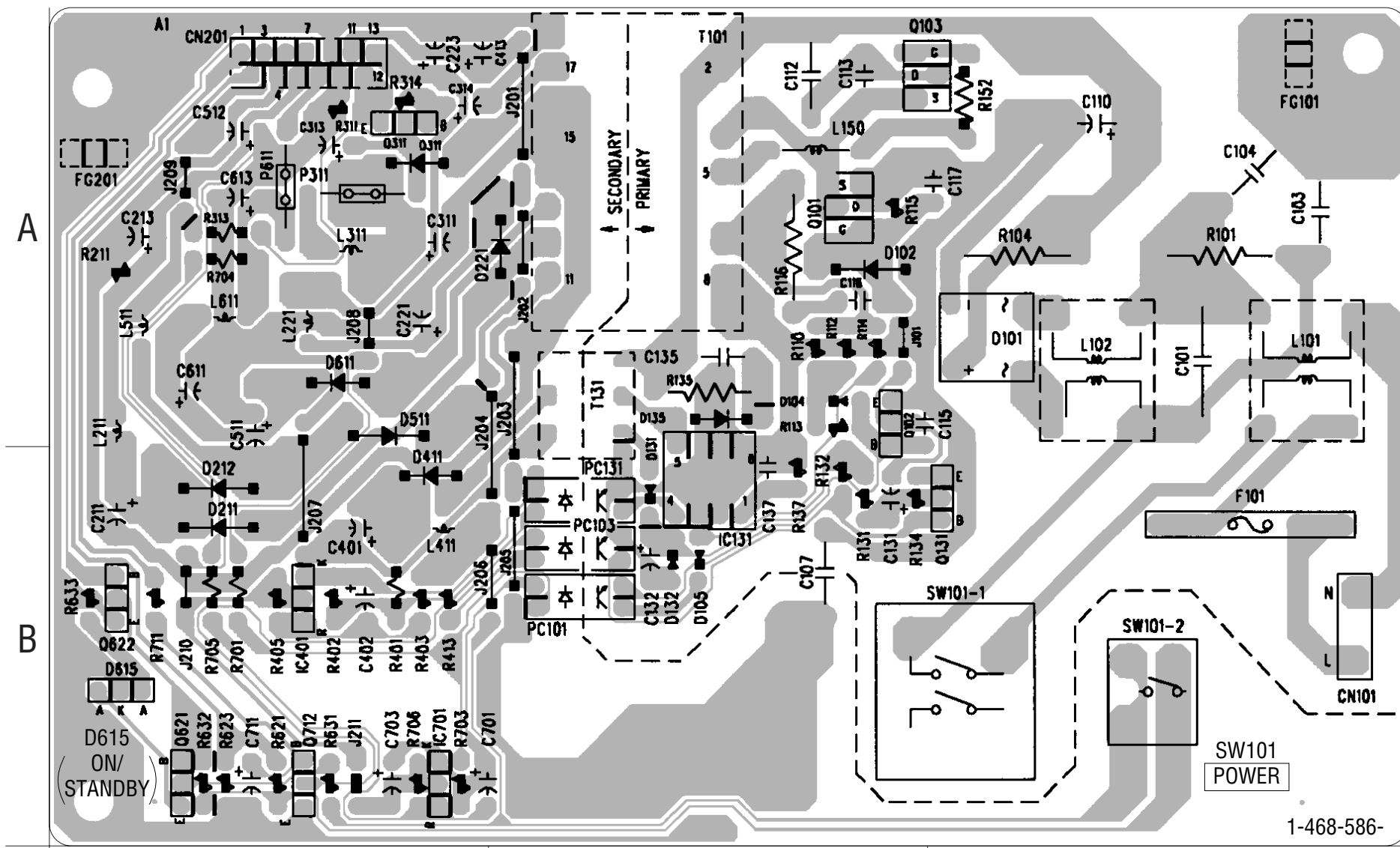

- Power Block (TOP-244U)
(US, Canadian, Mexican)
- Power Block (HS13S0U)
(US, Canadian, Mexican, Taiwan)
- Power Block (HS13S0E)
(AEP, UK, Russian, 220-240V AC Area in E, Saudi Arabia, Middle East, Argentina, Hong Kong, Korea, Singapore, Australian)
- Power Block (HS13S0F)
(110-240V AC Area in E, Brazilian, PX)
(SWITCHING REGULATOR)

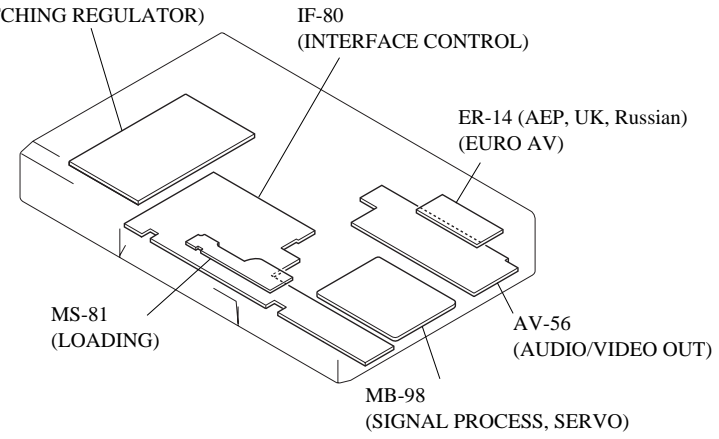

HS13S0F (SWITCHING REGULATOR) SCHEMATIC DIAGRAM

– Ref. No.: HS13S0F board; 4,000 series –
 – BR, E32, PX –

The components identified by mark \triangle or dotted line with mark \triangle are critical for safety. Replace only with part number specified.

Les composants identifiés par une marque \triangle sont critiques pour la sécurité. Ne les remplacer que par une pièce portant le numéro spécifié.

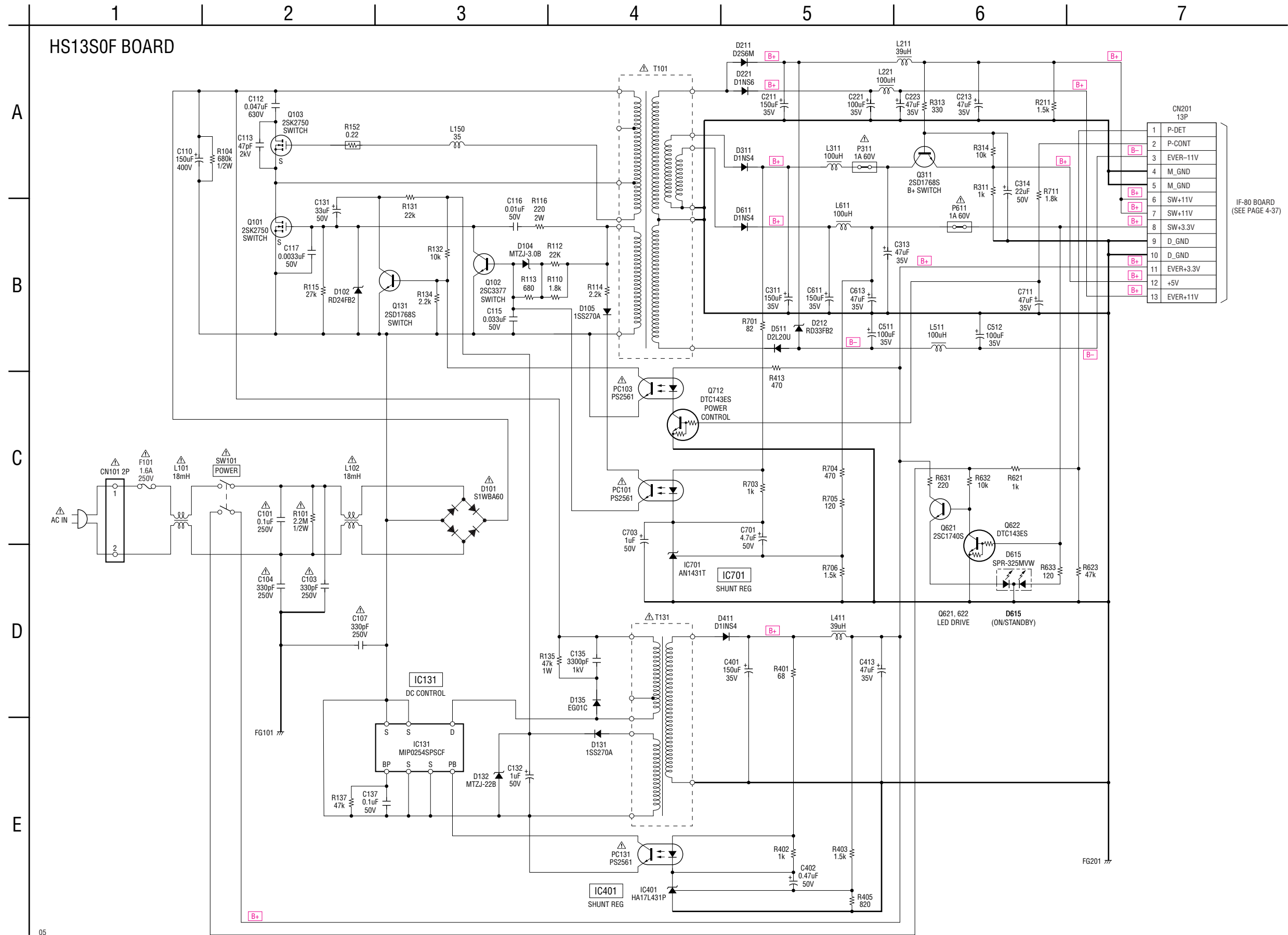

IF-80 BOARD
(SEE PAGE 4-37)

HS13S0U (SWITCHING REGULATOR) PRINTED WIRING BOARD

- Ref. No.: HS13S0U board; 5,000 series -
 - US, CND, MX, TW -

There are a few cases that the part isn't mounted in this model is printed on this diagram.

HS13S0U BOARD

HS13S0U BOARD

- CN101 B-3
- CN201 A-1
- D101 A-3
- D104 A-2
- D105 A-2
- D211 B-2
- D212 A-1
- D221 A-2
- D311 A-2
- D413 A-2
- D511 A-2
- D611 A-2
- D621 B-1
- IC301 B-2
- IC411 A-1
- Q101 A-3
- Q102 A-2
- Q211 B-1
- Q311 A-1
- Q411 A-2
- Q611 A-1
- Q621 B-1
- Q622 B-1
- Q712 A-1

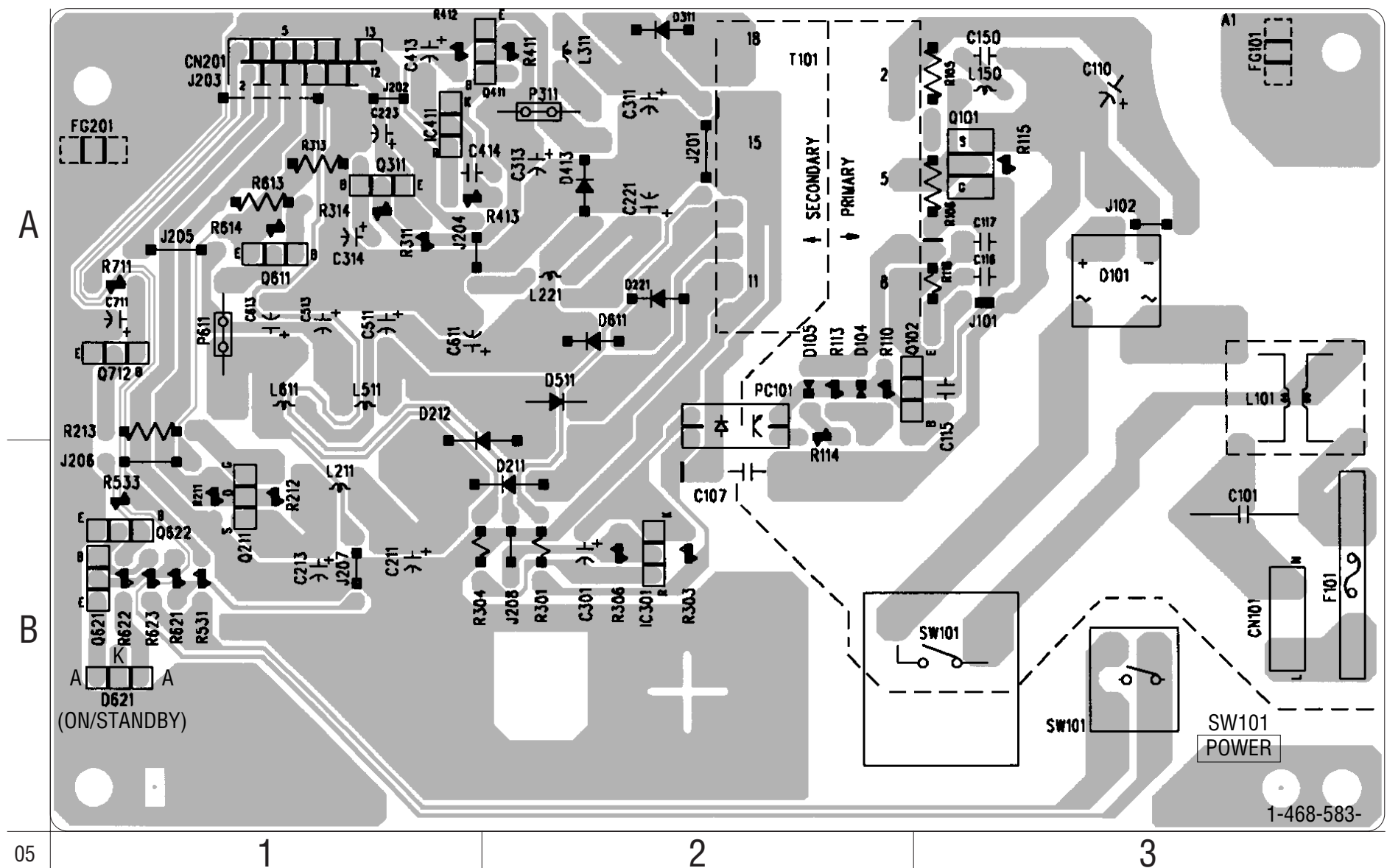

- Power Block (TOP-244U)
(US, Canadian, Mexican)
- Power Block (HS13S0U)
(US, Canadian, Mexican, Taiwan)
- Power Block (HS13S0E)
(AEP, UK, Russian, 220-240V AC Area in E, Saudi Arabia, Middle East, Argentina, Hong Kong, Korea, Singapore, Australian)
- Power Block (HS13S0F)
(110-240V AC Area in E, Brazilian, PX)
(SWITCHING REGULATOR)

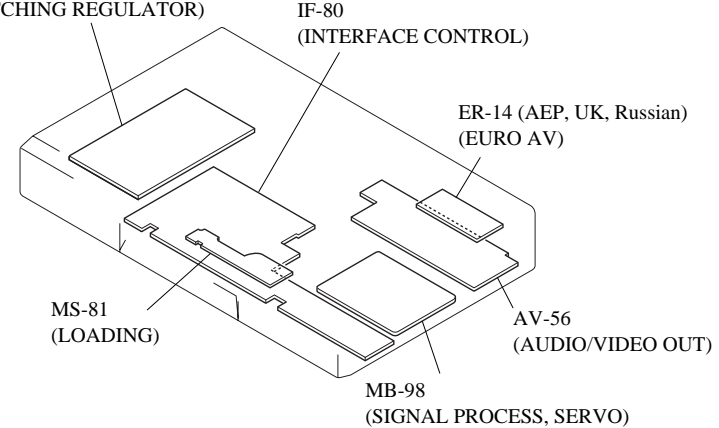

HS13S0U (SWITCHING REGULATOR) SCHEMATIC DIAGRAM

- Ref. No.: HS13S0U board; 5,000 series -
- US, CND, MX, TW -

The components identified by mark \triangle or dotted line with mark \triangle are critical for safety. Replace only with part number specified.

Les composants identifiés par une marque \triangle sont critiques pour la sécurité. Ne les remplacer que par une pièce portant le numéro spécifié.

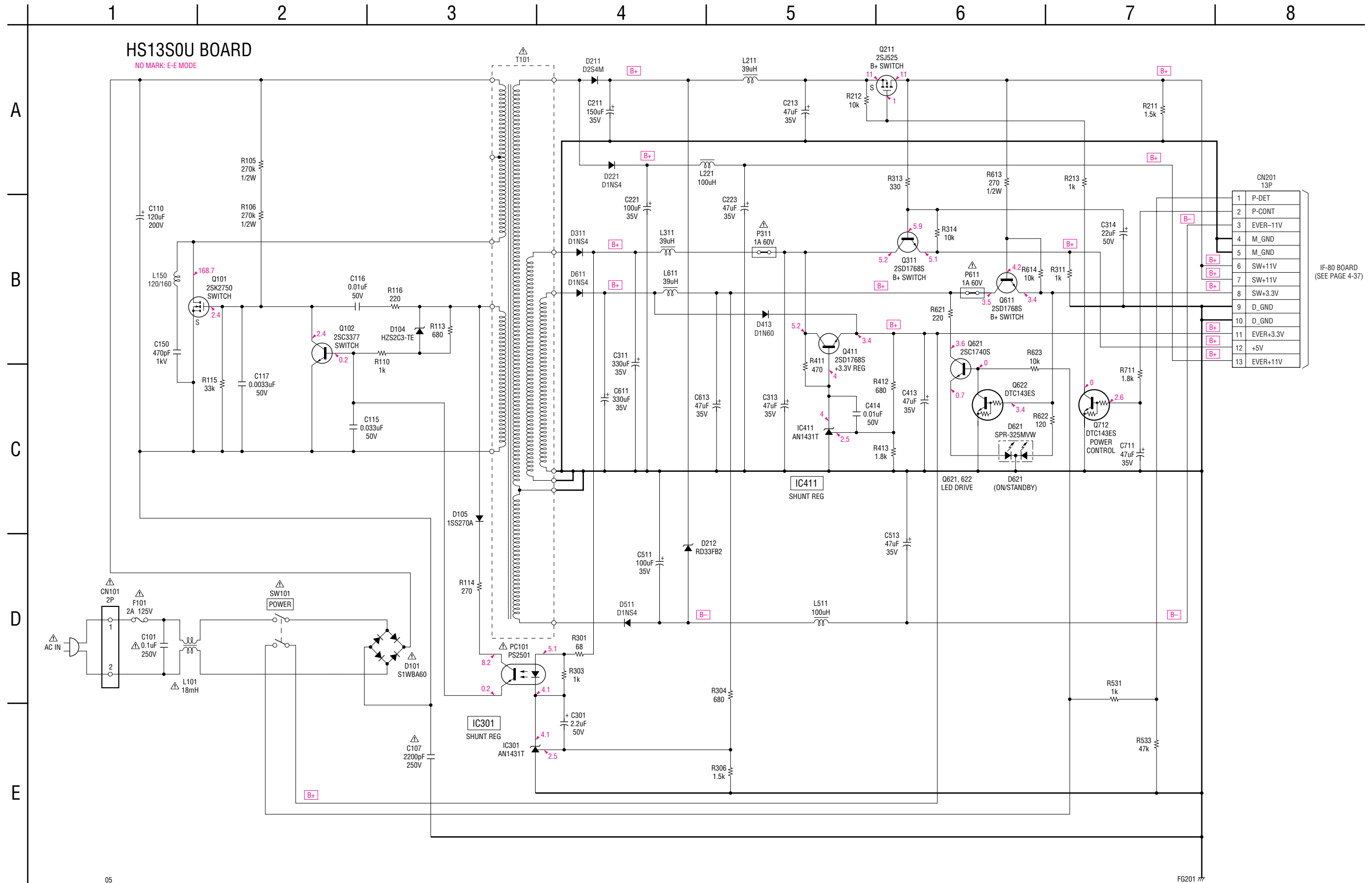

05

FG201 77

TOP-244U (SWITCHING REGULATOR) PRINTED WIRING BOARD

- Ref. No.: TOP-244U board; 6,000 series -
 - US, CND, MX -

There are a few cases that the part isn't mounted in this model is printed on this diagram.

TOP-244U BOARD

TOP-244U BOARD

CN900	B-3
CN920	A-1
D901	A-3
D902	A-3
D903	A-3
D904	A-3
D910	A-2
D911	A-2
D913	A-2
D920	A-2
D921	A-2
D922	A-1
D923	B-1
D925	A-1
D926	A-1
D927	A-1
D928	B-1
D929	B-1
D930	B-1
D931	B-1
D932	B-1
D933	A-1
IC910	A-2
IC920	B-1
Q922	A-2
Q923	A-2
Q924	A-1
Q925	A-1
Q927	A-1
Q928	B-1
Q929	B-1
Q930	B-2

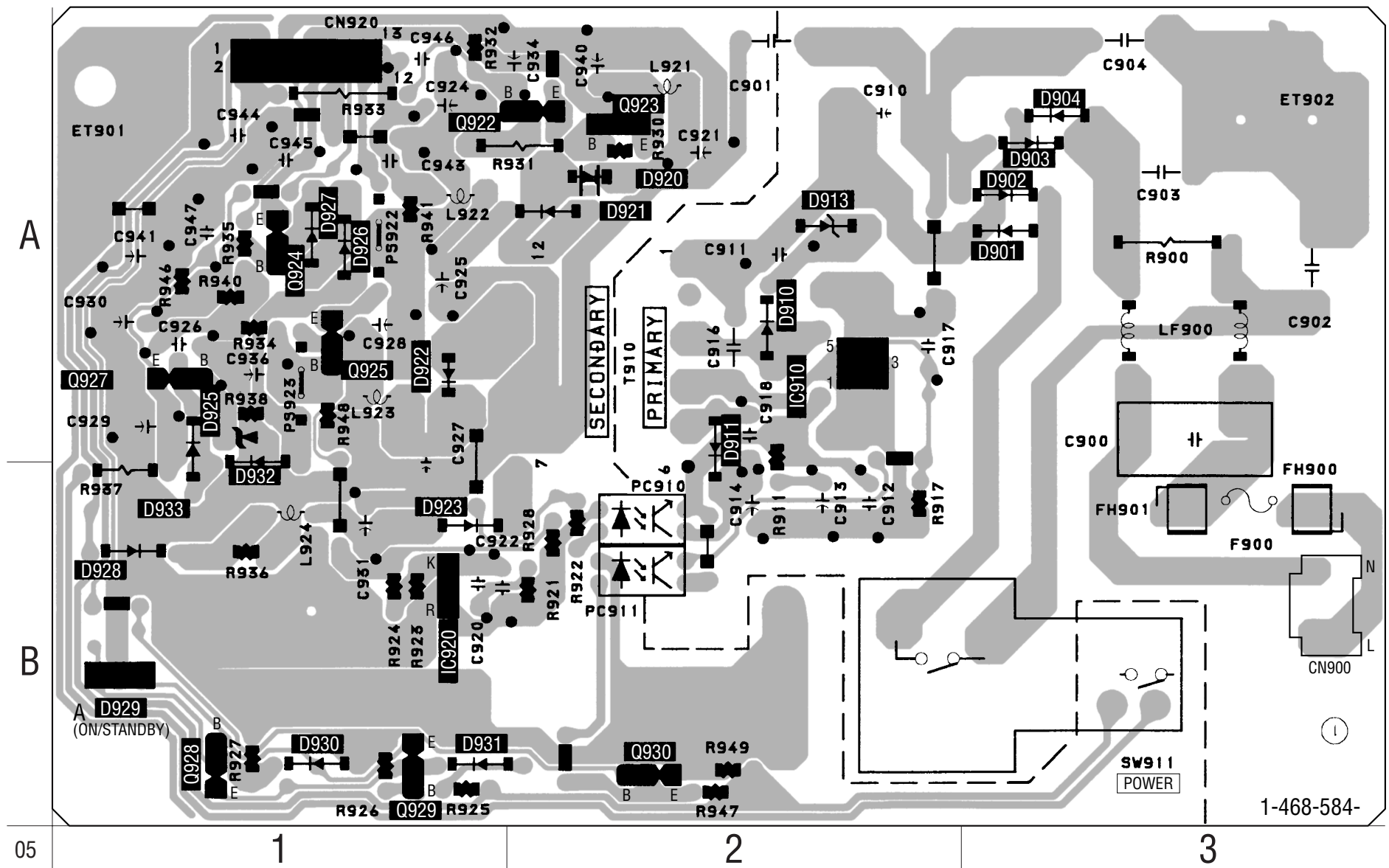

- Power Block (TOP-244U)
(US, Canadian, Mexican)
- Power Block (HS13S0U)
(US, Canadian, Mexican, Taiwan)
- Power Block (HS13S0E)
(AEP, UK, Russian, 220-240V AC Area in E, Saudi Arabia, Middle East, Argentina, Hong Kong, Korea, Singapore, Australian)
- Power Block (HS13S0F)
(110-240V AC Area in E, Brazilian, PX)
(SWITCHING REGULATOR)

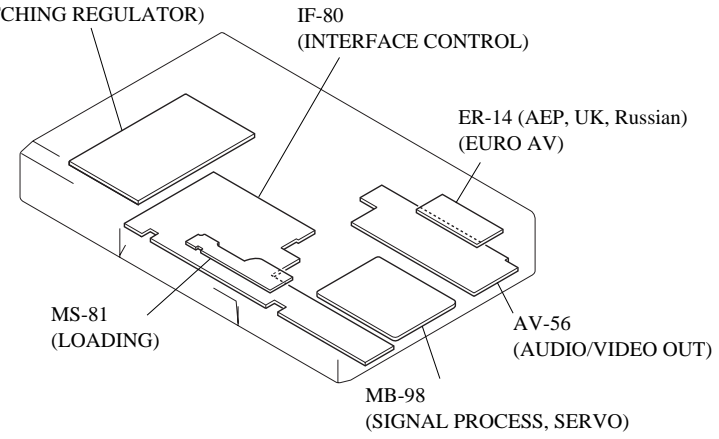

TOP-244U (SWITCHING REGULATOR) SCHEMATIC DIAGRAM
 – Ref. No.: TOP-244U board; 6,000 series –
 – US, CND, MX –

The components identified by mark \triangle or dotted line with mark \triangle are critical for safety. Replace only with part number specified.
 Les composants identifiés par une marque \triangle sont critiques pour la sécurité. Ne les remplacer que par une pièce portant le numéro spécifié.

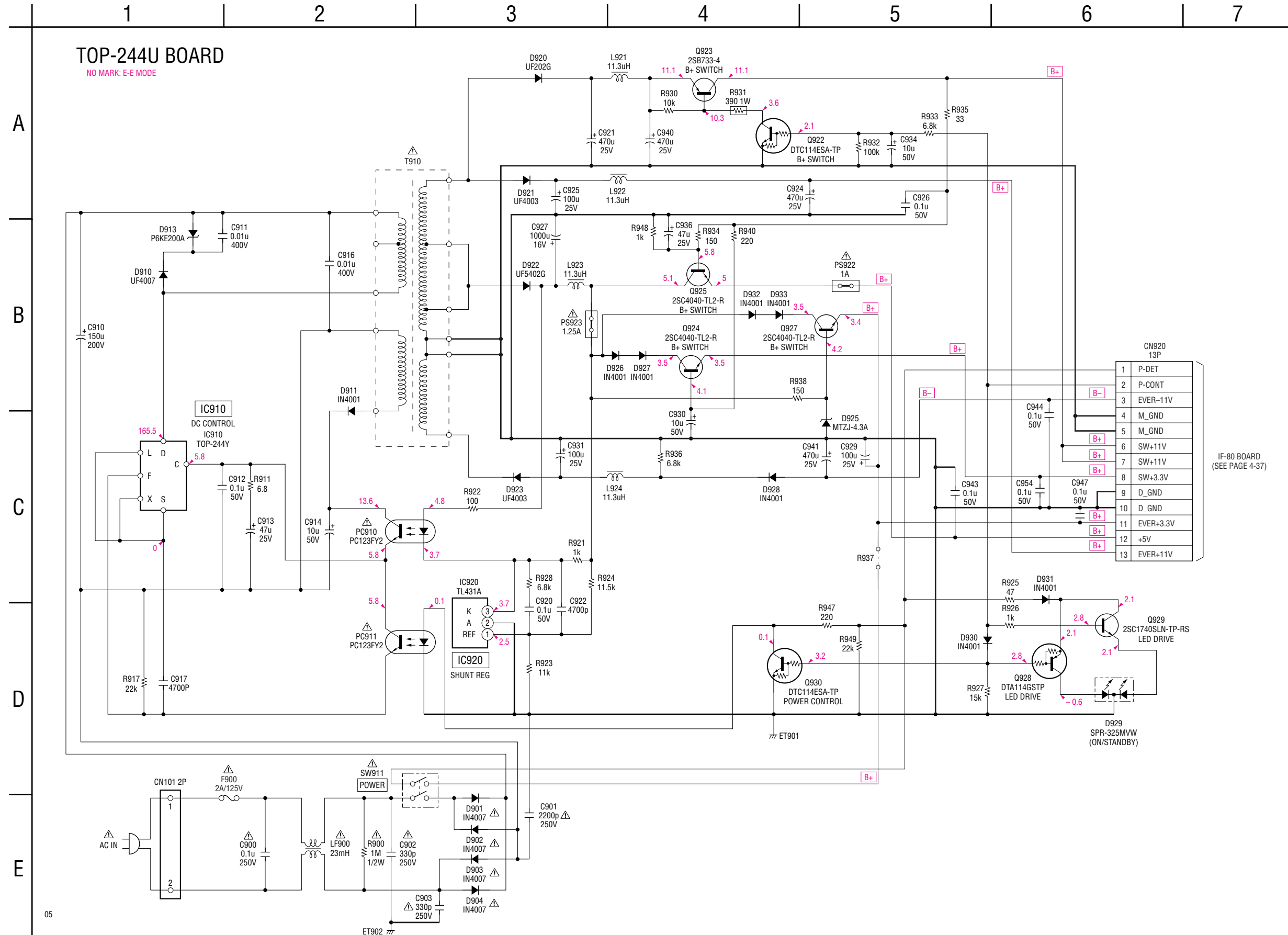

SECTION 5

IC PIN FUNCTION DESCRIPTION

5-1. SYSTEM CONTROL PIN FUNCTION (MB-98 BOARD IC103)

Pin No.	Pin name	I/O	Function
1-5	HA17-HA21	O	Address bus A17-A21
6	HA22	-	Not used
7	WP	O	Write control signal output to EEPROM
8	TRM-/XKRCS	-	Not used
9	AVCC	-	Power supply
10	AVRH	-	Reference power supply (+3.3 V)
11	AVSS	-	Ground
12	AN0	I	Set of mode 0
13	AN1	I	Set of mode 1
14	AN2	I	Set of mode 2
15	AN3	I	Set of mode 3
16	INT0	I	Input of interrupt from AV DEC
17	INT1	I	Input of interrupt from ARP
18	INT2	I	Input of interrupt from servo DSP
19	INT3	-	Not used
20	INT4	I	Input of interrupt from IF CON
21	INT5	-	Not used
22	INT6	-	Not used
23	INT7	-	Not used
24	VCC	-	Power supply
25	SI0	I	Serial data input from IF CON
26	SO0	O	Serial data output to IF CON
27	SC0	O	Serial clock output to IF CON
28	SI1	I	Serial bus 1 (for data input)
29	SO1	O	Serial bus 1 (for data output)
30	SC1	O	Serial clock output
31	SI2	I	Serial bus 2 (for data input)
32	SO2	O	Serial bus 2 (for data output)
33	DSENS	-	Not used
34	VSS	-	Ground
35	XRST	O	System reset signal output
36	XARPRST	O	Reset signal output for ARP
37	RGBSEL/MICMUTE	O	RGB signal select signal output/Mic mute signal output
38	SDA	I/O	I2C bus serial data input/output

Pin No.	Pin name	I/O	Function
39	SCL	O	I2C bus serial clock output
40	TRM+/XKRRRST	-	Not used
41	EUROV/Y/CLAPSW1	O	EURO V/Y select signal output/Mute signal output to video buffer
42	DISCEXT/CLPSW0	O	Line input select signal output (DISC: "H", EXT: "L")
43	MD0	I	Input of mode select 0 (fixed at "H")
44	MD1	I	Input of mode select 1 (fixed at "L")
45	MD2	I	Input of mode select 2 (fixed at "L")
46	DREQ0	I	Input of DMA-REQ 0 from AV DEC
47	DACK0	O	Output of DMA-ACK 0 to AV DEC
48	XDRVMUTE	O	Drive mute signal output
49	DREQ1	I	Input of DMA-REQ 1 from AV DEC
50	DACK1	O	Output of DMA-ACK 1 to AV DEC
51	XIFCS	O	Chip select signal to IF CON
52	VSS	-	Ground
53	X1	O	Clock output (16.5 MHz)
54	X0	I	Clock input (16.5 MHz)
55	VCC	-	Power supply
56	CKSW1	I	Chuck sensor input
57	OCSW1	I	Tray sensor input
58	CS0X	O	External ROM chip select signal output
59	CS1X	-	Not used
60	CS2X	O	Chip select signal output (for AV DEC)
61	CS3X	O	Chip select signal output (for AV DEC)
62	CS4X	O	Chip select signal output (for ARP)
63	CS5X	O	Chip select signal output (for servo DSP)
64	C	-	Capacitor (0.1uF) connect between ground
65	CS6X	-	Not used
66	CS7X	-	Not used
67	XWAIT	I	Wait signal input
68	BGRNTX	-	Test terminal (fixed at "H")
69	BRQ	-	Test terminal
70	XRD	O	Read enable signal output

Pin No.	Pin name	I/O	Function
71	XWRH	O	High byte write enable signal output (16 bit and 8 bit)
72	XWRL	-	Not used
73	NMIX	-	Not used (fixed at "H")
74	HSTX	-	Not used (fixed at "H")
75	VSS	-	Ground
76	XFRRST	I	Reset signal input from IF CON
77	CPUCK	O	CPU clock signal output
78	OCSW2	-	Not used
79	XDACS	O	Chip select signal output to DAC (2ch, 6ch)
80	VESCS/X39CS	O	Chip select signal output to DSP
81	48/44.1K	O	PLL FS control signal output
82	WIDE	O	WIDE select signal output
83	MAMUTE	O	Audio mute signal output
84	XLDON	O	LD control signal output
85-92	HD0-HD7	I/O	Data bus D0-D7 (16 bit only)
93-100	HD8-HD15	I/O	Data bus D8-D15 (16 bit), D0-D7 (8 bit)
101	VSS	-	Ground
102-109	HA0-HA7	O	Address bus A00-A07
110	VCC	-	Power supply
111-118	HA8-HA15	O	Address bus A08-A15
119	VSS	-	Ground
120	HA16	O	Address bus A16

SECTION 6 TEST MODE

6-1. GENERAL DESCRIPTION

The Test Mode allows you to make diagnosis and adjustment easily using the remote commander and monitor TV. The instructions, diagnostic results, etc. are given on the on-screen display (OSD).

Note: Since the remote commander belongs to this model has no number buttons, use other DVD remote commander with number buttons on it.

6-2. STARTING TEST MODE

Press the **[TITLE]**, **[CLEAR]**, **[POWER]** keys on the remote commander in this order with the power of main unit in OFF status, and the Test Mode starts, then "DIAG START" will be displayed on the fluorescent display tube and the menu shown below will be displayed on the TV screen. At the bottom of menu screen, the model name and revision number are displayed. Last Off at the lower right of screen indicates the information code concerning the last power off.

To execute each function, select the desired menu and press its number on the remote commander.

To exit from the Test Mode, press the **[POWER]** key.

```

Test Mode Menu

0. Syscon Diagnosis
1. Drive Auto Adjustment
2. Drive Manual Operation
3. Mecha Aging
4. Emergency History
5. Version Information
6. Video Level Adjustment
   Exit: POWER Key
-
Model : DPX-14xxxx
Revision : 1.xxxx Last Off: xx

```

Power Off Information Code List

- 00 : Primary Power Off
- 01 : Power Off Request from SYSTEM CONTROL
- 02 : Power Off by Emergency Power Off Command from SYSTEM CONTROL
(if information is sent from SYSTEM CONTROL)
- 03 : IF CON Judged that SYSTEM CONTROL is Faulty
- 04 : Power Off from Diagnosis Mode of IF CON
- 05 : Forced Power Off by the User
- 06 : Power Off by Power Supply Voltage Monitor

6-3. SYSCON DIAGNOSIS

The same contents as board detail check by serial interface can be checked from the remote commander.

On the Test Mode Menu screen, press **[0]** key on the remote commander, and the following check menu will be displayed.

```

### Syscon Diagnosis ###
      Check Menu

0. Quit
1. All
2. Version
3. Peripheral
4. Servo
5. Supply
6. AV Decoder
7. Video
8. Audio
-

```

0. Quit

Quit the Syscon Diagnosis and return to the Test Mode Menu.

1. All

All items continuous check

This menu checks all diagnostic items continuously. Normally, all items are checked successively one after another automatically unless an error is found, but at a certain item that requires judgment through a visual check to the result, the following screen is displayed for the key entry.

```

### Syscon Diagnosis ###

      Diag All Check
      No. 2 Version

2-3. ROM Check Sum
Check Sum = xxxx

Press NEXT Key to Continue
Press PREV Key to Repeat
-

```

For the ROM Check, the check sum calculated by the Syscon is output, and therefore you must compare it with the specified value for confirmation.

Following the message, press **[NEXT]** key to go to the next item, or **[PREV]** key to repeat the same check again. To quit the diagnosis and return to the Check Menu screen, press **[STOP]** or **[ENTER]** key. If an error occurred, the diagnosis is suspended and the error code is displayed as shown below.

```

### Syscon Diagnosis ###

3-3. EEPROM Check
Error 03: EEPROM Write/Reed N
Address   : 00000001
Write Data : 2492
Read Data  : 2490
Press NEXT Key to Continue
Press PREV Key to Repeat
-

```

Press **[STOP]** key to quit the diagnosis, or **[PREV]** key to repeat the same item where an error occurred, or **[NEXT]** key to continue the check from the item next to faulty item.

Submenu

Selecting 2 and subsequent items calls the submenu screen of each item.

For example, if “5. Supply” is selected, the following submenu will be displayed.

```

### Syscon Diagnosis ###
      Check Menu
      No. 5 Supply
0. Quit
1. All
2. ARP Register Check
3. ARP to RAM Data Bus
4. ARP to RAM Address Bus
5. ARP RAM Check
-
    
```

0. Quit

Quit the submenu and return to the main menu.

1. All

All submenu items continuous check.

This menu checks 2 and subsequent items successively. At the item where visual check is required for judgment or an error occurred, the checking is suspended and the message is output for key entry. Normally, all items are checked successively one after another automatically unless an error is found.

Selecting 2 and subsequent items executes respective menus and outputs the results.

For the contents of each submenu, see “General Description of Checking Method” and “Check Items List”.

General Description of Checking Method

2. Version

(2-2) Revision

ROM revision number is displayed.

Error: Not detected.

The revision number defined in the source file of ROM (IC107) is displayed with four digits.

(2-3) ROM Check Sum

Check sum is calculated.

Error: Not detected.

8-bit data are added up to the ROM (IC107) address 0x000F0000 to 0x002EFFFF, and the result is displayed with 4-digit hexadecimal number. Error is not detected.

Compare the result with the specified value.

(2-4) Model Type

Model code is displayed.

Error: Not detected.

The model code read from the EEPROM is displayed with 2-digit hexadecimal number.

	Model Type	
US, CND, PX	0	0
AR, E32, MX	0	2
AEP (DPX1401BM, DPX1401HM), UK	0	3
AEP (DPX1402BM, DPX1402HM)	0	4
RUS	0	5
BR	0	6
HK, KR, SP, TW	0	7
E12	0	8
EA, ME	0	9
AUS	0	A

• Abbreviation

AR	: Argentina	HK	: Hong Kong
AUS	: Australian	KR	: Korea
BR	: Brazilian	ME	: Middle East
CND	: Canadian	MX	: Mexican
EA	: Saudi Arabia	RUS	: Russian
E12	: 220 – 240 V AC Area in E	SP	: Singapore
E32	: 110 – 240 V AC Area in E	TW	: Taiwan

• Description about model name

DPX14xxBM

Color of set

B : Black

H : Titanium gray

(2-5) Region

Region code is displayed.

Error: Not detected.

The region code determined from the model code is displayed.

(2-6) AD 3 PORT Check

AD 3 PORT status is displayed.

Error: Not detected.

Which status, High (Pull Up), NC (Non Connect), or Low (Pull Down), the AD 3 PORT is placed in now is checked.

3. Peripheral

(3-2) Gate Array Check

Data write → read, and accord check

Error 02: Gate array write/read discord

Data of 0x00 to 0xFF is written sequentially to the address 0xF and then read for checking.

(3-3) EEPROM Check

Data write → read, and accord check

Error 03: EEPROM write/read discord

0x9249, 0x2942 and 0x4294 are written to the address 0x00 to 0xFF of the EEPROM and then read for checking. Before writing, the data are saved, then after checking, they are written to restore the contents of EEPROM.

4. Servo

(4-2) Servo DSP Check

Data write → read, and accord check

Error 12: Read data discord

0x9249, 0x2942 and 0x4294 are written to the RAM address 0x602 of the Servo DSP and then read for checking. Also, OPT type “1 LASER” or “2 LASER” is displayed.

(4-3) DSP Driver Test

Test signal data → DSP Driver

Error: Not detected.

Caution: Do not perform this checking with the mechanical deck connected.

The maximum voltage is applied to the Servo Driver IC (IC401). If the mechanical deck is connected, it will be destroyed immediately. Following the output message, disconnect the mechanical deck, then enter the specified 4- or 5-digit value from the commander, and press the **[ENTER]** key. The test is conducted only if the entered value accords. To exit the test, check the output level, then press **[NEXT]** key.

This check is not conducted, but skipped in “All” menu item.

Supplement: How to disconnect mechanical deck

Disconnect flexible flat cables connected to the CN201 and CN202 of MB-98 board. Also, disconnect flat cable from the CN402.

5. Supply

(5-2) ARP Register Check

Data write → read, and accord check

Error 08: ARP register write, and read data discord

Data 0x00 to 0xFF is written sequentially to the ARP TMAX register (address 0xC6) and then read for checking.

(5-3) ARP to RAM Data Bus

Data write → read, and accord check

Error 09: ARP ↔ RAM data bus error

Data 0x0001 to 0x8000 where one bit each is set to 1 are written to the address 0 of RAM (IC303) connected to the ARP (IC302) through the bus, then they are read and checked. In case of discord, written bit pattern and read data are displayed. If data where multiple bits are 1 are read, the bits concerned may touch each other. Further, if data where certain bit is always 1 or 0 regardless of written data, the line could be disconnected or shorted.

(5-4) ARP to RAM Address Bus

Data write → other address read discord check

Error 10: ARP ↔ RAM address bus error

Caution: Address and data display in case of an error is different from the display of other diagnosis (described later).

Before starting the test, all addresses of RAM (IC303) are cleared to 0x0000.

First, 0xA55A is written to the address 0x00000, and the address data are read and checked from addresses 0x00001 to 0x80000 while shifting 1 bit each. Next, the data at that address is cleared, and it is written to the address 0x00001, and read and checked in the same manner. This check is repeated up to the address 0x80000 while shifting the address data by 1 bit each.

If data other than 0 is read at the addresses except written address, an error is given because all addresses were already cleared to 0. In this check, the error display pattern is different from that of other diagnosis; read data, written

address, and read address are displayed in this order. However, the message uses same template, and accordingly exchange Address and Data when reading. The following display, for example,

```
### Syscon Diagnosis ###
```

```
5-4. ARP to RAM Address Bus
Error 10: ARP - RAM Address B
Address   : 0000A55A
Write Data: 00000000
Read Data : 00080000
Press NEXT Key to Continue
Press PREV Key to Repeat
-
```

shows the data 0xA55A was read from address 0x00080000 though it was written to the address 0x00000000. This implies that these addresses are in the form of shadow. Also, if the read data is not 0xA55A, another error will be present.

(5-5) ARP RAM Check

Data write → read, and accord check

Error 11: ARP RAM read data discord

The program code data stored in ROM are copied to all areas of RAM (IC303) connected to the ARP (IC302) through the bus, then they are read and checked if they accord. If the detail check was selected initially, the data are written to all areas and read, then the same test is conducted once again with the data where all bits are inverted between 1 and 0. If discord is detected, faulty address, written data, and read data are displayed following the error code 11, and the test is suspended.

6. AV Decoder

(6-2) 1930 RAM

Data write → read, and accord check

Error 13: AVD RAM read data discord

The program code data stored in ROM (IC107) are copied to all areas of RAM (IC504, IC505) connected to the AVD (IC503) through the bus, then they are read and checked if they accord. Further, the same test is conducted once again with the data where all bits are inverted between 1 and 0. If discord is detected, faulty address, written data, and read data are displayed following the error code 13, and the test is suspended.

During the test, OSD display becomes blank as the OSD area is also checked.

(6-3) 1930 SP

ROM → AVD RAM → Video OUT

Error: Not detected.

The data including sub picture streams in ROM (IC107) are transferred to the RAM (IC504, IC505) in AVD (IC503), and output as video signals from the AVD (IC503).

Though OSD display becomes blank, the output of video signals continues until the key is pressed.

They are output from all video terminals (Composite, Y/C, Component) except EURO AV terminal.

7. Video

- (7-2) Color Bar
AVD color bar command write → Video OUT
Error: Not detected.
The command is transferred to the AVD, and the color bar signals are output from video terminals.
They are output from all video terminals (Composite, Y/C, Component) except EURO AV terminal.
- (7-3) Composite Out (AEP, UK, RUS Model)
EURO-AV Composite video output check
AVD color bar command write → Video (EURO-AV Composite) OUT
Error: Not detected.
With the Component of video output turned off, the color bar signals are output from the EURO-AV terminal.
- (7-4) Y/C Out (AEP, UK, RUS Model)
EURO-AV Y/C video output check
AVD color bar command write → Video (EURO-AV Y/C) OUT
Error: Not detected.
With the Y/C of video output turned on, the color bar signals are output from the EURO-AV terminal.
- (7-5) RGB Out (AEP, UK, RUS Model)
EURO-AV RGB video output check
AVD color bar command write → Video (EURO-AV RGB) OUT
Error: Not detected.
With the RGB of video output turned on, the color bar signals are output from the EURO-AV terminal.
- (7-6) Component Out (AEP, UK, RUS Model)
EURO-AV Component video output check
AVD color bar command write → Video (EURO-AV Component) OUT
Error: Not detected.
With the Component of video output turned on, the color bar signals are output from the EURO-AV terminal.

8. Audio

- (8-2) ARP → 1930
Error 14 : ARP → 1930 video NG
15 : ARP → 1930 audio NG
- (8-3) Test Tone
A pink noise signal is output from the AVD (IC503) through optical coaxial digital terminal and analog audio terminal.
Error: Not detected.
After turning on all outputs, each time the **[NEXT]** key is pressed, the output channel is switched for individual channel checking.
Left + Right → Left → Right are checked in this order.

Check Items List

- 2) Version
 - (2-2) Revision
 - (2-3) ROM Check Sum
 - (2-4) Model Type
 - (2-5) Region
- 3) Peripheral
 - (3-2) Gate Array Check
 - (3-3) EEPROM Check
- 4) Servo
 - (4-2) Servo DSP Check
 - (4-3) DSP Driver Test
- 5) Supply
 - (5-2) ARP Register Check
 - (5-3) ARP to RAM Data Bus
 - (5-4) ARP to RAM Address Bus
 - (5-5) ARP RAM Check
- 6) AV Decoder
 - (6-2) 1930 RAM
 - (6-3) 1930 SP
- 7) Video
 - (7-2) Color Bar
 - (7-3) Composite Out (AEP, UK, RUS Model)
 - (7-4) Y/C Out (AEP, UK, RUS Model)
 - (7-5) RGB Out (AEP, UK, RUS Model)
 - (7-6) Component Out (AEP, UK, RUS Model)
- 8) Audio
 - (8-2) ARP → 1930
 - (8-3) Test Tone

Error Codes List

- 00: Error not detected
- 01: RAM write/read data discord
- 02: Gate array NG
- 03: EEPROM NG
- 04: Flash memory clear error
- 05: Flash memory write error
- 06: Flash memory read data discord
- 07: 2725 read data discord
- 08: ARP register read data discord
- 09: ARP ↔ RAM data bus error
- 10: ARP ↔ RAM address bus error
- 11: ARP RAM read data discord
- 12: Servo DSP NG
- 13: 1930 SDRAM NG
- 14: ARP → 1930 video NG
- 15: ARP → 1930 audio NG
- 16: 1910 UCODE download NG
- 17: System call error (function not supported)
- 18: System call error (parameter error)
- 19: System call error (illegal ID number)
- 20: System call error (time out)
- 21: NAND Flash faulty blocks exceed 10
- 90: Error occurred
- 91: User verification NG
- 92: Diagnosis cancelled

6-4. DRIVE AUTO ADJUSTMENT

On the Test Mode Menu screen, press **[1]** key on the remote commander, and the drive auto adjustment menu will be displayed.

```
## Drive Auto Adjustment ##

      Adjustment Menu

0. ALL
1. DVD-SL
2. CD
3. DVD-DL
4. LCD

Exit: RETURN
```

Normally, **[0]** is selected to adjust DVD (single layer), CD, DVD (dual layer), and LCD (SACD) in this order. But, individual items can be adjusted for the case where adjustment is suspended due to an error. In this mode, the adjustment can be made easily through the operation following the message displayed on the screen. Which disc is currently adjusted is displayed on the fluorescent display tube.

The disc used for adjustment must be the one specified for adjustment.

0. ALL

You will be asked if EEPROM data are initialized or not, and for this prompt, select **[0]** and press the **[ENTER]** key. First, the servo setting data in EEPROM, Emergency History and Hour Meter are cleared to initialize. Then, 1. DVD-SL disc, 2. CD disc, 3. DVD-DL disc, and 4. LCD disc (SACD disc) are adjusted in this order. Each time one disc was adjusted, it is ejected, and therefore exchange the disc following the message. Though the message to confirm whether the discs is to be adjusted is not displayed except for LCD disk (SACD disk), you can exit the adjustment by pressing the **[STOP]** button. In adjusting each disc, the mirror time is measured to check the disk type. In the auto adjustment, whether the disc type is correct is not checked unlike conventional models, and accordingly, take care not to insert a different type of disc.

1. DVD-SL (single layer)

Select **[1]**, insert DVD single layer disc, and press **[ENTER]** key, and the adjustment will be made through the following steps, then adjusted values will be written to the EEPROM.

DVD Single Layer Disc Adjustment Steps

1. SLED TILT Reset
2. Disc Check Memory SL
3. Set Disc Type SL
4. Spdl Start
5. Wait 1 sec
6. LD ON
7. Focus Error Check
8. Focus ON 0
9. Auto Track Offset Adjust L0
10. Trv Level Check
11. Tracking ON
12. Wait 100 msec
13. CLVA ON
14. Wait 500 msec
15. Sled ON
16. Auto Loop Filter Offset Adjust
17. Auto Focus Gain Adjust L0
18. Auto Focus Balance Adjust L0
19. EQ Boost Adjust
20. Auto Loop Filter Offset Adjust
21. RF Level Measure
22. Jitter Disp ON
23. Jitter Memory
24. Jitter Disp OFF
25. Eep Copy Loop Filter Offset
26. All Servo Stop

2. CD

Select [2], insert CD disc, and press [ENTER] key, and the adjustment will be made through the following steps, then adjusted values will be written to the EEPROM.

CD Adjustment Steps

1. Sled Tilt Reset
2. Disc Check Memory CD
3. Set Disc Type CD
4. Spdl Start
5. Wait 1 sec
6. LD ON
7. Focus Error Check
8. Fcs ON 1
9. Auto Track Offset Adjust L0
10. Trv Level Check
11. Tracking ON
12. Wait 100 msec
13. CLVA ON
14. Wait 500 msec
15. Sled ON
16. Auto Loop Filter Offset Adjust
17. Auto Focus Gain Adjust L0
18. Auto Focus Balance Adjust L0
19. Eq Boost Adjust
20. Auto Loop Filter Offset Adjust
21. Auto Track Gain Adjust
22. RF Level Measure
23. Jitter Disp ON
24. Jitter Memory
25. Jitter Disp OFF
26. All Servo Stop

3. DVD-DL (dual layer)

Select [3], insert DVD dual layer disc, and press [ENTER] key, and the adjustment will be made through the following steps, then adjusted values will be written to the EEPROM.

DVD Dual Layer Disc Adjustment Steps

1. Sled Tilt Reset
2. Disc Check Memory DL
3. Set Disc Type DL

Layer 1 Adjust

4. Spdl Start (Wait 1 sec)
5. LD ON
6. Fcs ON 1
7. Auto Track Offset Adjust L1
8. Tracking ON
9. Wait 100 msec
10. Clva ON (Wait 500 msec)
11. Sled ON
12. Auto Focus Gain Adjust L1
13. Auto Focus Balance Adjust L1
14. Eq Boost Adjust L1
15. Auto Track Gain Adjust L1
16. Jitter Disp ON
17. Jitter Memory
18. Jitter Disp Off

Layer 0 Adjust

19. Focus Jump (L1 → L0)
20. Auto Track Offset Adjust L0
21. Tracking ON (Wait 100 msec)
22. Clva ON (Wait 500 msec)
23. Sled ON
24. Auto Focus Gain Adjust L0
25. Auto Focus Balance Adjust L0
26. Eq Boost Adjust L0
27. Auto Track Gain Adjust L0
28. Jitter Disp ON
29. Jitter Memory
30. Jitter Disp OFF
31. All Servo Stop

4. LCD

This model does not adjust it because the adjusted data of CD are reflected.

6-5. DRIVE MANUAL OPERATION

On the Test Mode Menu screen, select **[2]**, and the manual operation menu will be displayed. For the manual operation, each servo on/off control and adjustment can be executed manually.

```
## Drive Manual Operation ##

      Operation Menu
1. Disc type
2. Servo Control
3. Track/Layer Jump
4. Manual Adjustment
5. Auto Adjustment
6. Memory Check

0. Disc Check Memory

Exit: RETURN
```

In using the manual operation menu, take care of the following points. These commands do not provide protection, thus requiring correct operation. The sector address or time code field is displayed when a disc is loaded.

1. Set correctly the disc type to be used on the Disc Type screen.
The disc type must be set after a disc was loaded.
The set disc type is cleared when the tray is opened.
2. After power ON, if the Drive Manual Operation was selected, first perform "Reset SLED TILT" by opening 1. Disc Type screen.
3. In case of an alarm, immediately press the **[STOP]** button to stop the servo operation, and turn the power OFF.

Basic operation (controllable from front panel or remote commander)

[POWER]	Power OFF
[STOP]	Servo stop
[OPEN/CLOSE]	Stop+Eject/Loading
[RETURN]	Return to Operation Menu or Test Mode Menu
[NEXT], [PREV]	Transition between sub modes of menu
[1] to [9], [0]	Selection of menu items
Cursor UP/DOWN	Increase/Decrease in manually adjusted value

0. Disc Check Memory

```
Disc Check

1. SL Disc Check
2. CD Disc Check
3. DL Disc Check

0. Reset SLED TILT
```

On this screen, the mirror time is measured and written to the EEPROM to check the disc type. First, set a DVD SL disc and press **[1]**, then set a CD disc and press **[2]**, and finally set a DVD DL disc and press **[3]**. The measured mirror time is displayed respectively.

The adjustment must be executed more than once after default data were written.

Reference value for DVD is from 10 to 20, and for CD, from 28 to 4F. Check that the value of CD is larger than that of DVD. When those values are beyond a range perform this adjustment again. From this screen, you can go to another mode by pressing **[NEXT]** or **[PREV]** key, but you cannot enter this mode from another mode. You can enter this mode from the Operation Menu screen only.

1. Disc Type

```
Disc Type

1. Disc Type Auto Check
2. DVD SL 12 cm
3. DVD DL 12 cm
4. CD 12cm
5. LCD 12 cm
6. DVD SL 8 cm
7. DVD DL 8 cm
8. CD 8 cm
9. LCD 8 cm
0. Reset SLED TILT

EMG. 00
```

On this screen, select the disc type. To select the disc type, press the number of the loaded disc. The selected disc type is displayed at the bottom. Selecting **[1]** automatically selects and displays the disc type. In case of wrong display, retry "Disc Check Memory". Also, opening the tray causes the set disc type to be cleared. In this case, set the disc type again after loading.

In performing manual operation, the disc type must be set. Once the disc type has been selected, the sector address or time code display field will appear as shown below. These values are displayed when PLL is locked.

```
Disc Type

1. Disc Type Auto Check
2. DVD SL 12 cm
3. DVD DL 12 cm
4. CD 12cm
5. LCD 12 cm
6. DVD SL 8 cm
7. DVD DL 8 cm
8. CD 8 cm
9. LCD 8 cm
0. Reset SLED TILT

SA.----- SI.-- EMG. 00
DVD SL 12 cm
```

Display when DVD SL 12cm disc was selected

```

Disc Type
1. Disc Type Auto Check
2. DVD SL 12 cm
3. DVD DL 12 cm
4. CD 12cm
5. LCD 12 cm
6. DVD SL 8 cm
7. DVD DL 8 cm
8. CD 8 cm
9. LCD 8 cm
0. Reset SLED TILT
TC.-----:----- EMG. 00
CD 12 cm

```

Display when CD 12cm disc was selected

0 Reset SLED TILT Reset the Sled and Tilt to initial position.

1 Disc Type Check Judge automatically the loaded disc. As the judged result is displayed at the bottom of screen, make sure that it is correct.
If Disc Check Memory menu has not been executed after EEPROM default setting, the disc type cannot be judged. In this case, return to the initial menu and make a check for three types of discs (SL, DL, CD).

2 to **9** Select the loaded disc. The adjusted value is written to the address of selected disc. No further entry is necessary if **1** was selected.

2. Servo Control

```

Servo Control
1. LD Off R. Sled FWD
2. SP Off L. Sled REV
3. Focus Off
4. TRK. Off
5. Sled Off
6. CLVA Off
7. FCS. Srch Off

0. Reset SLED TILT
SA.----- SI.-- EMG. 00
DVD SL 12 cm

```

On this screen, the servo on/off control necessary for replay is executed. Normally, turn on each servo from 1 sequentially and when CLVA is turned on, the usual trace mode becomes active. In the trace mode, DVD sector address or CD time code is displayed. This is not displayed where the spindle is not locked. The spindle could run overriding the control if the spindle system is faulty or RF is not present. In such a case, do not operate CLVA.

0 Reset SLED TILT Reset the Sled and Tilt to initial position.

1 LD Turn ON/OFF the laser.

2 SP Turn ON/OFF the spindle.

3 Focus Search the focus and turn on the focus.

4 TRK Turn ON/OFF the tracking servo.

5 Sled Turn ON/OFF the sled servo.

6 CLVA Turn ON/OFF normal servo of spindle servo.

7 FCS. Srch Apply same voltage as that of focus search to the focus drive to check the focus drive system.

→ Sled FWD Move the sled outward. Perform this operation with the tracking servo turned off.

← Sled REV Move the sled inward. Perform this operation with the tracking servo turned off.

3. Track/Layer Jump

```

Tracking/Layer Jump
1. 1Tj FWD R. Fj (L1 → L0)
2. 1Tj REV L. Fj (L0 → L1)
3. 2Tj FWD U. Lj (L1 → L0)
4. 2Tj REV D. Lj (L0 → L1)
5. NTj FWD
6. NTj REV
7. 500Tj FWD
8. 500Tj REV
9. 10k/20k FWD
0. 10k/20k REV
SA.----- SI.-- EMG. 00
DVD SL 12 cm

```

On this screen, track jump, etc. can be performed. Only for the DVD-DL, the focus jump and layer jump are displayed in the right field.

1 1Tj FWD 1-track jump forward.

2 1Tj REV 1-track jump reverse.

3 2Tj FWD 2-track jump forward.

4 2Tj REV 2-track jump reverse.

5 NTj FWD N-track jump forward.

6 NTj REV N-track jump reverse.

7 500Tj FWD Fine search forward.

8 500Tj REV Fine search reverse.

9 10k/20k FWD Direct search forward.

0 10k/20k REV Direct search reverse.

– The following commands are valid for DVD-DL disc only –

→ Fj (L1 → L0) Focus jump forward. (Trk/Sled Servo OFF)

← Fj (L0 → L1) Focus jump reverse. (Trk/Sled Servo OFF)

↑ Lj (L1 → L0) Layer jump forward. (Trk/Sled Servo ON)

↓ Lj (L0 → L1) Layer jump reverse. (Trk/Sled Servo ON)

4. Manual Adjustment

```

Manual Adjustment
1. TRK. Offset
2. Focus Gain
3. TRK. Gain
4. Focus Offset
5. Focus Balance
6. L.F. Offset
7. EQ BOOST
8. GD ADJ
Adjustment : Up/Down
Jitter 1D
SA.----- SI.-- EMG. 00
DVD SL 12 cm

```

On this screen, each item can be adjusted manually. Select the desired number [1] to [8] from the remote commander, and current setting for the selected item will be displayed, then increase or decrease numeric value with [↑] key or [↓] key. This value is stored in the EEPROM. If CLV has been applied, the jitter is displayed for reference for the adjustment.

- [1] TRK. Offset Adjusts tracking offset.
- [2] Focus Gain Adjusts focus gain.
- [3] TRK. Gain Adjusts track gain.
- [4] Focus Offset Adjusts focus offset.
- [5] Focus Balance Adjusts focus balance.
- [6] L.F. Offset Adjusts loop filter offset.
- [7] EQ BOOST
- [8] GD ADJ

5. Auto Adjustment

```

Auto Adjustment
1. Auto TRK. Offset
2. Auto Focus Balance
3. Auto Focus Offset
4. Auto Focus Gain
5. Auto TRK. Gain
6. Auto EQ
7. Auto L.F. Offset
8. Auto Group Delay
SA.----- SI.-- EMG. 00
DVD SL 12 cm

```

On this screen, each item can be adjusted automatically. Select the desired number [1] to [8] from the remote commander, and selected item is adjusted automatically.

- [1] Auto TRK. Offset Adjusts tracking offset.
- [2] Auto Focus Balance Adjusts focus balance.
- [3] Auto Focus Offset Adjusts focus offset.
- [4] Auto Focus Gain Adjusts focus gain.
- [5] Auto TRK. Gain Adjusts track gain.

- [6] Auto EQ
- [7] Auto L.F. Offset Adjusts loop filter offset.
- [8] Auto Group Delay

6. Memory Check

```

EEPROM DATA 1      -- DL --
                  CD LCD SL L0 L1
Focus Gain        xx xx xx xx xx
TRK. Gain        xx xx xx xx xx
FCS Balance      xx xx xx xx xx
Focus Bias       xx xx xx xx xx
TRV. Offset      xx xx xx xx xx
L.F. Offset      xx xx xx xx xx
EQ Boost         xx xx xx xx xx
Mirror Time      xx -- xx xx
-
DOWN : Next Data
CLEAR: Default Set      page. 1/2

```

```

EEPROM DATA 2      -- DL --
                  CD LCD SL L0 L1
RF Jitter        xx -- xx xx xx
RF Level         xx -- xx -- --
FE Level         xx -- xx -- --
FE Balance       xx -- xx -- --
TRV. Level       xx -- xx -- --
Analog FRSW     xx xx xx xx xx
PLL Dac Gain    xx xx xx xx xx
-
UP : Prev Data
CLEAR: Default Set      page. 2/2

```

On this screen, current servo adjusted data stored in the EEPROM are displayed. The adjusted data are initialized by pressing the [CLEAR] key, but be careful that they are not recoverable after initialization.

Before clearing the adjusted data, make a note of the set data. This screen will also appear if [0] All is selected in the Drive Auto Adjustment. In this case, default setting cannot be made.

For reference, the drive has been designed so that the gain center value is 20 and offset value is 80. Other values will be in a range of 10 to 80. If extreme value such as 00 or FF is set, adjustment will be faulty. In such a case, check for disc scratch or cable disconnection, then perform adjustment again.

6-6. MECHA AGING

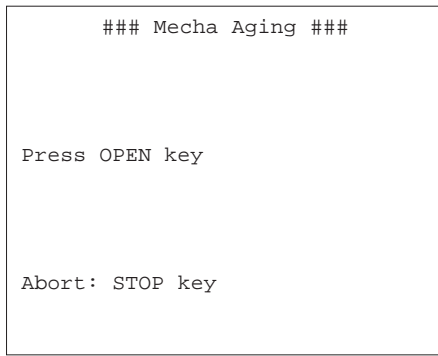

On the Test Mode Menu screen, selecting [3] executes the aging of mechanism. First, open the tray and load a disc. Press the [PLAY] key, and the aging will start. When the tray is closed, the disc type and size are judged and displayed. During aging, the repeat cycle is displayed. Aging can be aborted at any time by pressing the [STOP] key. After the operation has stopped, unload the disc and press again the [STOP] key or the [RETURN] key to return to the Test Mode Menu.

6-7. EMERGENCY HISTORY

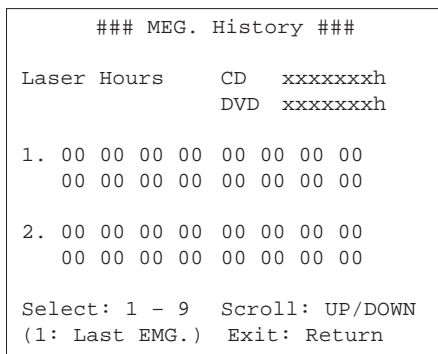

On the Test Mode Menu screen, selecting [4] displays the information such as servo emergency history. The history information from last 1 up to 10 can be scrolled with [↑] key or [↓] key. Also, specific information can be displayed by directly entering that number with ten keys.

The upper two lines display the laser ON total hours. Data below minutes are omitted.

Clearing History Information

Clearing laser hours

- Press [DISPLAY] and [CLEAR] keys in this order. Both CD and DVD data are cleared.

Clearing emergency history

- Press [TITLE] and [CLEAR] keys in this order.

Initializing set up data

- Press [DVD] and [CLEAR] keys in this order.

The data have been initialized when “Set Up Initialized” message is displayed. The EMG. History screen will be restored soon.

How to see Emergency History

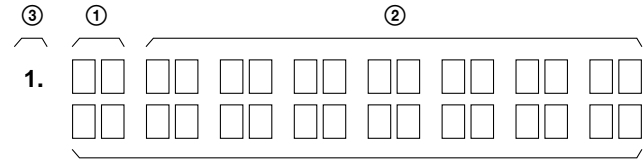

①: Emergency Code

②: Don't Care

These codes are used for verification of software designing.

③: Historical order 1 to 9

Emergency Codes List

- 10: Communication to IC202 (MB-98 board) failed.
- 11: Each servo for focus, tracking, and spindle is unlocked.
- 12: Communication to EEPROM, IC101 (MB-98 board) failed.
- 13: Writing of hours meter data to EEPROM, IC101 (MB-98 board) failed.
- 14: Communication to Servo DSP IC302 (MB-98 board) failed, or Servo DSP is faulty.
- 20: Initialization of tilt servo and sled servo failed. They are not placed in the initial position.
- 21: Tilt servo operation error
- 22: Syscon made a request to move the tilt servo to wrong position.
- 23: Sled servo operation error
- 24: Syscon made a request to move the sled servo to wrong position.
- 30: Tracking balance adjustment error
- 31: Tracking gain adjustment error
- 32: Focus balance adjustment error
- 33: Focus bias adjustment error
- 34: Focus gain adjustment error
- 35: Tilt servo adjustment error
- 36: RF equalizer adjustment error
- 37: RF group delay adjustment error
- 38: Jitter value after adaptive servo operation is too large.
- 40: Focus servo does not operate.
- 41: With a dual layer (DL) disc, focus jump failed.
- 50: CLV (spindle) servo does not operate.
- 51: Spindle does not stop.
- 60: With a DVD disc, Syscon made a request to seek nonexistent address.
- 61: With a CD disc, Syscon made a request to seek nonexistent address.
- 62: With a CD disc, Syscon made a request to seek nonexistent track No. and index No.
- 63: With a DVD disc, seeking of target address failed.
- 64: With a CD disc, seeking of target address failed.
- 65: With a CD disc, seeking of target index failed.
- 70: With a DVD disc, physical information data could not be read.
- 71: With a CD disc, TOC data could not be read.
- 80: Disc type judgment failed.
- 81: As disc type judgment failed, retry was repeated.
- 82: As disc type judgment failed, a measurement error occurred.
- 83: Disc type could not be judged within the specified time.
- 84: Illegal command code was received from Syscon.
- 85: Illegal command was received from Syscon.

6-8. VERSION INFORMATION

```

## Version Information ##
IF con.   Ver : x. xxx (xxxx)
          Group   00

SYScon.   Ver : x. xxx (xxxx)
          Model   xx
          Region  0x
Servo DSP. Ver : 1. xxxx
OPT Type : x LASER

Exit: RETURN
-

```

The ROM version, region code, OPT type, etc. are displayed if **[5]** is selected in the Test Mode Menu.

The parenthesized hexadecimal number in the version number field indicates the checksum value of the ROM.

Note : After down loading ROM data, sometimes it happens that checksum is not the same as that of ROM data which has been down loaded. In such a case, go back to the menu and select "0. Syscon Diagnosis", then select "1. All" in "2. Version". If the result of this operation does not give an agreement, it must be either Down Load error or ROM error.

6-9. VIDEO LEVEL ADJUSTMENT

On the Test Mode Menu screen, selecting **[6]** displays color bars for video level adjustment. During display of color bars, OSD disappears but the menu screen will be restored if pressing any key.

Measurement point : LINE OUT VIDEO
(75 Ω terminating resistance)
Measuring instrument: Oscilloscope
Adjustment device : RV501 on MB-98 board
Specified value : $1.0 \pm_{-0.02}^{+0.04}$ Vp-p

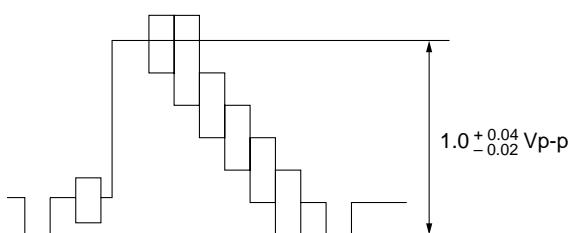

6-10. IF CON SELF DIAGNOSTIC FUNCTION

1. IF-80 BOARD (IF CON) TEST MODE

The front board test mode is the IF CON self diagnostic mode. The IF CON can diagnose the functions of the front panel boards that the IF CON controls. Normally, the IF CON makes a serial communication with the SYSTEM CONTROL and operates following the commands from the SYSTEM CONTROL, but in the Test mode, the IF CON operates independently from the SYSTEM CONTROL.

In the Test mode, the following functions can be checked.

1. Button function
2. Remote commander receiving function
3. SYSTEM CONTROL-IF CON serial communication
4. Click shuttle function
5. Fluorescent display tube lighting check
Grid check
Anode check
6. LED control function

In the Test mode, the set operates same as usual, except voltage monitoring, communication monitoring, display of fluorescent display tube, and LED control.

1. The routine that monitors +3.3 V (P-CONT) of MB-98 board is not provided.
2. The monitoring timer for serial communication with the SYSTEM CONTROL is not provided. The set is not placed in the Standby mode, even if the communication with SYSTEM CONTROL is normal.
3. Display of fluorescent display tube (normally, display is made following the commands from SYSTEM CONTROL)
4. LED control (normally, control is made following the commands from SYSTEM CONTROL)

2. OPERATION OF SELF CHECK MODE

The Self Check mode is the function to conduct the basic test to the FL display and DVD panel section.

2-1. Self Check Mode Transition Processing

At the AC Power ON after IF CON (IC404) was reset, the input to 10pin (SELF CHECK) is judged and if "Low" is entered, the main unit transits to the Self Check mode. In this port input judgment, the result of 3-time attempts must be same (assuming that the MB-98 and AV-56 boards are not connected). While pressing the **[STOP]** key on the main unit with the IF CON in STANDBY mode, enter **[RETURN]** → **[DISPLAY]** (or **[SET UP]**) on the remote commander, and the unit transits to the Self Check Mode. The Self Check mode terminates when the IF CON transits to the STANDBY mode.

2-2. Operation of Auto Self Check

When the Self Check mode becomes active at the AC Power ON or by key input, the test display of the following steps (1) to (4) is repeated.

(1) FLD and LED all ON (for 5 seconds)

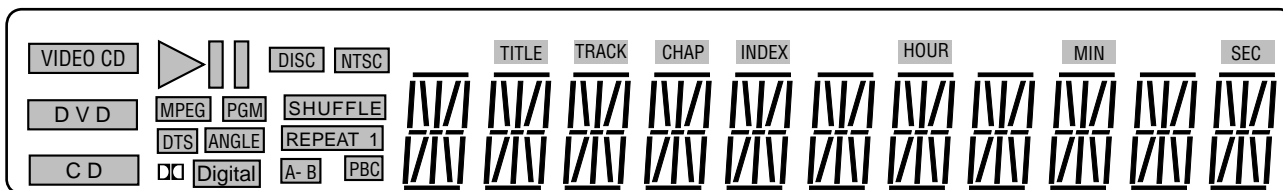

(2) MODEL display (for 2 seconds)

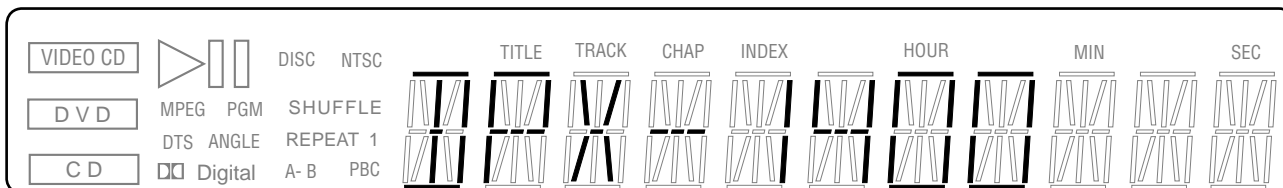

(3) Version display (for 2 seconds)

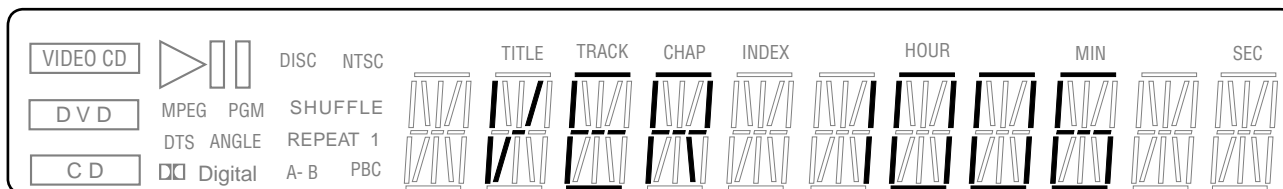

(4) ROM creation date display (for 2 seconds)

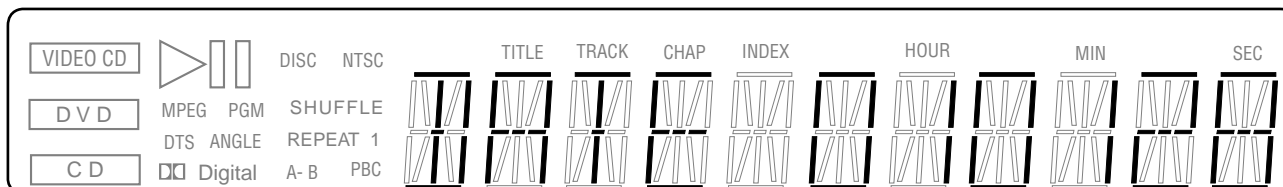

2-3. Each Self Check Function

Each Self Check function tests the FLD display, LED display, and key input.

Input Voltage [V]	IC404: Pin No. (Signal)				
	Pin ③③ (BNRKEY)	Pin ③④ (O/C)	Pin ③⑤ (PLAY)	Pin ③⑥ (DISPLAY)	Pin ③⑦ (CURSOR)
0	SURROUND	OPEN/CLOSE	PLAY	STOP	ENTER
0.70	BNR	PAUSE	–	DISPLAY	DOWN
1.31	–	PREVIOUS	–	DVD MENU	LEFT
1.97	–	NEXT	–	RETURN	UP
2.59	–	–	–	TITLE	RIGHT
3.3	–	–	–	–	–

2-3-1. FLD and LED All ON

2-3-1-1. Transition Keys in Self Check Mode

- **STOP** key and **OPEN/CLOSE** key on the main unit
- **LEFT** key on the main unit and the remote commander

2-3-1-2. Operation and Display

In this mode, all LEDs except STANDBY LED and all segments of FLD turn ON.

Example of FLD all ON

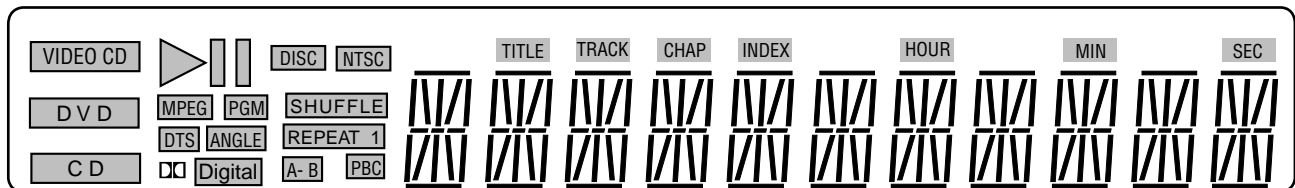

2-3-2. Main Unit Key Name Display and Key Code Display

2-3-2-1. Transition Keys in Self Check Mode

- Keys on main unit except keys transitioned in self check

2-3-2-2. Operation and Display

When a key on the main unit is pressed in the Self Check mode, the name of that key is displayed on the FLD. Also, the key name display and the key code display can be switched with the **DISPLAY** key on the remote commander. “NOTHING” is displayed when nothing is entered. Also, VIDEO CD, DVD, and CD segments turn on when a communication error occurred.

FLD display (at input of **PLAY** key on the main unit)

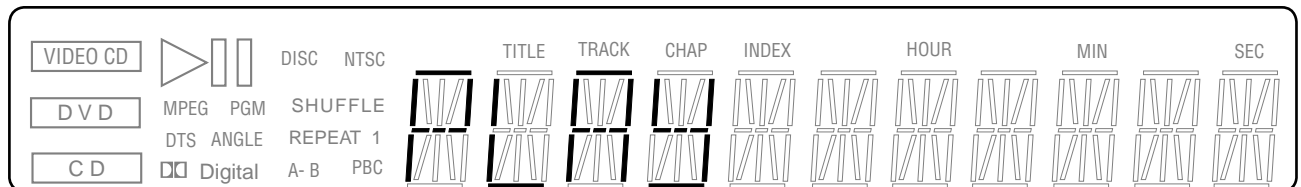

Key code display (at input of **PLAY** key, Key code: 0Ah)

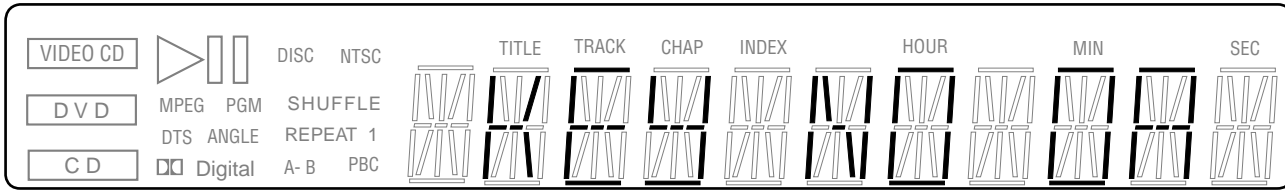

At input of faulty voltage

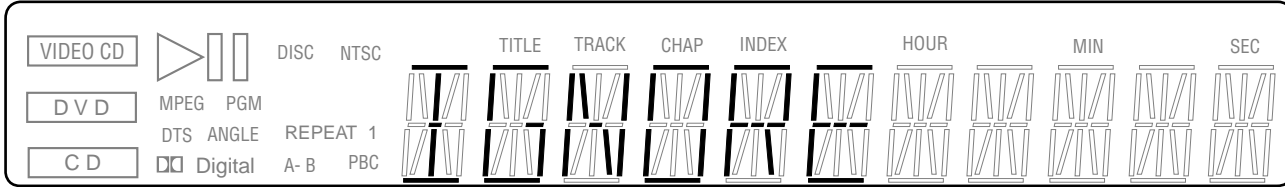

When two keys are pressed

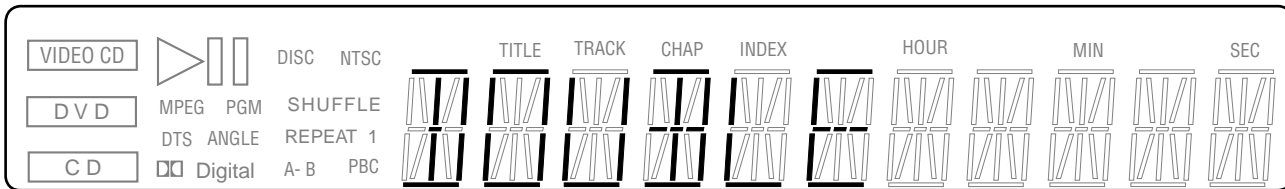

2-3-3. Remote Commander Key Name Display and Key Code Display

2-3-3-1. Transition Keys in Self Check Mode

- Remote commander keys except keys transited in self check

2-3-3-2. Operation and Display

When a key on the remote commander is pressed in the Self Check mode, the name of that key is displayed on the FLD. Also, the key name display and the key code display can be switched with the **DISPLAY** key on the remote commander. "NOTHING" is displayed when nothing is entered. Also, VIDEO CD, DVD, and CD segments turn on when a communication error occurred.

Remote commander key name display (at input of **PAUSE** key)

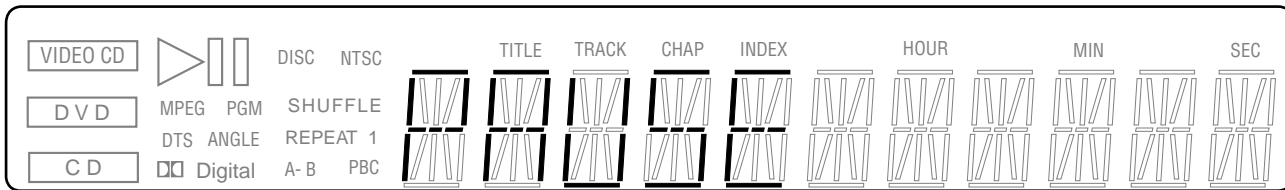

Remote commander key code display (at input of **PAUSE** key, Key code: 39h)

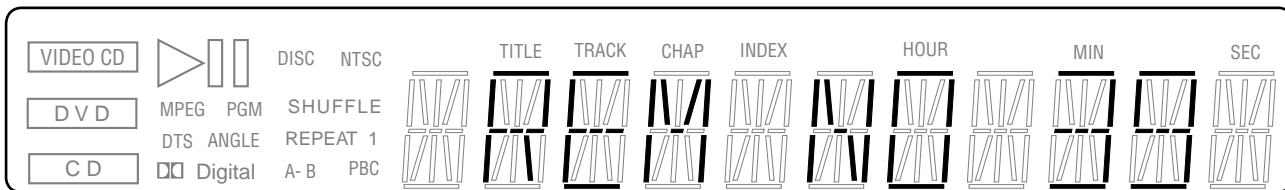

2-3-4. Communication Monitoring Display

The communication state is monitored and displayed while the key name on the main unit and the remote commander is displayed. When the communication to the System Controller failed, VIDEO CD, DVD, and CD segments turn on.

Communication error display (at no key input)

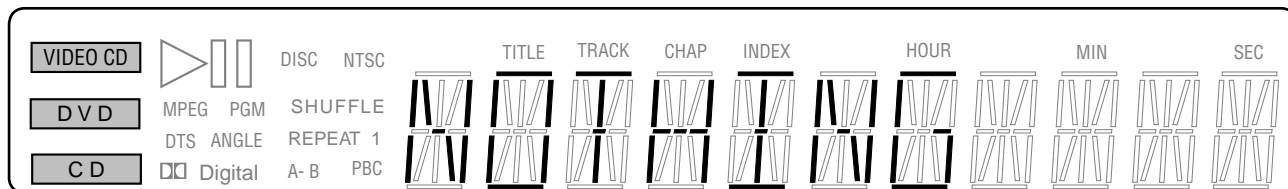

Communication error display (at code display without input of the remote commander)

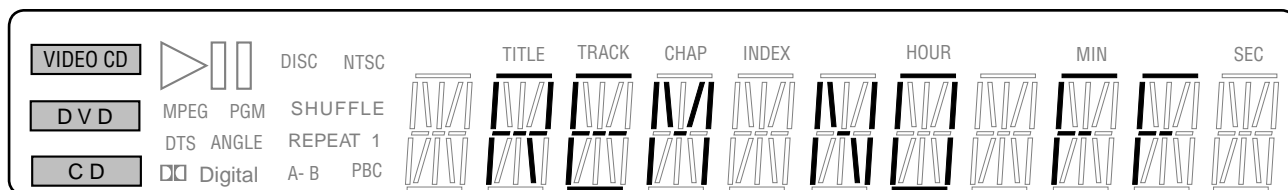

2-3-5. FLD Anode Test Display and SHUTTLE Click Operation Test

2-3-5-1. Transition Keys in Self Check Mode

- [RIGHT] on the main unit and the remote commander
- SHUTTLE on the remote commander during Anode Test display
(This model does not provide JOG/SHUTTLE, and therefore use another DVD remote commander having the JOG/SHUTTLE)

2-3-5-2. Operation and Display

The Self Check mode transits to this mode when [RIGHT] key is entered. Only the first segment of each grid of FLD turns on, and each time the SHUTTLE is entered, the segment of each grid is switched in order. When SHUTTLE input is clockwise, the segment switches in 1 → 2 → 3 direction, or counterclockwise it switches in 3 → 2 → 1 direction. This tests whether each segment turns on individually.

Display at the start of Anode Test

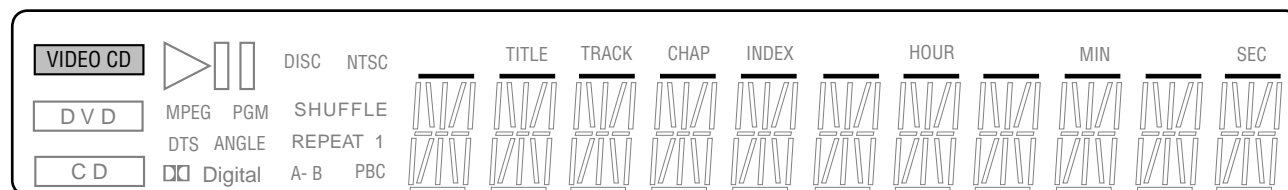

↓ (Input in CW direction)

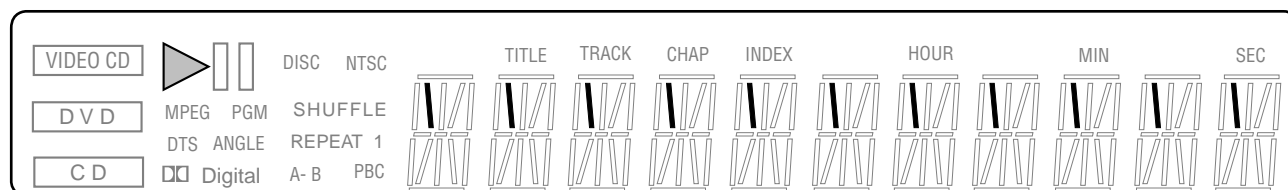

2-3-6. FLD Grid Test Display and SHUTTLE Click Operation Test

2-3-6-1. Transition Keys in Self Check Mode

- [UP] on the main unit and the remote commander
- SHUTTLE on the remote commander during Grid Test display (This model does not provide JOG/SHUTTLE, and therefore use another DVD remote commander having the JOG/SHUTTLE)

2-3-6-2. Operation and Display

The Self Check mode transits to this mode when [UP] key is entered. The first grid of FLD all turns on and other grids turn off. Each time the SHUTTLE is entered, the grid is switched in order. When SHUTTLE input is clockwise, the grid switches in 1 → 2 → 3 direction, or counterclockwise it switches in 3 → 2 → 1 direction. This tests whether each grid turns on individually.

Display at the start of Grid Test

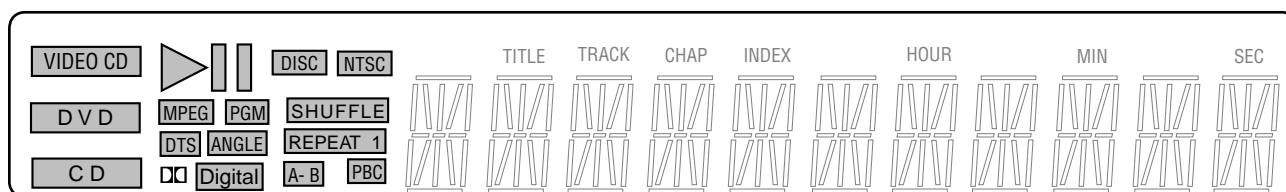

↓ (Input in CW direction)

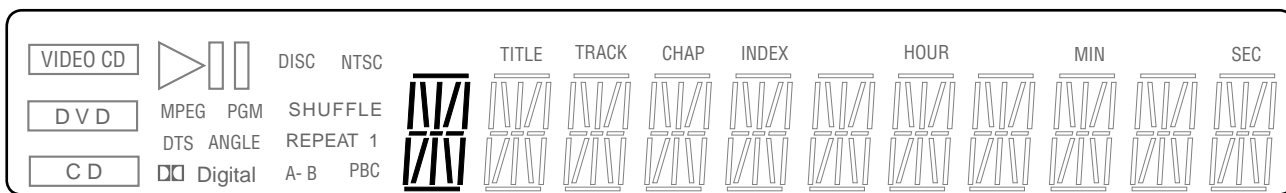

2-3-7. LED Test Display

2-3-7-1. Transition Keys in Self Check Mode

- [DOWN] on the main unit and the remote commander
- SHUTTLE on the remote commander during LED Test display (This model does not provide JOG/SHUTTLE, and therefore use another DVD remote commander having the JOG/SHUTTLE)

2-3-7-2. Operation and Display

LED is switched in order by the input of JOG/SHUTTLE. Also, LED ON/OFF is switched by the input of same key as the function that turns on the LED concerned.

FLD display during LED Test

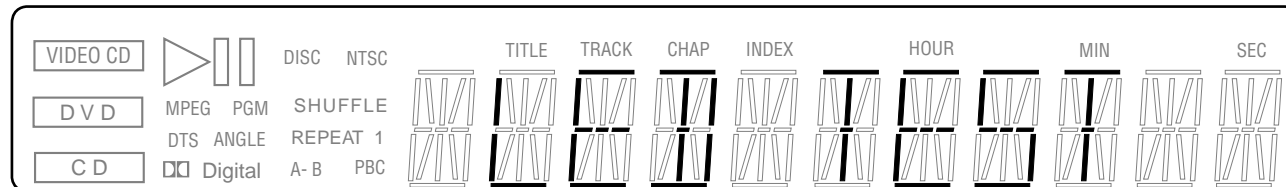

2-3-8. Beep Sound Test

2-3-8-1. Transition Keys in Self Check Mode

- Input of a key on main unit

2-3-8-2. Operation and Display

In the Self Check mode, each time a key on the main unit is entered, a beep sound of 1kHz (100ms) is generated.

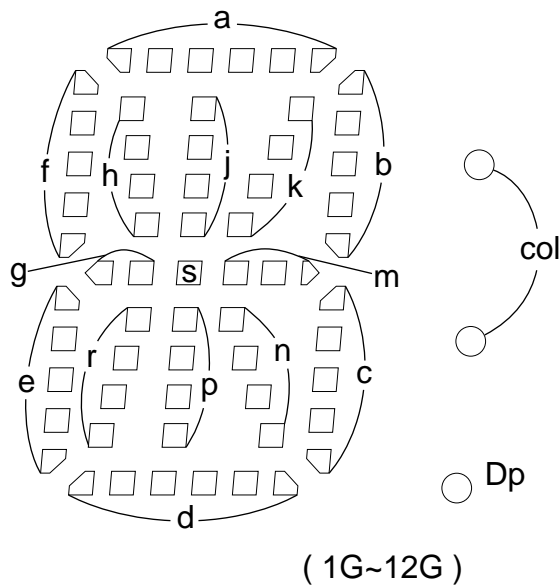
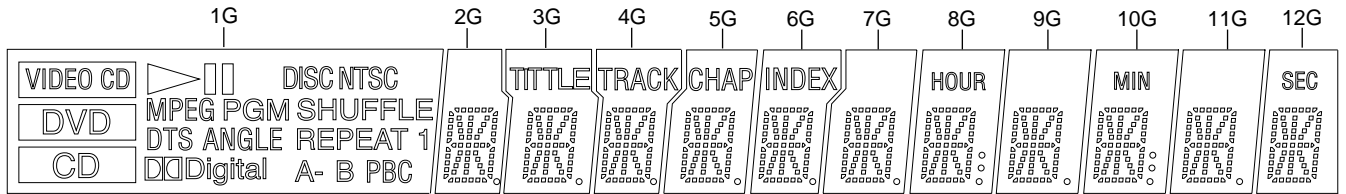

ANODE CONNECTION

	1G	2G	3G	4G	5G	6G	7G	8G	9G	10G	11G	12G
P1	VIDEO CD	a	a	a	a	a	a	a	a	a	a	a
P2	▶	h	h	h	h	h	h	h	h	h	h	h
P3	▯▯	j	j	j	j	j	j	j	j	j	j	j
P4	DISC	k	k	k	k	k	k	k	k	k	k	k
P5	NTSC	b	b	b	b	b	b	b	b	b	b	b
P6	DVD	f	f	f	f	f	f	f	f	f	f	f
P7	MPEG	m	m	m	m	m	m	m	m	m	m	m
P8	PGM	s	s	s	s	s	s	s	s	s	s	s
P9	SHUFFLE	g	g	g	g	g	g	g	g	g	g	g
P10	DTS	e	e	e	e	e	e	e	e	e	e	e
P11	ANGLE	n	n	n	n	n	n	n	n	n	n	n
P12	REPEAT	p	p	p	p	p	p	p	p	p	p	p
P13	1	r	r	r	r	r	r	r	r	r	r	r
P14	PBC	c	c	c	c	c	c	c	c	c	c	c
P15	B	d	d	d	d	d	d	d	d	d	d	d
P16	A-	Dp	Dp	Dp	Dp	Dp	Dp	Dp	Dp	Dp	Dp	-
P17	Digital	-	-	-	-	-	-	col	-	col	-	-
P18	CD	-	TITLE	TRACK	CHAP	INDEX	-	HOUR	-	MIN	-	SEC

6-11. TROUBLESHOOTING

6-11-1. Cannot Enter Test Mode

You cannot enter the Test mode when either button has been pressed by any reason with the board assembled in the front panel. In this state, the power does not turn on even under normal condition (the set is kept in standby state), and also no button is active and the remote commander is not accepted. In this case, disconnect the MB-98 board and AV-56 board, and with the SELF CHECK (⑩ pin) of IF CON (IC404) on the IF-80 board kept in low state, supply AC, and the Test mode will be forcibly activated. Or, on the board, short the land printed as "SELF" to enter the Test mode. The IF CON (IC404) checks the SELF CHECK port only after the power on reset (only at AC supply, not in standby state). If any button is pressed, its name is displayed on the fluorescent display tube. But, if other than "NOTHING" is displayed though no button is pressed, it means that any button has been pressed.

6-11-2. Faults in Test Mode (MB-98 Board)

1. Test mode menu is not displayed

• Board visual check

Check main IC's, SYSTEM CONTROL (IC103), ROM (IC107 or IC108), AVD (IC503), and ARP&SERVO (IC302), for mounting condition, direction, or evidence of short between pins, or soldering failure. Also, compare with good board to check if there are missing capacitors or resistors.

• Clock signal check

Measure the clock frequency at CPUCK (⑦ pin) of the SYSTEM CONTROL (IC103) using an oscilloscope.

If 33 MHz is outputted, an access to the ROM is normal, and then check the items in 1-2.

In the case of 8.25 MHz output, check the items in 1-1.

If it is fixed to "H" or "L", the X101 or SYSTEM CONTROL (IC103) will be faulty.

1-1. CPUCK (33 MHz) is not outputted

• Power supply voltage check

Check the power connectors of the boards or power input pins of the IC's for voltage. Check the IC's in order of SYSTEM CONTROL (IC103), ROM (IC107 or IC108), AVD (IC503), and ARP&SERVO (IC302). If correct voltage is not outputted, the power line will be shorted, or soldering or IC will be faulty.

• Reset signal check

Check that the XFRRST (⑦ pin) of SYSTEM CONTROL (IC103) is "H" (3.3 V). If not "H", a soldering failure of that line, a shot with other line, or faulty SYSTEM CONTROL (IC103) is doubtful.

• XRD, XWRH, and CS0X signals check

Using an oscilloscope, measure the XRD (⑩ pin), XWRH (⑦ pin), and CS0X (⑤ pin) of the SYSTEM CONTROL (IC103) to check if they are fixed to "L" (0 V) or "H" (3.3 V), or if they are on the intermediate potential between "L" and "H". If they are fixed to "L" or "H", or on the intermediate potential, a soldering failure of that line, a shot with other line, or faulty SYSTEM CONTROL (IC103) is doubtful.

• HA [0 - 21] and HD [0 - 15] signals check

Using an oscilloscope, measure the HA [0 - 21] (⑩ - ⑪, ⑫ - ⑬, ⑭ - ⑮, ⑯ - ⑰ pins) and HD [0 - 15] (⑱ - ⑳ pins) of the SYSTEM CONTROL (IC103) to check if they are fixed to "L" (0 V) or "H" (3.3 V), or if HA is on the intermediate potential between "L" and "H" (HD is on intermediate potential in normal state), or if same waveform as that of adjacent pins is measured. In case of "L" or "H", intermediate potential, or same waveform, a soldering failure of that line, a shot with other line, or faulty SYSTEM CONTROL (IC103) is doubtful.

1-2. CPUCK (33 MHz) is outputted (communication with ROM is normal)

• AVD (IC503) check

Using an oscilloscope, measure the SDCLKO (⑭ pin) of the AVD (IC503) to check that 95 MHz is outputted. If not outputted, a short of 27 MHz line across CLKI (⑯ pin) and SCLKIN (⑰ pin), IC mounting failure, or faulty AVD (IC503) is doubtful. If 27 MHz is outputted, the communication between SYSTEM CONTROL (IC103) and AVD (IC503) is disabled, and therefore check the following items, particularly the AVD (IC503).

• WAIT signal check

Using an oscilloscope, measure the XWAIT (⑮ pin) of the SYSTEM CONTROL (IC103) to check if it is fixed to "L" (0 V) or on the intermediate potential. In case of "L" or intermediate potential, examine CS2X - CS5X (⑲ - ⑳ pins) to check if any pin is fixed to "L".

For the CS2X and CS3X, AVD (IC503) mounting failure or faulty IC is doubtful.

For the CS4X and CS5X, ARP&SERVO (IC302) mounting failure or faulty IC is doubtful.

If CS2X - CS5X are not "L", or they are sometimes on intermediate potential, a soldering failure of XWAIT line, a short with other line, or faulty SYSTEM CONTROL (IC103) is doubtful.

• INT signal check

Using an oscilloscope, measure the INT0 - 2, 4 - 6 (⑳ - ㉑ pins, ㉒ - ㉓ pins) of the SYSTEM CONTROL (IC103) to check if INT0 - 2, and 6 are fixed to "L" (0 V) and INT5 is fixed to "H" (3.3 V), or they are on intermediate potential. In case of "L", "H", or intermediate potential, a soldering failure of IC's connected to that line, a short with other line, faulty SYSTEM CONTROL (IC103), or faulty each IC is doubtful.

INT0 : AVD (IC503)

INT1, INT2 : ARP&SERVO (IC302)

INT5, INT6 : AUDIO DSP (IC701)

• CSnX signals check

Using an oscilloscope, measure the CX0X - CX7X (㉔ - ㉕, ㉖, ㉗ pins) of the SYSTEM CONTROL (IC103) to check if they are fixed to "L" (0 V), or two or more CS's sometime go "L", or on intermediate potential. In case of fixed "L", two or more CS's on "L" or intermediate potential, a soldering failure of IC's connected to that line, a short with other line, faulty SYSTEM CONTROL (IC103), or faulty each IC is doubtful.

CS0X : ROM (IC107 or IC108)

CS2X, CS3X : AVD (IC503)

CS4X, CS5X : ARP&SERVO (IC302)

• Other CS signals check

Using an oscilloscope, measure the VESCS/X39CS (㉘ pin) and XDACS (㉙ pin) of the SYSTEM CONTROL (IC103) to check if they are fixed to "L". If fixed, a soldering failure of that line, a short with other line, or faulty SYSTEM CONTROL (IC103) is doubtful.

If the above checking could not find a fault, check the outputted CS signal. If CS signal other than CS0X is outputted, a mounting failure of each IC or faulty IC that corresponds to active CS signal is doubtful.

CS2X, CS3X : AVD (IC503)

CS4X, CS5X : ARP&SERVO (IC302)

2. Test mode menu is displayed, but operation stops when a menu is selected

Using an oscilloscope, measure the PLCKO (㉚ pin) of the ARP&SERVO (IC302) to check if it is fixed to "L" (0 V) or "H" (3.3 V). If fixed to "L" or "H", the ARP&SERVO (IC302) is faulty. If not fixed, check the items in 1-2. in order.

3. Specific item failed in Diag All Check

A mounting failure of IC or faulty IC for that item is doubtful. If “1901NG” is displayed, a loose connection of CN801, mounting failure of AUDIO DSP (IC701), or faulty IC is doubtful.

4. Picture and sound are not outputted

Check the CN801 for connection, and the flat cable for damage or loose connection.

5. Picture is outputted, but sound is not outputted

A mounting failure of AUDIO DSP (IC801) or AUDIO DAC (IC802, IC803), power supply failure, or faulty IC is doubtful.

6. Sound is outputted, but picture is not outputted

Using an oscilloscope, measure the ⑥③, ⑥⑥, ⑥⑨, ⑦④, ⑦⑦, and ⑧① pins of AVD (IC503) to check if analog signals are outputted respectively. If not outputted, a soldering failure of that line, a short with other line, missing capacitor or resistor, or faulty AVD is doubtful.

6-11-3. Drive Auto Adjustment stops by an error

Faulty analog circuits of ARP&SERVO (IC302) or faulty peripheral circuits of DIGITAL SERVO (IC202) on the MB-98 board, faulty optical pickup, or loose connection of flat cable is doubtful.

6-11-4. Power is Supplied but Unstable

If Syscon Diagnosis completed successfully, basically the boards other than MB-98 board, connection, optical pickup, or mechanical deck will be faulty.

1. Red LED does not light when AC is supplied

Check if the specified voltage is outputted from the EVER –11 V (③ pin), EVER +3.3 V (⑪ pin), and EVER +11 V (⑬ pin) of CN201 or CN920 in the power supply block. If not outputted, the power supply block will be faulty.

2. At [POWER] button ON, LED does not light in green even once, but kept in red (standby state)

Check if the specified voltage is outputted from the EVER –11 V (③ pin), EVER +3.3 V (⑪ pin), and EVER +11 V (⑬ pin) of CN201 or CN920 in the power supply block. If not outputted, the power supply block will be faulty.

Check the P-CONT (② pin) of CN401 on the IF-80 board if it becomes “H”. If not “H”, a soldering failure of that line, a short with other line, missing capacitor or resistor, faulty AVD (IC503), loose connection between power supply block and IF-80 board, loose connection of connectors, faulty power supply block, or faulty IF-80 board is doubtful.

3. At [POWER] button ON, LED lights in green but returns to red (standby state) after several seconds (e.g. it returns to standby state after “SONY DVD” was displayed)

There is no regularity between faulty parts and timing when the set returns to the standby state).

Check if the specified voltage is outputted from the power supply block. If not outputted, the power supply block will be faulty.

Check the XFRRST (⑨ pin) of CN101 on the MB-98 board if it is fixed to “L”, or the XIBUSY (⑩ pin), XIFCS (⑪ pin), SIO (⑫ pin), SOO (⑬ pin) and SC0 (⑭ pin) of CN101 if they are fixed to “L” or “H”.

If fixed to “L” or “H”, a soldering failure of that line, a short with other line, missing capacitor or resistor, or faulty AVD (IC503) is doubtful.

If not fixed to “L” or “H”, loose connection between power supply block and IF-80 board or between IF-80 board and MB-98 board, loose connection of connectors, or faulty IF-80 board is doubtful.

4. At [POWER] button ON, LED lights in green but fluorescent display tube does not light

Loose connection between power supply block and IF-80 board, loose connection of connectors, or faulty IF-80board is doubtful.

5. Picture and sound are not outputted

Loose connection between power supply block and IF-80 board or between IF-80 and AV-56 board or between AV-56 board and MB-98 board, loose connection of connectors, or faulty AV-56 board is doubtful.

6. Picture is out outputted correctly

A mounting failure of BNR (IC601) on the MB-98 board, or faulty AVD (IC503) or ARP&SERVO (IC302), or faulty 27 MHz output (frequency, waveform) from 27-1OUT (③ pin) of PLL (IC102) is doubtful.

6-11-5. Power is not Supplied

1. Red LED does not light when AC is supplied

The power (EVER +3.3 V) is not supplied to the IF CON (IC404) on the IF-80 board.

The X401 does not oscillate.

2. At [POWER] button ON, LED is kept in red (standby state)

Any button has been pressed.

The voltage at PONCHK (⑩ pin) of the IF CON (IC404) on the IF-80 board exceeds 0.5 V.

3. At [POWER] button ON, LED lights in green but returns to red (standby state) after several seconds

The PONCHK (⑩ pin) of the IF CON (IC404) on the IF-80 board is abnormal (slow rising from 0.5 V to more than 1.5 V, or voltage not rising to more than 1.5 V).

The SYSTEM CONTROL (IC103) on the MB-98 board is faulty.

SECTION 7 ELECTRICAL ADJUSTMENT

In making adjustment, refer to 7-3. Adjustment Related Parts Arrangement.

Note: During diagnostic check, the characters and color bars can be seen only with the NTSC monitor. Therefore, for diagnostic check, use the monitor that supports both NTSC and PAL modes.

Use the reference disc for PAL for check, and use the reference disc for NTSC for adjustment.

This section describes procedures and instructions necessary for adjusting electrical circuits in this set.

Instruments required:

- 1) Color monitor TV
- 2) Oscilloscope 1 or 2 phenomena, band width over 100 MHz, with delay mode
- 3) Frequency counter (over 8 digits)
- 4) Digital voltmeter
- 5) Standard commander (RMT-D126A/D126E/D126P)
- 6) DVD reference disc
 - HLX-501 (J-6090-071-A) (dual layer) (NTSC)
 - HLX-503 (J-6090-069-A) (single layer) (NTSC)
 - HLX-504 (J-6090-088-A) (single layer) (NTSC)
 - HLX-505 (J-6090-089-A) (dual layer) (NTSC)
 - HLX-506 (J-6090-077-A) (single layer) (PAL)
 - HLX-507 (J-6090-078-A)(dual layer) (PAL)
- 7) SACD reference disc
 - HLXA-509 (J-6090-090-A)
- 8) Extention Cable (J-6090-107-A)

Abbreviation:

RUS : Russian

7-1. POWER SUPPLY CHECK

1. HS13S0E/HS13S0F/HS13S0U/TOP-244U Boards

Mode	E-E
Instrument	Digital voltmeter
EVER +3.3 V Check	
Test point	CN201 pin ⑪
Specification	3.5 ± 0.2 Vdc
SW +3.3 V Check	
Test point	CN201 pin ⑧
Specification	3.3 ± 0.2 Vdc
+5 V Check	
Test point	CN201 pin ⑫
Specification	5.0 ± 0.3 Vdc
SW +11 V Check	
Test point	CN201 pin ⑥, ⑦
Specification	$11.5^{+1.0}_{-1.5}$ Vdc
EVER +11 V Check	
Test point	CN201 pin ⑬
Specification	11.0 ± 1.0 Vdc
EVER -11 V Check	
Test point	CN201 pin ③
Specification	-11.0 ± 1.0 Vdc

Checking method:

- 1) Confirm that each voltage satisfies the specification.

7-2. ADJUSTMENT OF VIDEO SYSTEM

1. Video Level Adjustment (MB-98 BOARD)

<Purpose>

This adjustment is made to satisfy the NTSC/PAL standard, and if not adjusted correctly, the brightness will be too large or small.

Mode	Video level adjustment in test mode
Signal	Color bars
Test point	LINE OUT (VIDEO) connector (75 Ω terminated)
Instrument	Oscilloscope
Adjusting element	RV501
Specification	$1.0 \begin{smallmatrix} +0.04 \\ -0.02 \end{smallmatrix}$ Vp-p

Adjusting method:

- 1) In the test mode initial menu "6" Video Level Adjustment, set so that color bars are generated.
- 2) Adjust the RV501 to attain $1.0 \begin{smallmatrix} +0.04 \\ -0.02 \end{smallmatrix}$ Vp-p.



Figure 7-1

2. Checking S Video Output S-Y

<Purpose>

Check S-terminal video output. If it is incorrect, pictures will not be displayed correctly in spite of connection to the TV with a S-terminal cable.

Mode	Video level adjustment in test mode
Signal	Color bars
Test point	S VIDEO OUT (S-Y) connector (75 Ω terminated)
Instrument	Oscilloscope
Specification	1.0 ± 0.05 Vp-p

Checking method:

- 1) In the test mode initial menu "6" Video Level Adjustment, set so that color bars are generated.
- 2) Confirm that the S-Y level is 1.0 ± 0.05 Vp-p.



Figure 7-2

3. Checking S Video Output S-C

<Purpose>

This checks whether the S-C satisfies the NTSC/PAL Standard. If it is not correct, the colors will be too dark or light.

Mode	Video level adjustment in test mode
Signal	Color bars
Test point	S VIDEO OUT (S-C) connector (75 Ω terminated)
Instrument	Oscilloscope
Specification	A = 286 ± 30 mVp-p (NTSC) A = 300 ± 100 mVp-p (PAL)

Checking method:

- 1) In the test mode initial menu "6" Video Level Adjustment, set so that color bars are generated.
- 2) Confirm that the S-C burst is "A".

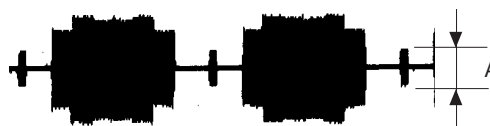

Figure 7-3

4. Checking Component Video Output Y (Except AEP, UK, RUS Model)

<Purpose>

This checks component video output Y. If it is incorrect, correct brightness will not be attained when connected to, for instance, projector.

Mode	Video level adjustment in test mode
Signal	Color bars
Test point	COMPONENT VIDEO OUT (Y) connector (75 Ω terminated)
Instrument	Oscilloscope
Specification	1.0 ± 0.05 Vp-p

Checking method:

- 1) In the test mode initial menu "6" Video Level Adjustment, set so that color bars are generated.
- 2) Confirm that the Y level is 1.0 ± 0.05 Vp-p.

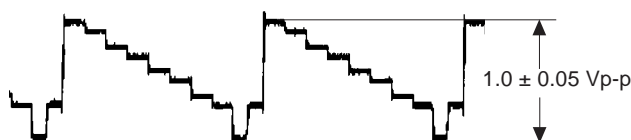

Figure 7-4

5. Checking Component Video Output B-Y (Except AEP, UK, RUS Model)

<Purpose>

This checks component video output B-Y. If it is incorrect, correct colors will not be displayed when connected to, for instance, projector.

Mode	Video level adjustment in test mode
Signal	Color bars
Test point	COMPONENT VIDEO OUT (P _B) connector (75 Ω terminated)
Instrument	Oscilloscope
Specification	700 ± 50 mVp-p

Checking method:

- 1) In the test mode initial menu “6” Video Level Adjustment, set so that color bars are generated.
- 2) Confirm that the B-Y level is 700 ± 50 mVp-p.

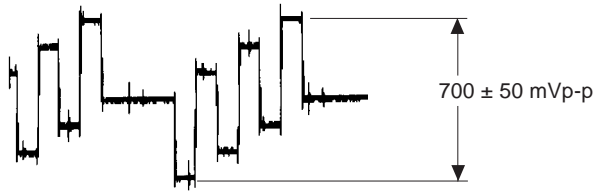

Figure 7-5

6. Checking Component Video Output R-Y (Except AEP, UK, RUS Model)

<Purpose>

This checks component video output R-Y. If it is incorrect, correct colors will not be displayed when connected to, for instance, projector.

Mode	Video level adjustment in test mode
Signal	Color bars
Test point	COMPONENT VIDEO OUT (P _R) connector (75 Ω terminated)
Instrument	Oscilloscope
Specification	700 ± 50 mVp-p

Checking method:

- 1) In the test mode initial menu “6” Video Level Adjustment, set so that color bars are generated.
- 2) Confirm that the R-Y level is 700 ± 50 mVp-p.

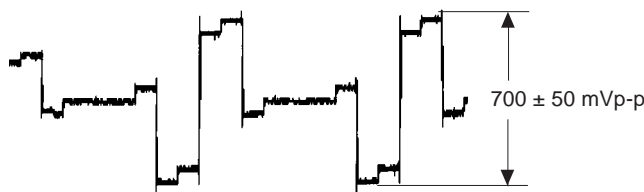

Figure 7-6

7. Checking RGB Output R (AEP, UK, RUS Model)

<Purpose>

This checks RGB output R. If it is incorrect, pictures will not be displayed correctly in spite of connection to the TV with an EURO AV connecting cord.

Mode	In test mode, Push [0] for Syscon Diagnosis and push [7] for Video and push [5] for RGB out
Signal	Color bars
Test point	LINE 1 (RGB)-TV connector pin ⑮ (75 Ω terminated)
Instrument	Oscilloscope
Specification	700 ± 50 mVp-p

Checking method:

- 1) Confirm that the R level is 700 ± 50 mVp-p.

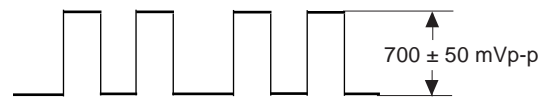

Figure 7-7

8. Checking RGB Output G (AEP, UK, RUS Model)

<Purpose>

This checks RGB output G. If it is incorrect, pictures will not be displayed correctly in spite of connection to the TV with an EURO AV connecting cord.

Mode	In test mode, Push [0] for Syscon Diagnosis and push [7] for Video and push [5] for RGB out
Signal	Color bars
Test point	LINE 1 (RGB)-TV connector pin ⑰ (75 Ω terminated)
Instrument	Oscilloscope
Specification	700 ± 50 mVp-p

Checking method:

- 1) Confirm that the G level is 700 ± 50 mVp-p.

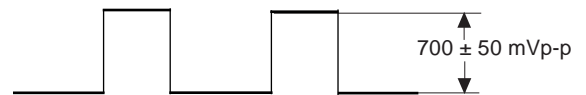

Figure 7-8

9. Checking RGB Output B (AEP, UK, RUS Model)

<Purpose>

This checks RGB output B. If it is incorrect, pictures will not be displayed correctly in spite of connection to the TV with an EURO AV connecting cord.

Mode	In test mode, Push [0] for Syscon Diagnosis and push [7] for Video and push [5] for RGB out
Signal	Color bars
Test point	LINE 1 (RGB)-TV connector pin ⑦ (75 Ω terminated)
Instrument	Oscilloscope
Specification	700 ± 50 mVp-p

Checking method:

- 1) Confirm that the B level is 700 ± 50 mVp-p.

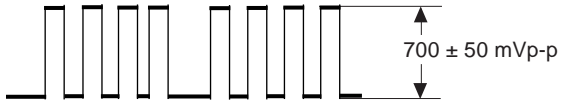
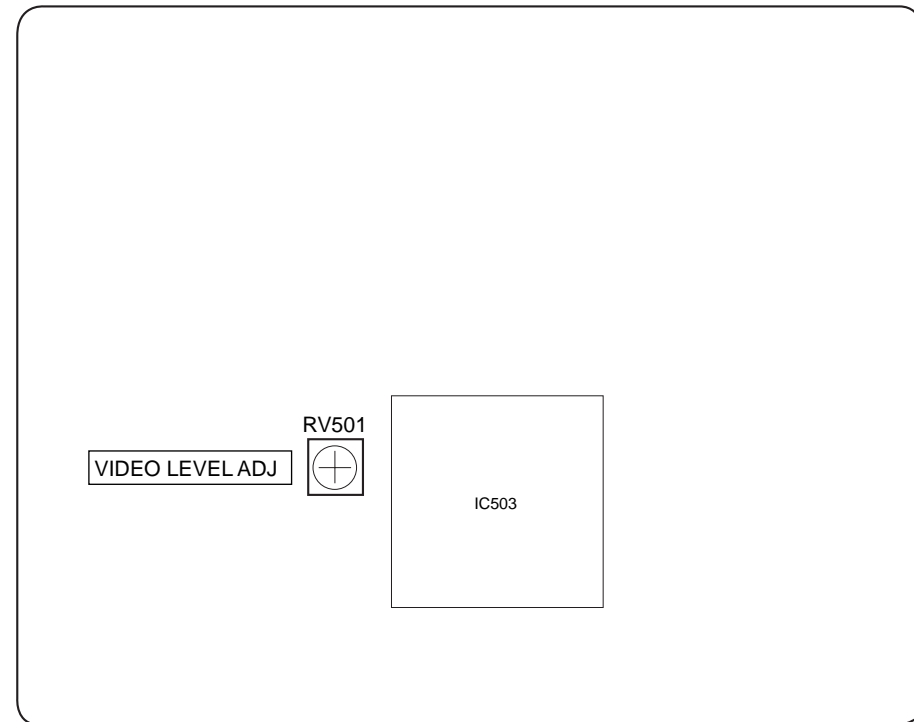

Figure 7-9

7-3. ADJUSTMENT RELATED PARTS ARRANGEMENT

MB-98 BOARD (SIDE A)



HS13S0E/HS13S0F/HS13S0U/TOP-244U BOARDS (SIDE A)

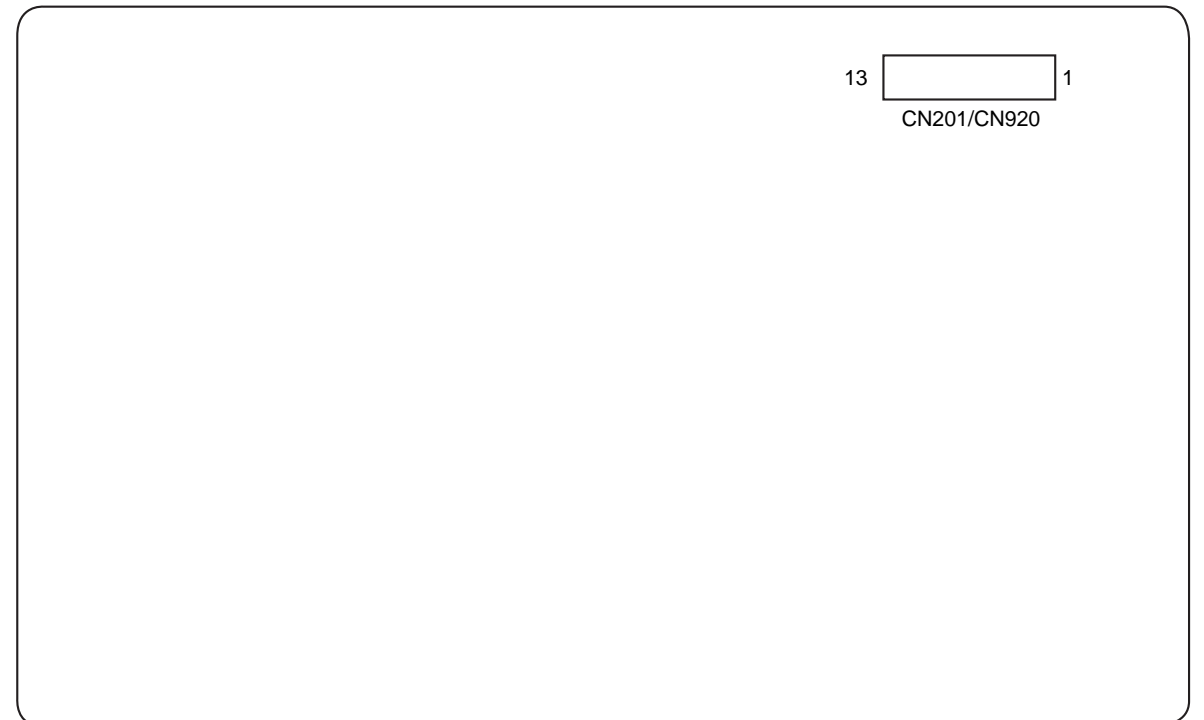

**SECTION 8
REPAIR PARTS LIST**

8-1. EXPLODED VIEWS

NOTE:

- XX and -X mean standardized parts, so they may have some difference from the original one.
- Items marked "*" are not stocked since they are seldom required for routine service. Some delay should be anticipated when ordering these items.
- Abbreviation
 - AR : Argentina model
 - AUS : Australian model
 - BR : Brazilian model
 - CND : Canadian model
 - E12 : 220-240 V AC Area in E model
 - E32 : 110-240 V AC Area in E model
 - EA : Saudi Arabia model
 - HK : Hong Kong model
 - KR : Korea model
 - ME : Middle East model
 - RUS : Russian model
 - SP : Singapore model
 - TW : Taiwan model
- The mechanical parts with no reference number in the exploded views are not supplied.
- Hardware (# mark) list and accessories and packing materials are given in the last of the electrical parts list.

The components identified by mark Δ or dotted line with mark Δ are critical for safety. Replace only with part number specified.

Les composants identifiés par une marque Δ sont critiques pour la sécurité. Ne les remplacer que par une pièce portant le numéro spécifié.

Description about model name

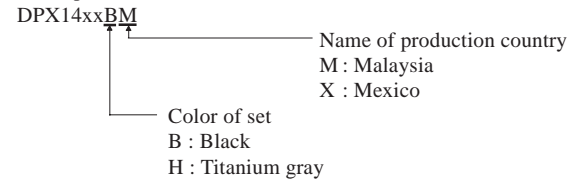

8-1-1. CASE ASSEMBLY

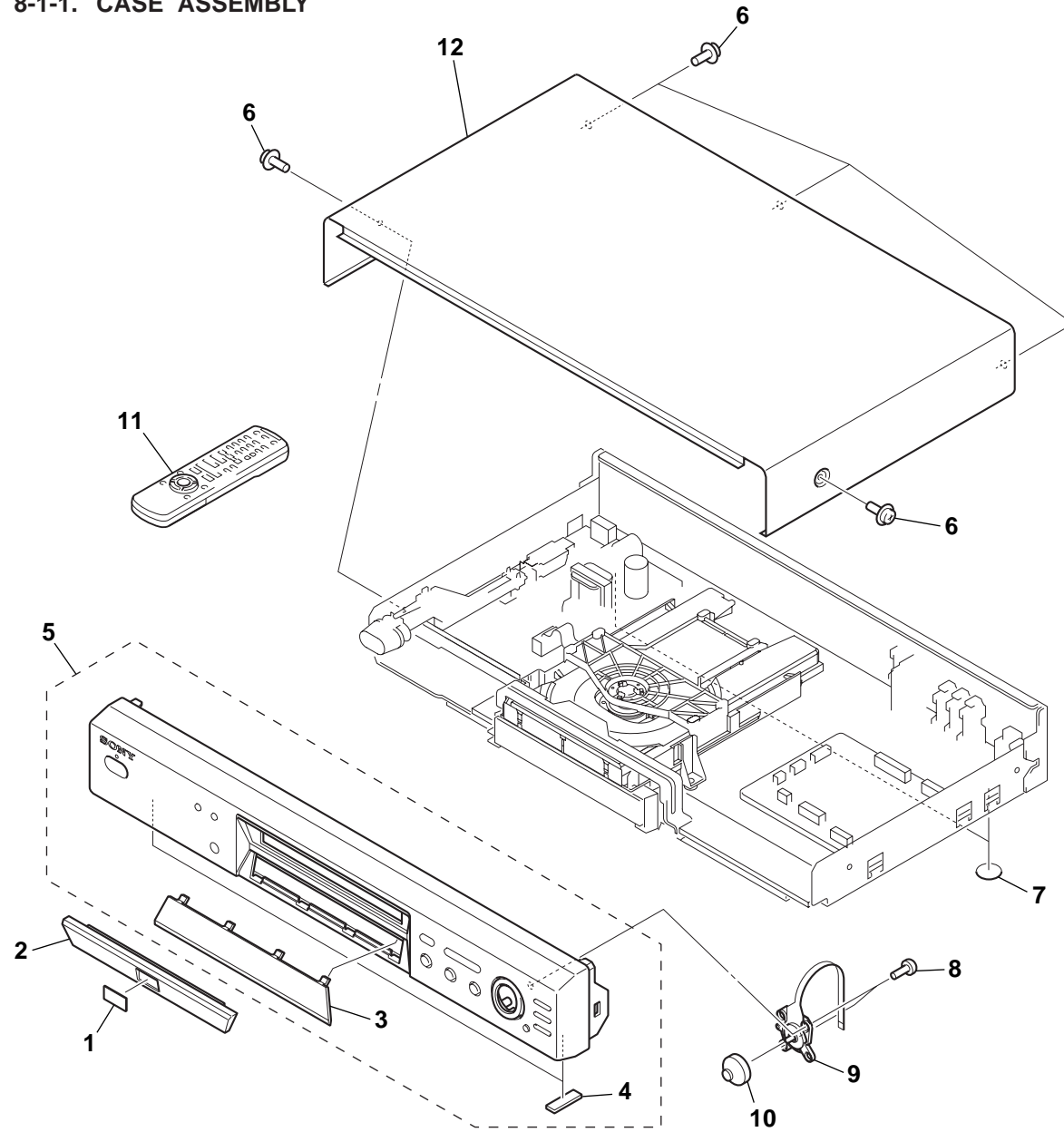

Ref. No.	Part No.	Description	Remark	Ref. No.	Part No.	Description	Remark
1	3-067-237-01	EMBLEM (V), DVD (US (DPX1400BM), US (DPX1400BX), CND (DPX1400BM), AEP (DPX1401BM), AEP (DPX1402BM), UK (DPX1401BM), PX)		6	3-710-901-61	SCREW, TAPPING (EXCEPT US (DPX1400BM), US (DPX1400BX), CND (DPX1400BM), AEP (DPX1401BM), AEP (DPX1402BM), UK (DPX1401BM), PX)	
1	3-067-237-11	EMBLEM (V), DVD (EXCEPT US (DPX1400BM), US (DPX1400BX), CND (DPX1400BM), AEP (DPX1401BM), AEP (DPX1402BM), UK (DPX1401BM), PX)		7	3-068-890-01	CUSHION, REAR LEG	
2	3-067-234-01	COVER (S), TRAY (US (DPX1400BM), US (DPX1400BX), CND (DPX1400BM), AEP (DPX1401BM), AEP (DPX1402BM), UK (DPX1401BM), PX)		8	3-970-608-51	SUMITITE (B3), +BV	
2	3-067-234-11	COVER (S), TRAY (EXCEPT US (DPX1400BM), US (DPX1400BX), CND (DPX1400BM), AEP (DPX1401BM), AEP (DPX1402BM), UK (DPX1401BM), PX)		9	1-786-131-11	SWITCH, TACTILE	
3	3-067-225-01	WINDOW		10	3-067-238-11	CURSOR STICK (US (DPX1400BM), US (DPX1400BX), CND (DPX1400BM), AEP (DPX1401BM), AEP (DPX1402BM), UK (DPX1401BM), PX)	
4	3-059-349-11	CUSHION, FOOT		10	3-067-238-21	CURSOR STICK (US (DPX1400HM), CND (DPX1400HM), AEP (DPX1401HM), AEP (DPX1402HM), UK (DPX1401HM), RUS, E12, E32, EA, ME, AR, MX (DPX1400HM), BR, HK, KR, SP, TW, AUS)	
5	A-6062-596-A	FRONT PANEL ASSY (BR)		11	1-476-602-11	REMOTE COMMANDER (RMT-D126A) (US, CND, E32, MX, AR, BR, PX)	
5	X-3951-477-1	FRONT PANEL ASSY (US (DPX1400BM), US (DPX1400BX), CND (DPX1400BM), PX)		11	1-476-603-11	REMOTE COMMANDER (RMT-D126P) (AEP, UK, RUS)	
5	X-3951-478-1	FRONT PANEL (C) ASSY (US (DPX1400HM), CND (DPX1400HM), AEP (DPX1401HM), AEP (DPX1402HM), UK (DPX1401HM), RUS, E12, E32, EA, ME, MX, AR, HK, KR, SP, TW, AUS)		11	1-476-603-31	REMOTE COMMANDER (RMT-D126E) (E12, EA, ME, HK, KR, SP, TW, AUS)	
5	X-3951-512-1	FRONT PANEL ASSY (AEP (DPX1401BM), AEP (DPX1402BM), UK (DPX1401BM))		12	3-068-047-11	CASE (US (DPX1400HM), CND (DPX1400HM), AEP (DPX1401HM), AEP (DPX1402HM), UK (DPX1401HM), RUS, E12, E32, AR, EA, ME, HK, MX, BR, KR, SP, TW, AUS)	
6	3-710-901-11	SCREW, TAPPING (US (DPX1400BM), US (DPX1400BX), CND (DPX1400BM), AEP (DPX1401BM), AEP (DPX1402BM), UK (DPX1401BM), PX)		12	3-068-047-01	CASE (US (DPX1400BM), US (DPX1400BX), CND (DPX1400BM), AEP (DPX1401BM), AEP (DPX1402BM), UK (DPX1401BM), PX)	

8-1-2. CHASSIS ASSEMBLY

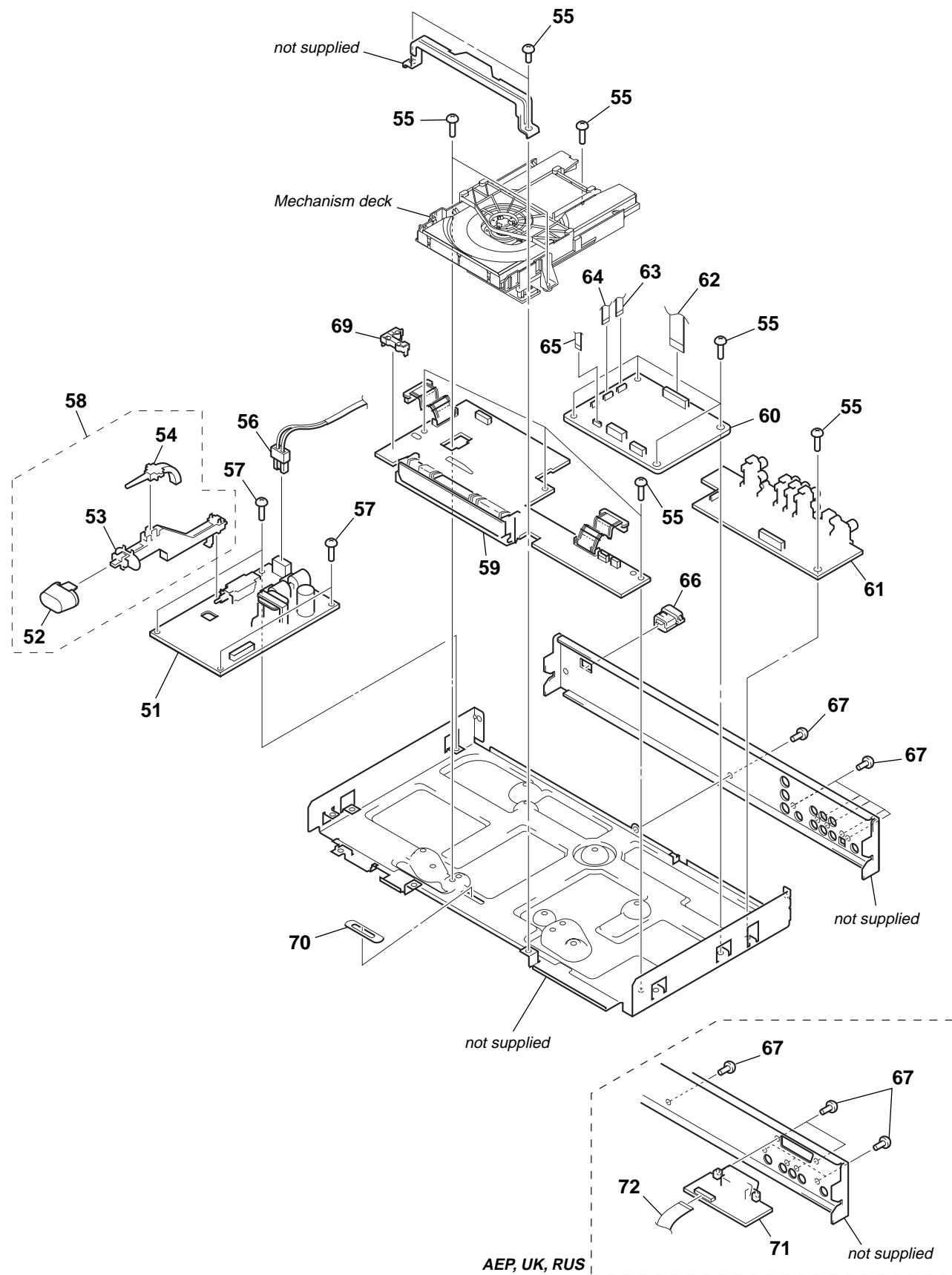

Ref. No.	Part No.	Description	Remark	Ref. No.	Part No.	Description	Remark
* 51	1-468-583-11	POWER BLOCK (HS13SOU)	(US, CND, MX, TW)	* 60	A-6065-646-A	MB-98 BOARD, COMPLETE	(AEP (DPX1401BM), AEP (DPX1401HM), UK)
* 51	1-468-584-11	POWER BLOCK (TOP-244U)	(US, CND, MX)	* 60	A-6065-650-A	MB-98 BOARD, COMPLETE	(US (DPX1400BM), US (DPX1400HM), CND, PX)
* 51	1-468-585-11	POWER BLOCK (HS13S0E)	(AEP, UK, RUS, E12, EA, ME, AR, HK, KR, SP, AUS)	* 60	A-6065-654-A	MB-98 BOARD, COMPLETE	(AEP (DPX1402BM), AEP (DPX1402HM))
* 51	1-468-586-11	POWER BLOCK (HS13S0F)	(E32, BR, PX)	* 60	A-6065-655-A	MB-98 BOARD, COMPLETE	(E32, MX (DPX1400HM), AR, BR)
52	3-067-232-11	BUTTON (POWER)	(US (DPX1400BM), US (DPX1400BX), CND (DPX1400BM), AEP (DPX1401BM), AEP (DPX1402BM), UK (DPX1401BM), PX)	* 60	A-6065-656-A	MB-98 BOARD, COMPLETE (RUS)	
52	3-067-232-21	BUTTON (POWER)	(US (DPX1400HM), CND (DPX1400HM), AEP (DPX1401HM), AEP (DPX1402HM), UK (DPX1401HM), RUS, E12, E32, EA, ME, MX (1400HM), AR, BR, HK, KR, SP, TW, AUS)	* 60	A-6065-657-A	MB-98 BOARD, COMPLETE (E12)	
53	3-067-233-11	JOINT (POWER)		* 60	A-6065-658-A	MB-98 BOARD, COMPLETE (EA, ME)	
54	3-059-321-11	INDICATOR (P)		* 60	A-6065-659-A	MB-98 BOARD, COMPLETE (AUS)	
55	3-970-608-11	SUMITITE (B3), +BV		* 60	A-6065-660-A	MB-98 BOARD, COMPLETE (HK, KR, SP, TW)	
△ 56	1-757-901-11	CORD, POWER (AR)		* 60	A-6065-661-A	MB-98 BOARD, COMPLETE (US (DPX1400BX))	
△ 56	1-769-744-91	CORD, POWER (AEP, UK, RUS, E12, E32, EA, ME, BR, HK, SP, PX)		* 60	A-6065-672-A	MB-98 BOARD, COMPLETE	(MX (DPX1400HX))
△ 56	1-782-752-31	CORD, POWER (KR)		* 61	A-6065-645-A	AV-56 BOARD, COMPLETE (AEP, UK, RUS)	
△ 56	1-783-532-31	CORD, POWER (US, CND, MX)		* 61	A-6065-649-A	AV-56 BOARD, COMPLETE	(E12, EA, ME, HK, KR, SP, TW, AUS)
△ 56	1-790-390-41	CORD, POWER (TW)		* 61	A-6065-662-A	AV-56 BOARD, COMPLETE	(US (DPX1400BX), MX (DPX1400HX))
△ 56	1-790-588-11	CORD, POWER (AUS)		* 61	A-6065-702-A	AV-56 BOARD, COMPLETE	(US (DPX1400BM), US (DPX1400HM), CND, E32, MX (DPX1400HM), AR, BR, PX)
57	3-050-569-01	SUMITITE (B3), +WHD		62	1-757-695-11	CABLE, FLEXIBLE FLAT (FMA-023)	
58	X-3951-592-1	BUTTON ASSY, POWER (MX (DPX1400HX))		63	1-757-693-11	CABLE, FLEXIBLE FLAT (FMO-001)	
* 59	A-6064-706-A	IF-80 BOARD, COMPLETE (BR)		64	1-757-694-11	CABLE, FLEXIBLE FLAT (FMO-002)	
* 59	A-6065-647-A	IF-80 BOARD, COMPLETE (AEP, UK, RUS)		65	1-757-697-11	CABLE, FLEXIBLE FLAT (FMM-035)	
* 59	A-6065-651-A	IF-80 BOARD, COMPLETE (US (DPX1400BM), US (DPX1400HM), CND, E12, E32, EA, ME, MX (DPX1400HM), AR, HK, KR, SP, TW, AUS, PX)		66	4-966-267-12	BUSHING (FBS001), CORD	
* 59	A-6065-663-A	IF-80 BOARD, COMPLETE (US (DPX1400BX), MX (DPX1400HX))		67	3-970-608-51	SUMITITE (B3), +BV	
				69	3-067-248-01	LED HOLDER	
				70	3-069-090-01	COVER, EJECT	
				71	A-6065-648-A	ER-14 BOARD, COMPLETE (AEP, UK, RUS)	
				72	1-757-699-11	CABLE, FLEXIBLE FLAT (FAE-005)	(AEP, UK, RUS)

The components identified by mark \triangle or dotted line with mark \triangle are critical for safety. Replace only with part number specified.	Les composants identifiés par une marque \triangle sont critiques pour la sécurité. Ne les remplacer que par une pièce portant le numéro spécifié.
--	--

8-1-3. MECHANISM DECK ASSEMBLY

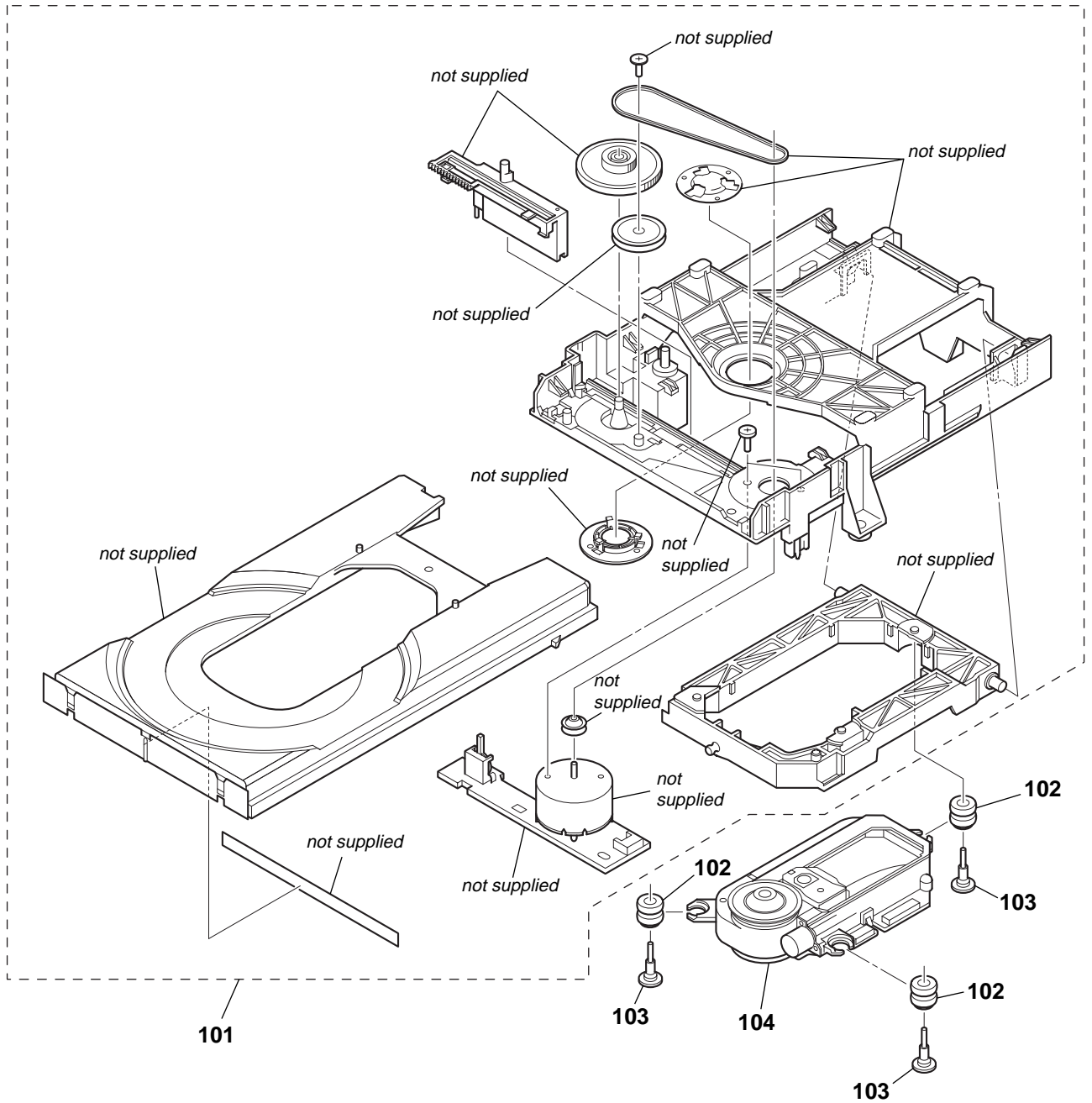

<p>The components identified by mark Δ or dotted line with mark Δ are critical for safety. Replace only with part number specified.</p>	<p>Les composants identifiés par une marque Δ sont critiques pour la sécurité. Ne les remplacer que par une pièce portant le numéro spécifié.</p>
---	---

Ref. No.	Part No.	Description	Remark	Ref. No.	Part No.	Description	Remark
101	A-6062-514-A	LOADING ASSY (M)		103	3-067-344-01	INSULATOR SCREW	
102	3-053-847-11	INSULATOR		Δ 104	A-4900-650-A	OPTICAL PICK-UP KHM-250 AAA/J1NP	

8-2. ELECTRICAL PARTS LIST

NOTE:

- Due to standardization, replacements in the parts list may be different from the parts specified in the diagrams or the components used on the set.
- -XX and -X mean standardized parts, so they may have some difference from the original one.
- RESISTORS
All resistors are in ohms.
METAL: Metal-film resistor.
METAL OXIDE: Metal oxide-film resistor.
F: nonflammable
- Not all of the parts for POWER BLOCK (HS13SOE, HS13S0F, HS13S0U and TOP-244U) are listed.

- Items marked “*” are not stocked since they are seldom required for routine service. Some delay should be anticipated when ordering these items.

- SEMICONDUCTORS
In each case, u: μ , for example:
uA. . : μ A. . uPA. . : μ PA. .
uPB. . : μ PB. . uPC. . : μ PC. .
uPD. . : μ PD. .

- CAPACITORS

- uF: μ F

- COILS

- uH: μ H

- Abbreviation

AR : Argentina	E32 : 110-240 V AC Area in E	MX : Mexican
AUS : Australian	EA : Saudi Arabia	RUS : Russian
BR : Brazilian	HK : Hong Kong	SP : Singapore
CND : Canadian	KR : Korea	TW : Taiwan
E12 : 220-240 V AC Area in E	ME : Middle East	

- Description about model name

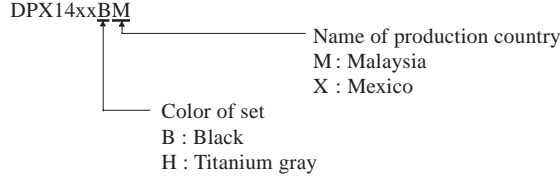

The components identified by mark Δ or dotted line with mark Δ are critical for safety.
Replace only with part number specified.

Les composants identifiés par une marque Δ sont critiques pour la sécurité.
Ne les remplacer que par une pièce portant le numéro spécifié.

When indicating parts by reference number, please include the board.

Ref. No.	Part No.	Description	Remark	Ref. No.	Part No.	Description	Remark
*	A-6065-645-A	AV-56 BOARD, COMPLETE (AEP, UK, RUS)		C216	1-164-230-11	CERAMIC CHIP 220PF	5% 50V
*	A-6065-649-A	AV-56 BOARD, COMPLETE (E12, EA, ME, HK, KR, SP, TW, AUS)		C222	1-162-970-11	CERAMIC CHIP 0.01uF	10% 25V
*	A-6065-662-A	AV-56 BOARD, COMPLETE (US, (DPX1400BX), MX (DPX1400HX))		C223	1-162-970-11	CERAMIC CHIP 0.01uF	10% 25V
*	A-6065-702-A	AV-56 BOARD, COMPLETE (US (DPX1400BM), US (DPX1400HM), CND, E32, MX (DPX1400HM), BR, PX, AR)		C224	1-104-664-11	ELECT 47uF	20% 16V
***** (Ref. No. 1,000 Series)				C226	1-164-230-11	CERAMIC CHIP 220PF	5% 50V
< CAPACITOR >				C227	1-104-664-11	ELECT 47uF	20% 16V
C101	1-162-970-11	CERAMIC CHIP	0.01uF 10% 25V	C228	1-104-664-11	ELECT 47uF	20% 16V
C102	1-104-664-11	ELECT	47uF 20% 16V	C229	1-104-664-11	ELECT 47uF	20% 16V
C109	1-165-176-11	CERAMIC CHIP	0.047uF 10% 16V	C231	1-126-934-11	ELECT 220uF	20% 16V
C110	1-104-664-11	ELECT	47uF 20% 16V	C242	1-126-924-11	ELECT 330uF	20% 6.3V
C111	1-104-664-11	ELECT	47uF 20% 16V	C244	1-104-664-11	ELECT 47uF	20% 16V
C112	1-107-826-11	CERAMIC CHIP	0.1uF 10% 16V	< CONNECTOR >			
C113	1-104-664-11	ELECT	47uF 20% 16V	CN102	1-815-149-11	CONNECTOR, FPC/FFC (1MM PIC) 21P	(AEP, UK, RUS)
C114	1-107-826-11	CERAMIC CHIP	0.1uF 10% 16V	* CN202	1-568-934-11	PIN, CONNECTOR 7P	
C201	1-164-739-11	CERAMIC CHIP	560PF 5% 50V	CN203	1-815-390-11	CONNECTOR, FFC/FPC 25P	
C202	1-164-739-11	CERAMIC CHIP	560PF 5% 50V	< DIODE >			
C203	1-164-218-11	CERAMIC CHIP	180PF 5% 50V	D004	8-719-071-15	DIODE HZM6.8ZWA1TL	
C204	1-164-218-11	CERAMIC CHIP	180PF 5% 50V	D005	8-719-071-15	DIODE HZM6.8ZWA1TL	
C205	1-164-218-11	CERAMIC CHIP	180PF 5% 50V	D201	8-719-914-43	DIODE DAN202K-T-146	
C206	1-164-218-11	CERAMIC CHIP	180PF 5% 50V	D202	8-719-914-44	DIODE DAP202K-T-146	
C207	1-162-970-11	CERAMIC CHIP	0.01uF 10% 25V	D203	8-719-914-44	DIODE DAP202K-T-146	(AEP, UK, RUS)
C208	1-162-970-11	CERAMIC CHIP	0.01uF 10% 25V	D205	8-719-988-61	DIODE 1SS355TE-17	
C209	1-126-960-11	ELECT	1uF 20% 50V	< EARTH TERMINAL >			
C210	1-104-664-11	ELECT	47uF 20% 16V	* ET201	1-537-738-21	TERMINAL, EARTH	
C211	1-104-664-11	ELECT	47uF 20% 16V	< IC >			
C212	1-126-960-11	ELECT	1uF 20% 50V (AEP, UK, RUS)	IC101	8-759-667-17	IC L79M05TLL-SONY-TL	
C215	1-164-230-11	CERAMIC CHIP	220PF 5% 50V (AEP, UK, RUS)	IC102	8-759-826-45	IC LA73050-TLM (EXCEPT AEP, UK, RUS)	
				IC102	8-759-826-46	IC LA73051-TLM (AEP, UK, RUS)	

Ref. No.	Part No.	Description	Remark	Ref. No.	Part No.	Description	Remark
IC201	8-759-909-71	IC BA4558F-E2		R129	1-216-073-00	METAL CHIP	10K 5% 1/10W
IC203	8-759-711-59	IC NJM78L05UA-TE1		R130	1-216-021-00	METAL CHIP	68 5% 1/10W
IC204	8-749-017-31	IC GP1FA550TZ (DIGITAL OUT - OPTICAL) (EXCEPT AEP, UK, RUS)		R131	1-216-021-00	METAL CHIP	68 5% 1/10W
	< JACK >			R133	1-216-021-00	METAL CHIP	68 5% 1/10W
J101	1-815-358-11	JACK, PIN (3P) (LINE OUT) (AEP, UK, RUS)		R134	1-216-021-00	METAL CHIP	68 5% 1/10W
J101	1-815-362-11	JACK, PIN (6P) (LINE OUT) (EXCEPT AEP, UK, RUS)		R201	1-208-798-11	METAL CHIP	4.7K 0.5% 1/10W
J102	1-815-360-11	JACK, PIN (3P) (COMPONENT VIDEO OUT) (EXCEPT AEP, UK, RUS)		R202	1-208-798-11	METAL CHIP	4.7K 0.5% 1/10W
J103	1-794-198-11	CONNECTOR, S TERMINAL (S VIDEO OUT)		R203	1-208-798-11	METAL CHIP	4.7K 0.5% 1/10W
J201	1-793-446-21	JACK, PIN 1P (DIGITAL OUT - COAXIAL)		R204	1-208-798-11	METAL CHIP	4.7K 0.5% 1/10W
	< JUMPER RESISTOR >			R205	1-208-800-11	METAL CHIP	5.6K 0.5% 1/10W
JR201	1-216-295-11	SHORT	0	R206	1-208-800-11	METAL CHIP	5.6K 0.5% 1/10W
JR202	1-216-295-11	SHORT	0	R207	1-216-057-00	METAL CHIP	2.2K 5% 1/10W
JR203	1-216-295-11	SHORT	0	R208	1-216-057-00	METAL CHIP	2.2K 5% 1/10W
JR204	1-216-295-11	SHORT	0	R209	1-216-057-00	METAL CHIP	2.2K 5% 1/10W
JR205	1-216-295-11	SHORT	0	R210	1-216-057-00	METAL CHIP	2.2K 5% 1/10W
JR206	1-216-295-11	SHORT	0	R211	1-208-800-11	METAL CHIP	5.6K 0.5% 1/10W
JR207	1-216-295-11	SHORT	0	R212	1-208-800-11	METAL CHIP	5.6K 0.5% 1/10W
JR208	1-216-295-11	SHORT	0	R213	1-216-065-00	RES-CHIP	4.7K 5% 1/10W
JR209	1-216-295-11	SHORT	0	R214	1-216-065-00	RES-CHIP	4.7K 5% 1/10W
JR210	1-216-295-11	SHORT	0				(AEP, UK, RUS)
JR211	1-216-295-11	SHORT	0	R216	1-216-067-00	METAL CHIP	5.6K 5% 1/10W
JR212	1-216-295-11	SHORT	0	R217	1-216-073-00	METAL CHIP	10K 5% 1/10W
JR213	1-216-295-11	SHORT	0	R218	1-216-097-11	RES-CHIP	100K 5% 1/10W
	< COIL >			R219	1-216-105-00	RES-CHIP	220K 5% 1/10W
L101	1-412-064-11	INDUCTOR	100uH	R220	1-216-041-00	METAL CHIP	470 5% 1/10W
	< TRANSISTOR >			R221	1-216-073-00	METAL CHIP	10K 5% 1/10W
Q104	8-729-421-19	TRANSISTOR	UN2213-TX	R222	1-216-073-00	METAL CHIP	10K 5% 1/10W
Q105	8-729-424-08	TRANSISTOR	UN2111-TX	R224	1-216-073-00	METAL CHIP	10K 5% 1/10W
Q106	8-729-216-22	TRANSISTOR	2SA1162-YG-TE85L (AEP, UK, RUS)	R225	1-216-089-11	RES-CHIP	47K 5% 1/10W
Q201	8-729-049-31	TRANSISTOR	2SB710-RTX	R226	1-216-041-00	METAL CHIP	470 5% 1/10W
Q202	8-729-421-19	TRANSISTOR	UN2213-TX	R227	1-216-041-00	METAL CHIP	470 5% 1/10W
Q203	8-729-230-49	TRANSISTOR	2SC2712-YG-TE85L	R228	1-216-073-00	METAL CHIP	10K 5% 1/10W
Q204	8-729-027-53	TRANSISTOR	DTC124TKA-T146	R229	1-216-089-11	RES-CHIP	47K 5% 1/10W
Q205	8-729-216-22	TRANSISTOR	2SB709A-QRS-TX	R230	1-216-089-11	RES-CHIP	47K 5% 1/10W
Q206	8-729-421-19	TRANSISTOR	UN2213-TX (AEP, UK, RUS)	R231	1-216-073-00	METAL CHIP	10K 5% 1/10W
Q207	8-729-046-97	TRANSISTOR	2SD1938 (F) -T (TX).SO				(AEP, UK, RUS)
Q208	8-729-046-97	TRANSISTOR	2SD1938 (F) -T (TX).SO	R232	1-216-073-00	METAL CHIP	10K 5% 1/10W
Q209	8-729-027-53	TRANSISTOR	DTC124TKA-T146 (AEP, UK, RUS)				(AEP, UK, RUS)
Q210	8-729-216-22	TRANSISTOR	2SB709A-QRS-TX (AEP, UK, RUS)	R233	1-216-089-11	RES-CHIP	47K 5% 1/10W
Q211	8-729-230-49	TRANSISTOR	2SC2712-YG-TE85L				(AEP, UK, RUS)
Q216	8-729-216-22	TRANSISTOR	2SB709A-QRS-TX	R234	1-216-065-00	RES-CHIP	4.7K 5% 1/10W
	< RESISTOR >			R235	1-216-065-00	RES-CHIP	4.7K 5% 1/10W
R121	1-216-073-00	METAL CHIP	10K 5% 1/10W				(EXCEPT AEP, UK, RUS)
R122	1-216-049-11	RES-CHIP	1K 5% 1/10W (AEP, UK, RUS)	R236	1-216-073-00	METAL CHIP	10K 5% 1/10W
R126	1-216-021-00	METAL CHIP	68 5% 1/10W (EXCEPT AEP, UK, RUS)				(AEP, UK, RUS)
R127	1-216-021-00	METAL CHIP	68 5% 1/10W (EXCEPT AEP, UK, RUS)	R237	1-216-065-00	RES-CHIP	4.7K 5% 1/10W
R128	1-216-021-00	METAL CHIP	68 5% 1/10W (EXCEPT AEP, UK, RUS)				(AEP, UK, RUS)
				R238	1-216-097-11	RES-CHIP	100K 5% 1/10W
				R239	1-216-097-11	RES-CHIP	100K 5% 1/10W
							(AEP, UK, RUS)
				R240	1-216-041-00	METAL CHIP	470 5% 1/10W
							(EXCEPT AEP, UK, RUS)
				R241	1-216-041-00	METAL CHIP	470 5% 1/10W
				R242	1-216-041-00	METAL CHIP	470 5% 1/10W
							(EXCEPT AEP, UK, RUS)
				R243	1-216-041-00	METAL CHIP	470 5% 1/10W
				R249	1-216-033-00	METAL CHIP	220 5% 1/10W
				R251	1-216-021-00	METAL CHIP	68 5% 1/10W
				R252	1-216-073-00	METAL CHIP	10K 5% 1/10W
				R253	1-216-049-11	RES-CHIP	1K 5% 1/10W

AV-56	ER-14	IF-80
--------------	--------------	--------------

Ref. No.	Part No.	Description	Remark
R254	1-216-049-11	RES-CHIP 1K 5%	1/10W
R256	1-216-049-11	RES-CHIP 1K 5%	1/10W
R279	1-216-295-11	SHORT	0
<hr/>			
*	A-6065-648-A	ER-14 BOARD, COMPLETE (AEP, UK, RUS) ***** (Ref. No. 1,000 Series)	
< CAPACITOR >			
C901	1-104-664-11	ELECT 47uF 20%	16V
C902	1-104-664-11	ELECT 47uF 20%	16V
C903	1-104-664-11	ELECT 47uF 20%	16V
C905	1-104-664-11	ELECT 47uF 20%	16V
C907	1-104-664-11	ELECT 47uF 20%	16V
C913	1-127-715-11	CERAMIC CHIP 0.22uF 10%	16V
C914	1-127-715-11	CERAMIC CHIP 0.22uF 10%	16V
C943	1-162-927-11	CERAMIC CHIP 100PF 5%	50V
C945	1-162-927-11	CERAMIC CHIP 100PF 5%	50V
C962	1-162-927-11	CERAMIC CHIP 100PF 5%	50V
C963	1-162-927-11	CERAMIC CHIP 100PF 5%	50V
< CONNECTOR >			
CN901	1-815-387-11	CONNECTOR, FPC/FFC 21P	
< JACK >			
CNJ902	1-251-780-11	SOCKET, PIN (21P) (LINE 1 (RGB) - TV)	
< DIODE >			
D901	8-719-988-61	DIODE 1SS355TE-17	
D907	8-719-914-44	DIODE DAP202K-T-146	
D917	8-719-071-15	DIODE HZM6.8ZWA1TL	
D918	8-719-071-15	DIODE HZM6.8ZWA1TL	
D919	8-719-071-15	DIODE HZM6.8ZWA1TL	
D920	8-719-071-15	DIODE HZM6.8ZWA1TL	
D929	8-719-056-82	DIODE UDZ-TE-17-6.2B	
D930	8-719-977-40	DIODE UDZ-TE-17-13B	
< FERRITE BEAD >			
FB907	1-414-766-22	FERRITE 0uH	
FB907	1-469-130-11	FERRITE 0uH	
FB907	1-469-796-21	FERRITE 0uH	
FB908	1-414-766-22	FERRITE 0uH	
FB908	1-469-130-11	FERRITE 0uH	
FB908	1-469-796-21	FERRITE 0uH	
FB909	1-414-766-22	FERRITE 0uH	
FB909	1-469-130-11	FERRITE 0uH	
FB909	1-469-796-21	FERRITE 0uH	
FB910	1-414-766-22	FERRITE 0uH	
FB910	1-469-130-11	FERRITE 0uH	
FB910	1-469-796-21	FERRITE 0uH	
< IC >			
IC901	8-759-826-47	IC LA73052-TLM	
< JUMPER RESISTOR >			
JR901	1-216-295-11	SHORT	0
JR902	1-216-295-11	SHORT	0
JR905	1-216-295-11	SHORT	0
JR906	1-216-295-11	SHORT	0

Ref. No.	Part No.	Description	Remark
JR907	1-216-295-11	SHORT	0
JR908	1-216-295-11	SHORT	0
JR909	1-216-295-11	SHORT	0
JR910	1-216-295-11	SHORT	0
JR911	1-216-295-11	SHORT	0
JR912	1-216-295-11	SHORT	0
JR913	1-216-295-11	SHORT	0
JR914	1-216-295-11	SHORT	0
JR915	1-216-295-11	SHORT	0
< COIL >			
L905	1-412-064-11	INDUCTOR	100uH
< TRANSISTOR >			
Q901	8-729-421-19	TRANSISTOR	UN2213-TX
Q902	8-729-422-27	TRANSISTOR	2SD601A-QRS-TX
Q903	8-729-424-08	TRANSISTOR	UN2111-TX
Q906	8-729-421-19	TRANSISTOR	UN2213-TX
Q907	8-729-424-08	TRANSISTOR	UN2111-TX
Q908	8-729-421-22	TRANSISTOR	UN2211-TX
< RESISTOR >			
R902	1-216-295-11	SHORT	0
R905	1-216-089-11	RES-CHIP 47K 5%	1/10W
R906	1-216-089-11	RES-CHIP 47K 5%	1/10W
R907	1-216-089-11	RES-CHIP 47K 5%	1/10W
R908	1-216-105-00	RES-CHIP 220K 5%	1/10W
R909	1-216-037-00	METAL CHIP 330 5%	1/10W
R910	1-216-037-00	METAL CHIP 330 5%	1/10W
R911	1-216-037-00	METAL CHIP 330 5%	1/10W
R912	1-216-037-00	METAL CHIP 330 5%	1/10W
R914	1-216-057-00	METAL CHIP 2.2K 5%	1/10W
R915	1-216-049-11	RES-CHIP 1K 5%	1/10W
R916	1-216-057-00	METAL CHIP 2.2K 5%	1/10W
R917	1-216-057-00	METAL CHIP 2.2K 5%	1/10W
R918	1-216-021-00	METAL CHIP 68 5%	1/10W
R924	1-216-041-00	METAL CHIP 470 5%	1/10W
R926	1-216-041-00	METAL CHIP 470 5%	1/10W
R927	1-216-021-00	METAL CHIP 68 5%	1/10W
R928	1-216-021-00	METAL CHIP 68 5%	1/10W
R929	1-216-021-00	METAL CHIP 68 5%	1/10W
R939	1-216-017-00	RES-CHIP 47 5%	1/10W
R950	1-216-081-00	METAL CHIP 22K 5%	1/10W
R957	1-414-233-22	FERRITE 0uH	
R958	1-414-233-22	FERRITE 0uH	
<hr/>			
*	A-6065-647-A	IF-80 BOARD, COMPLETE (AEP, UK, RUS)	
*	A-6065-651-A	IF-80 BOARD, COMPLETE (EXCEPT AEP, UK, RUS, US, (DPX1400BX), MX (DPX1400HX), BR)	
*	A-6065-663-A	IF-80 BOARD, COMPLETE (US, (DPX1400BX), MX (DPX1400HX))	
*	A-6065-706-A	IF-80 BOARD, COMPLETE (BR) ***** (Ref. No. 1,000 Series)	
3-067-209-01	HOLDER, FL		(US, (DPX1400BX),MX (DPX1400HX))
3-067-239-01	HOLDER, FL (EXCEPT US, (DPX1400BX), MX (DPX1400HX), BR)		

Ref. No.	Part No.	Description	Remark	Ref. No.	Part No.	Description	Remark
	3-067-239-11	HOLDER, FL (BR)				< JUMPER RESISTOR >	
		< BUZZER >		JR401	1-216-295-11	SHORT 0	
BZ401	1-529-986-11	BUZZER, VOLTAGE		JR402	1-216-295-11	SHORT 0	
		< CAPACITOR >				< COIL >	
C401	1-162-970-11	CERAMIC CHIP 0.01uF 10%	25V	L401	1-408-978-21	INDUCTOR 47uH	
C402	1-104-664-11	ELECT 47uF 20%	16V			< FLUORESCENT INDICATOR TUBE >	
C404	1-162-970-11	CERAMIC CHIP 0.01uF 10%	25V	ND401	1-517-971-11	INDICATOR TUBE, FLUORESCENT	
C407	1-162-970-11	CERAMIC CHIP 0.01uF 10%	25V			< IC LINK >	
C409	1-162-970-11	CERAMIC CHIP 0.01uF 10%	25V	△ PS401	1-576-509-21	LINK, IC (1.0 A)	
C411	1-126-933-11	ELECT 100uF 20%	16V	△ PS402	1-576-509-21	LINK, IC (1.0 A)	
C412	1-162-970-11	CERAMIC CHIP 0.01uF 10%	25V			< TRANSISTOR >	
C414	1-162-970-11	CERAMIC CHIP 0.01uF 10%	25V	Q401	8-729-056-46	TRANSISTOR 2SC5053T100Q	
C416	1-162-970-11	CERAMIC CHIP 0.01uF 10%	25V	Q402	8-729-056-46	TRANSISTOR 2SC5053T100Q	
C417	1-162-968-11	CERAMIC CHIP 0.0047uF 10%	50V	Q404	8-729-048-28	TRANSISTOR 2SD1766-T100-QR	
C419	1-104-666-11	ELECT 220uF 20%	25V	Q405	8-729-424-08	TRANSISTOR UN2111-TX	
C420	1-162-970-11	CERAMIC CHIP 0.01uF 10%	25V			< RESISTOR >	
C421	1-162-964-11	CERAMIC CHIP 0.001uF 10%	50V	R401	1-216-065-00	RES-CHIP 4.7K 5%	1/10W
C422	1-115-339-11	CERAMIC CHIP 0.1uF 10%	50V	R402	1-216-097-11	RES-CHIP 100K 5%	1/10W
C423	1-107-826-11	CERAMIC CHIP 0.1uF 10%	16V	R412	1-216-017-00	RES-CHIP 47 5%	1/10W
C425	1-128-131-11	ELECT 22uF 20%	50V	R413	1-216-067-00	METAL CHIP 5.6K 5%	1/10W
C426	1-124-234-00	ELECT 22uF 20%	16V	R414	1-216-059-00	METAL CHIP 2.7K 5%	1/10W
C427	1-162-970-11	CERAMIC CHIP 0.01uF 10%	25V	R415	1-216-055-00	METAL CHIP 1.8K 5%	1/10W
C428	1-162-970-11	CERAMIC CHIP 0.01uF 10%	25V	R416	1-216-055-00	METAL CHIP 1.8K 5%	1/10W
C429	1-126-933-11	ELECT 100uF 20%	16V	R417	1-216-097-11	RES-CHIP 100K 5%	1/10W
C430	1-163-131-00	CERAMIC CHIP 390PF 5%	50V	R418	1-216-073-00	METAL CHIP 10K 5%	1/10W
C431	1-115-339-11	CERAMIC CHIP 0.1uF 10%	50V	R420	1-216-025-11	RES-CHIP 100 5%	1/10W
C432	1-162-970-11	CERAMIC CHIP 0.01uF 10%	25V	R421	1-216-059-00	METAL CHIP 2.7K 5%	1/10W
C436	1-163-131-00	CERAMIC CHIP 390PF 5%	50V	R422	1-216-071-00	METAL CHIP 8.2K 5%	1/10W
C437	1-162-970-11	CERAMIC CHIP 0.01uF 10%	25V	R423	1-216-081-00	METAL CHIP 22K 5%	1/10W
		< CONNECTOR >		R424	1-216-013-00	METAL CHIP 33 5%	1/10W
CN401	1-778-317-11	CONNECTOR, BOARD TO BOARD 13P		R425	1-216-025-11	RES-CHIP 100 5%	1/10W
CN402	1-815-381-11	CONNECTOR, FPC/FFC 5P		R427	1-216-063-00	RES-CHIP 3.9K 5%	1/10W
CN403	1-815-458-21	CONNECTOR, BOARD TO BOARD 15P		R428	1-216-071-00	METAL CHIP 8.2K 5%	1/10W
* CN405	1-785-530-11	PIN, CONNECTOR (PC BOARD) 10P		R429	1-216-067-00	METAL CHIP 5.6K 5%	1/10W
		< DIODE >		R430	1-216-059-00	METAL CHIP 2.7K 5%	1/10W
D403	8-719-041-97	DIODE MA113-(TX)		R431	1-216-063-00	RES-CHIP 3.9K 5%	1/10W
D404	8-719-041-97	DIODE MA113-(TX)		R433	1-216-073-00	METAL CHIP 10K 5%	1/10W
D405	8-719-041-97	DIODE MA113-(TX)		R434	1-216-073-00	METAL CHIP 10K 5%	1/10W
D406	8-719-041-97	DIODE MA113-(TX)		R435	1-216-073-00	METAL CHIP 10K 5%	1/10W
D412	8-719-422-62	DIODE MA8062-L-TX		R437	1-216-027-00	METAL CHIP 120 5%	1/10W
D414	8-719-056-06	DIODE SLR-342DCT32 (BNR)		R440	1-216-073-00	METAL CHIP 10K 5%	1/10W
D415	8-719-056-06	DIODE SLR-342DCT32 (SURROUND)		R444	1-216-025-11	RES-CHIP 100 5%	1/10W
		< FERRITE BEAD >		R446	1-216-097-11	RES-CHIP 100K 5%	1/10W
FB401	1-469-324-21	FERRITE 0uH		R448	1-216-073-00	METAL CHIP 10K 5%	1/10W
		< IC >		R449	1-216-073-00	METAL CHIP 10K 5%	1/10W
IC401	8-749-019-11	IC GP1UD28SYK		R450	1-216-073-00	METAL CHIP 10K 5%	1/10W
IC403	8-759-832-05	IC BA18BC0FP-E2		R455	1-216-073-00	METAL CHIP 10K 5%	1/10W
IC404	6-800-321-01	IC TMP86CK74F-3CB8		R460	1-216-295-11	SHORT 0	
IC405	8-759-684-35	IC S-80830ANUP-EDT-T2		R470	1-216-073-00	METAL CHIP 10K 5%	1/10W
				R473	1-216-073-00	METAL CHIP 10K 5%	1/10W
				R474	1-216-025-11	RES-CHIP 100 5%	1/10W

The components identified by mark △ or dotted line with mark △ are critical for safety. Replace only with part number specified.	Les composants identifiés par une marque △ sont critiques pour la sécurité. Ne les remplacer que par une pièce portant le numéro spécifié.
--	--

Ref. No.	Part No.	Description	Remark
R481	1-216-025-11	RES-CHIP 100 5%	1/10W
R482	1-216-025-11	RES-CHIP 100 5%	1/10W
R483	1-216-025-11	RES-CHIP 100 5%	1/10W
R484	1-216-025-11	RES-CHIP 100 5%	1/10W
R485	1-216-025-11	RES-CHIP 100 5%	1/10W
R486	1-216-033-00	METAL CHIP 220 5%	1/10W
R487	1-216-033-00	METAL CHIP 220 5%	1/10W
R490	1-216-081-00	METAL CHIP 22K 5%	1/10W
< SWITCH >			
S401	1-771-574-21	SWITCH, TACTILE (BNR)	
S402	1-771-574-21	SWITCH, TACTILE (TITLE)	
S403	1-771-574-21	SWITCH, TACTILE (▶▶)	
S404	1-771-574-21	SWITCH, TACTILE (SURROUND)	
S405	1-771-574-21	SWITCH, TACTILE (↶ RETURN)	
S406	1-771-574-21	SWITCH, TACTILE (■)	
S407	1-771-574-21	SWITCH, TACTILE (DVD MENU)	
S408	1-771-574-21	SWITCH, TACTILE (◀◀)	
S409	1-771-574-21	SWITCH, TACTILE (DISPLAY)	
S410	1-771-574-21	SWITCH, TACTILE (■)	
S411	1-771-574-21	SWITCH, TACTILE (▷)	
S412	1-771-574-21	SWITCH, TACTILE (△)	
< TRANSFORMER >			
T401	1-435-912-11	TRANSFORMER, CONVERTER	
< VIBRATOR >			
X401	1-781-472-21	VIBRATOR, CERAMIC (8 MHz)	
<hr style="border: 2px solid black;"/>			
*	A-6065-646-A	MB-98 BOARD, COMPLETE (AEP (DPX1401BM), AEP (DPX1401HM), UK)	
*	A-6065-650-A	MB-98 BOARD, COMPLETE (US (DPX1400BM) US (DPX1400HM), CND, PX)	
*	A-6065-654-A	MB-98 BOARD, COMPLETE (AEP (DPX1402BM), AEP (DPX1402HM))	
*	A-6065-655-A	MB-98 BOARD, COMPLETE (MX (DPX1400HM), E32, AR, BR)	
*	A-6065-656-A	MB-98 BOARD, COMPLETE (RUS)	
*	A-6065-657-A	MB-98 BOARD, COMPLETE (E12)	
*	A-6065-658-A	MB-98 BOARD, COMPLETE (EA, ME)	
*	A-6065-659-A	MB-98 BOARD, COMPLETE (AUS)	
*	A-6065-660-A	MB-98 BOARD, COMPLETE (HK, KR, SP, TW)	
*	A-6065-661-A	MB-98 BOARD, COMPLETE (US (DPX1400BX))	
*	A-6065-672-A	MB-98 BOARD, COMPLETE (MX (DPX1400HX)) ***** (Ref. No. 2,000 Series)	
< CAPACITOR >			
C103	1-162-970-11	CERAMIC CHIP 0.01uF 10%	25V
C104	1-126-209-11	ELECT CHIP 100uF 20%	4V
C105	1-162-970-11	CERAMIC CHIP 0.01uF 10%	25V
C106	1-162-970-11	CERAMIC CHIP 0.01uF 10%	25V
C107	1-162-914-11	CERAMIC CHIP 9PF 0.5PF	50V (EXCEPT AEP, UK, RUS)
C107	1-162-917-11	CERAMIC CHIP 15PF 5%	50V (AEP, UK, RUS)
C108	1-162-914-11	CERAMIC CHIP 9PF 0.5PF	50V (EXCEPT AEP, UK, RUS)
C108	1-162-917-11	CERAMIC CHIP 15PF 5%	50V (AEP, UK, RUS)

Ref. No.	Part No.	Description	Remark
C109	1-162-970-11	CERAMIC CHIP 0.01uF 10%	25V
C110	1-126-209-11	ELECT CHIP 100uF 20%	4V
C111	1-162-970-11	CERAMIC CHIP 0.01uF 10%	25V
C112	1-107-826-11	CERAMIC CHIP 0.1uF 10%	16V
C113	1-162-970-11	CERAMIC CHIP 0.01uF 10%	25V
C114	1-162-970-11	CERAMIC CHIP 0.01uF 10%	25V
C115	1-162-970-11	CERAMIC CHIP 0.01uF 10%	25V
C116	1-162-970-11	CERAMIC CHIP 0.01uF 10%	25V
C118	1-126-607-11	ELECT CHIP 47uF 20%	4V
C121	1-126-206-11	ELECT CHIP 100uF 20%	6.3V
C122	1-126-204-11	ELECT CHIP 47uF 20%	16V
C123	1-126-246-11	ELECT CHIP 220uF 20%	4V
C124	1-162-970-11	CERAMIC CHIP 0.01uF 10%	25V
C201	1-162-970-11	CERAMIC CHIP 0.01uF 10%	25V
C202	1-162-970-11	CERAMIC CHIP 0.01uF 10%	25V
C205	1-162-966-11	CERAMIC CHIP 0.0022uF 10%	50V
C206	1-162-966-11	CERAMIC CHIP 0.0022uF 10%	50V
C207	1-162-966-11	CERAMIC CHIP 0.0022uF 10%	50V
C208	1-162-966-11	CERAMIC CHIP 0.0022uF 10%	50V
C209	1-124-779-00	ELECT CHIP 10uF 20%	16V
C215	1-162-968-11	CERAMIC CHIP 0.0047uF 10%	50V
C216	1-162-968-11	CERAMIC CHIP 0.0047uF 10%	50V
C217	1-126-205-11	ELECT CHIP 47uF 20%	6.3V
C218	1-162-970-11	CERAMIC CHIP 0.01uF 10%	25V
C219	1-164-739-11	CERAMIC CHIP 560PF 5%	50V
C222	1-107-826-11	CERAMIC CHIP 0.1uF 10%	16V
C225	1-107-826-11	CERAMIC CHIP 0.1uF 10%	16V
C226	1-162-970-11	CERAMIC CHIP 0.01uF 10%	25V
C227	1-162-970-11	CERAMIC CHIP 0.01uF 10%	25V
C228	1-162-970-11	CERAMIC CHIP 0.01uF 10%	25V
C231	1-107-826-11	CERAMIC CHIP 0.1uF 10%	16V
C232	1-107-826-11	CERAMIC CHIP 0.1uF 10%	16V
C233	1-162-964-11	CERAMIC CHIP 0.001uF 10%	50V
C234	1-162-970-11	CERAMIC CHIP 0.01uF 10%	25V
C235	1-107-826-11	CERAMIC CHIP 0.1uF 10%	16V
C236	1-165-176-11	CERAMIC CHIP 0.047uF 10%	16V
C238	1-165-176-11	CERAMIC CHIP 0.047uF 10%	16V
C239	1-162-970-11	CERAMIC CHIP 0.01uF 10%	25V
C240	1-164-217-11	CERAMIC CHIP 150PF 5%	50V
C243	1-107-826-11	CERAMIC CHIP 0.1uF 10%	16V
C244	1-124-779-00	ELECT CHIP 10uF 20%	16V
C246	1-162-970-11	CERAMIC CHIP 0.01uF 10%	25V
C247	1-107-826-11	CERAMIC CHIP 0.1uF 10%	16V
C248	1-162-970-11	CERAMIC CHIP 0.01uF 10%	25V
C304	1-126-206-11	ELECT CHIP 100uF 20%	6.3V
C305	1-162-970-11	CERAMIC CHIP 0.01uF 10%	25V
C306	1-162-968-11	CERAMIC CHIP 0.0047uF 10%	50V
C307	1-162-970-11	CERAMIC CHIP 0.01uF 10%	25V
C309	1-162-968-11	CERAMIC CHIP 0.0047uF 10%	50V
C310	1-162-968-11	CERAMIC CHIP 0.0047uF 10%	50V
C311	1-162-968-11	CERAMIC CHIP 0.0047uF 10%	50V
C312	1-107-826-11	CERAMIC CHIP 0.1uF 10%	16V
C313	1-164-677-11	CERAMIC CHIP 0.033uF 10%	16V
C315	1-162-927-11	CERAMIC CHIP 100PF 5%	50V
C317	1-162-970-11	CERAMIC CHIP 0.01uF 10%	25V
C318	1-162-970-11	CERAMIC CHIP 0.01uF 10%	25V
C319	1-110-563-11	CERAMIC CHIP 0.068uF 10%	16V
C320	1-162-970-11	CERAMIC CHIP 0.01uF 10%	25V
C321	1-162-970-11	CERAMIC CHIP 0.01uF 10%	25V
C322	1-162-970-11	CERAMIC CHIP 0.01uF 10%	25V

Ref. No.	Part No.	Description	Remark	Ref. No.	Part No.	Description	Remark
C323	1-162-970-11	CERAMIC CHIP	0.01uF 10% 25V	C514	1-162-970-11	CERAMIC CHIP	0.01uF 10% 25V
C324	1-162-970-11	CERAMIC CHIP	0.01uF 10% 25V	C516	1-162-970-11	CERAMIC CHIP	0.01uF 10% 25V
C325	1-162-970-11	CERAMIC CHIP	0.01uF 10% 25V	C518	1-107-826-11	CERAMIC CHIP	0.1uF 10% 16V
C326	1-162-970-11	CERAMIC CHIP	0.01uF 10% 25V	C519	1-162-970-11	CERAMIC CHIP	0.01uF 10% 25V
C327	1-107-826-11	CERAMIC CHIP	0.1uF 10% 16V	C520	1-162-970-11	CERAMIC CHIP	0.01uF 10% 25V
C328	1-162-970-11	CERAMIC CHIP	0.01uF 10% 25V	C521	1-107-826-11	CERAMIC CHIP	0.1uF 10% 16V
C331	1-162-970-11	CERAMIC CHIP	0.01uF 10% 25V	C522	1-162-970-11	CERAMIC CHIP	0.01uF 10% 25V
C332	1-162-970-11	CERAMIC CHIP	0.01uF 10% 25V	C523	1-162-970-11	CERAMIC CHIP	0.01uF 10% 25V
C333	1-162-970-11	CERAMIC CHIP	0.01uF 10% 25V	C524	1-162-970-11	CERAMIC CHIP	0.01uF 10% 25V
C334	1-162-970-11	CERAMIC CHIP	0.01uF 10% 25V	C525	1-162-970-11	CERAMIC CHIP	0.01uF 10% 25V
C335	1-162-970-11	CERAMIC CHIP	0.01uF 10% 25V	C526	1-162-970-11	CERAMIC CHIP	0.01uF 10% 25V
C336	1-162-970-11	CERAMIC CHIP	0.01uF 10% 25V	C528	1-162-970-11	CERAMIC CHIP	0.01uF 10% 25V
C337	1-162-970-11	CERAMIC CHIP	0.01uF 10% 25V	C529	1-162-970-11	CERAMIC CHIP	0.01uF 10% 25V
C338	1-162-970-11	CERAMIC CHIP	0.01uF 10% 25V	C530	1-162-970-11	CERAMIC CHIP	0.01uF 10% 25V
C339	1-162-970-11	CERAMIC CHIP	0.01uF 10% 25V	C531	1-162-970-11	CERAMIC CHIP	0.01uF 10% 25V
C340	1-162-970-11	CERAMIC CHIP	0.01uF 10% 25V	C532	1-162-970-11	CERAMIC CHIP	0.01uF 10% 25V
C341	1-162-970-11	CERAMIC CHIP	0.01uF 10% 25V	C533	1-162-970-11	CERAMIC CHIP	0.01uF 10% 25V (EXCEPT US, CND, MX, AR, BR, E32, PX)
C342	1-162-970-11	CERAMIC CHIP	0.01uF 10% 25V	C534	1-162-970-11	CERAMIC CHIP	0.01uF 10% 25V (EXCEPT US, CND, MX, AR, BR, E32, PX)
C343	1-162-970-11	CERAMIC CHIP	0.01uF 10% 25V	C535	1-162-970-11	CERAMIC CHIP	0.01uF 10% 25V (EXCEPT US, CND, MX, AR, BR, E32, PX)
C344	1-162-970-11	CERAMIC CHIP	0.01uF 10% 25V	C536	1-162-970-11	CERAMIC CHIP	0.01uF 10% 25V (EXCEPT US, CND, MX, AR, BR, E32, PX)
C346	1-162-968-11	CERAMIC CHIP	0.0047uF 10% 50V	C537	1-162-970-11	CERAMIC CHIP	0.01uF 10% 25V (EXCEPT US, CND, MX, AR, BR, E32, PX)
C347	1-162-970-11	CERAMIC CHIP	0.01uF 10% 25V	C538	1-162-970-11	CERAMIC CHIP	0.01uF 10% 25V
C348	1-162-970-11	CERAMIC CHIP	0.01uF 10% 25V	C539	1-162-970-11	CERAMIC CHIP	0.01uF 10% 25V
C349	1-162-970-11	CERAMIC CHIP	0.01uF 10% 25V	C540	1-162-970-11	CERAMIC CHIP	0.01uF 10% 25V
C350	1-162-970-11	CERAMIC CHIP	0.01uF 10% 25V	C541	1-162-970-11	CERAMIC CHIP	0.01uF 10% 25V
C351	1-162-970-11	CERAMIC CHIP	0.01uF 10% 25V	C542	1-162-970-11	CERAMIC CHIP	0.01uF 10% 25V
C401	1-164-245-11	CERAMIC CHIP	0.015uF 10% 25V	C544	1-162-970-11	CERAMIC CHIP	0.01uF 10% 25V
C402	1-164-230-11	CERAMIC CHIP	220PF 5% 50V	C545	1-162-970-11	CERAMIC CHIP	0.01uF 10% 25V
C403	1-162-927-11	CERAMIC CHIP	100PF 5% 50V	C546	1-162-970-11	CERAMIC CHIP	0.01uF 10% 25V
C404	1-162-965-11	CERAMIC CHIP	0.0015uF 10% 50V	C547	1-162-970-11	CERAMIC CHIP	0.01uF 10% 25V
C405	1-107-826-11	CERAMIC CHIP	0.1uF 10% 16V	C601	1-162-970-11	CERAMIC CHIP	0.01uF 10% 25V
C406	1-107-826-11	CERAMIC CHIP	0.1uF 10% 16V	C602	1-162-970-11	CERAMIC CHIP	0.01uF 10% 25V
C407	1-164-230-11	CERAMIC CHIP	220PF 5% 50V	C603	1-162-970-11	CERAMIC CHIP	0.01uF 10% 25V
C408	1-162-927-11	CERAMIC CHIP	100PF 5% 50V	C604	1-162-970-11	CERAMIC CHIP	0.01uF 10% 25V
C409	1-162-964-11	CERAMIC CHIP	0.001uF 10% 50V	C802	1-162-970-11	CERAMIC CHIP	0.01uF 10% 25V
C410	1-162-964-11	CERAMIC CHIP	0.001uF 10% 50V	C807	1-162-970-11	CERAMIC CHIP	0.01uF 10% 25V
C411	1-162-968-11	CERAMIC CHIP	0.0047uF 10% 50V	C810	1-162-970-11	CERAMIC CHIP	0.01uF 10% 25V
C412	1-164-677-11	CERAMIC CHIP	0.033uF 10% 16V	C811	1-162-970-11	CERAMIC CHIP	0.01uF 10% 25V
C413	1-164-677-11	CERAMIC CHIP	0.033uF 10% 16V	C812	1-162-970-11	CERAMIC CHIP	0.01uF 10% 25V
C414	1-162-970-11	CERAMIC CHIP	0.01uF 10% 25V	C813	1-127-715-11	CERAMIC CHIP	0.22uF 10% 16V
C415	1-162-970-11	CERAMIC CHIP	0.01uF 10% 25V	C816	1-124-779-00	ELECT CHIP	10uF 20% 16V
C416	1-162-970-11	CERAMIC CHIP	0.01uF 10% 25V			< CONNECTOR >	
C417	1-162-964-11	CERAMIC CHIP	0.001uF 10% 50V	CN101	1-815-459-21	CONNECTOR, BOARD TO BOARD 15P	
C418	1-162-970-11	CERAMIC CHIP	0.01uF 10% 25V	* CN103	1-770-470-21	PIN, CONNECTOR (PC BOARD) 6P	
C419	1-126-204-11	ELECT CHIP	47uF 20% 16V	CN201	1-815-507-11	CONNECTOR, FFC/FPC 26P	
C420	1-107-826-11	CERAMIC CHIP	0.1uF 10% 16V	CN202	1-779-935-11	CONNECTOR, FFC/FPC 9P	
C421	1-107-826-11	CERAMIC CHIP	0.1uF 10% 16V	CN402	1-779-353-21	CONNECTOR, FFC/FPC 5P	
C427	1-162-964-11	CERAMIC CHIP	0.001uF 10% 50V	CN801	1-815-396-21	CONNECTOR, FFC/FPC 25P	
C428	1-162-964-11	CERAMIC CHIP	0.001uF 10% 50V			< FERRITE BEAD >	
C501	1-126-193-11	ELECT	1uF 20% 50V	FB102	1-469-324-21	FERRITE	0uH
C502	1-124-779-00	ELECT CHIP	10uF 20% 16V	FB103	1-469-324-21	FERRITE	0uH
C503	1-162-970-11	CERAMIC CHIP	0.01uF 10% 25V	FB104	1-469-324-21	FERRITE	0uH
C504	1-162-970-11	CERAMIC CHIP	0.01uF 10% 25V	FB105	1-469-324-21	FERRITE	0uH
C505	1-124-779-00	ELECT CHIP	10uF 20% 16V	FB106	1-469-324-21	FERRITE	0uH
C506	1-124-779-00	ELECT CHIP	10uF 20% 16V				
C508	1-162-970-11	CERAMIC CHIP	0.01uF 10% 25V				
C509	1-162-970-11	CERAMIC CHIP	0.01uF 10% 25V				
C510	1-162-970-11	CERAMIC CHIP	0.01uF 10% 25V				
C512	1-126-246-11	ELECT CHIP	220uF 20% 4V				
C513	1-162-970-11	CERAMIC CHIP	0.01uF 10% 25V				

MB-98

Ref. No.	Part No.	Description	Remark	Ref. No.	Part No.	Description	Remark
FB107	1-469-324-21	FERRITE	OuH	R116	1-216-833-11	METAL CHIP	10K 5% 1/16W
FB108	1-469-324-21	FERRITE	OuH	R117	1-216-821-11	METAL CHIP	1K 5% 1/16W
FB109	1-469-784-11	FERRITE	OuH	R118	1-216-821-11	METAL CHIP	1K 5% 1/16W
FB110	1-469-324-21	FERRITE	OuH	R119	1-216-833-11	METAL CHIP	10K 5% 1/16W
FB112	1-469-784-11	FERRITE	OuH	R121	1-216-833-11	METAL CHIP	10K 5% 1/16W
		< FILTER >		R123	1-216-833-11	METAL CHIP	10K 5% 1/16W
FL101	1-234-177-21	FILTER, CHIP EMI		R124	1-216-797-11	METAL CHIP	10 5% 1/16W
FL102	1-234-177-21	FILTER, CHIP EMI		R125	1-216-797-11	METAL CHIP	10 5% 1/16W
FL103	1-234-177-21	FILTER, CHIP EMI		R126	1-216-797-11	METAL CHIP	10 5% 1/16W
FL104	1-233-893-21	FILTER, CHIP EMI		R127	1-216-797-11	METAL CHIP	10 5% 1/16W
FL105	1-234-177-21	FILTER, CHIP EMI		R128	1-216-827-11	METAL CHIP	3.3K 5% 1/16W
FL106	1-234-177-21	FILTER, CHIP EMI		R129	1-216-833-11	METAL CHIP	10K 5% 1/16W
FL108	1-234-177-21	FILTER, CHIP EMI		R130	1-216-833-11	METAL CHIP	10K 5% 1/16W
FL201	1-234-177-21	FILTER, CHIP EMI		R133	1-216-833-11	METAL CHIP	10K 5% 1/16W
FL501	1-234-177-21	FILTER, CHIP EMI		R134	1-216-833-11	METAL CHIP	10K 5% 1/16W
FL502	1-234-177-21	FILTER, CHIP EMI		R136	1-216-797-11	METAL CHIP	10 5% 1/16W
FL505	1-234-177-21	FILTER, CHIP EMI		R137	1-216-797-11	METAL CHIP	10 5% 1/16W
		< IC >		R138	1-216-797-11	METAL CHIP	10 5% 1/16W
IC101	8-759-640-41	IC BR24C08F-E2		R141	1-216-797-11	METAL CHIP	10 5% 1/16W
IC102	8-759-831-81	IC IMIC6001BTD (AEP, UK, RUS)		R142	1-216-797-11	METAL CHIP	10 5% 1/16W
IC102	8-759-831-82	IC SM8707AV-E2 (EXCEPT AEP, UK, RUS)		R143	1-216-833-11	METAL CHIP	10K 5% 1/16W
IC103	8-759-829-75	IC MB91307APFV-G-BND-E1		R145	1-216-833-11	METAL CHIP	10K 5% 1/16W
IC107	Note			R146	1-216-833-11	METAL CHIP	10K 5% 1/16W
IC108	Note			R149	1-216-827-11	METAL CHIP	3.3K 5% 1/16W
IC202	8-759-828-02	IC SP3728AC		R150	1-216-041-00	METAL CHIP	470 5% 1/10W (AUS)
IC301	8-759-832-31	IC TK71533ASCL		R150	1-216-047-00	RES-CHIP	820 5% 1/10W (EA, ME)
IC302	8-759-828-01	IC CXD9635R		R150	1-216-052-00	METAL CHIP	1.3K 5% 1/10W (E12)
IC303	8-759-643-10	IC GM71V18160CT-6TR		R150	1-216-057-00	METAL CHIP	2.2K 5% 1/10W (HK, KR, SP, TW)
IC401	8-759-826-42	IC FAN8034		R150	1-216-065-00	RES-CHIP	4.7K 5% 1/10W (RUS)
IC501	8-759-832-30	IC TK71518ASCL		R150	1-216-069-00	METAL CHIP	6.8K 5% 1/10W (AEP (DPX1402BM) AEP (DPX1402HM))
IC502	8-759-599-45	IC MM1385ENLE		R150	1-216-075-00	METAL CHIP	12K 5% 1/10W (AEP (DPX1401BM) AEP (DPX1401HM), UK)
IC503	8-752-409-87	IC CXD1933Q		R150	1-216-081-00	METAL CHIP	22K 5% 1/10W (MX, AR, BR, E32)
IC504	8-759-683-76	IC K4S161622D-TC80T		R151	1-216-827-11	METAL CHIP	3.3K 5% 1/16W
IC505	8-759-683-76	IC K4S161622D-TC80T (EXCEPT US, CND, MX, AR, BR, E32, PX)		R153	1-216-827-11	METAL CHIP	3.3K 5% 1/16W
IC601	8-759-826-43	IC CXD9631Q		R154	1-216-069-00	METAL CHIP	6.8K 5% 1/10W (E12, RUS)
IC801	8-759-825-34	IC CXD9626Q		R154	1-216-075-00	METAL CHIP	12K 5% 1/10W (MX, AR, AUS, BR, E32)
IC802	8-759-825-32	IC CXD9627N-E2		R154	1-216-081-00	METAL CHIP	22K 5% 1/10W (HK, KR, SP, TW)
		< COIL >		R154	1-216-089-11	RES-CHIP	47K 5% 1/10W (AEP, UK, EA, ME)
L201	1-412-031-11	INDUCTOR CHIP	47uH	R155	1-216-827-11	METAL CHIP	3.3K 5% 1/16W
		< TRANSISTOR >		R156	1-216-833-11	METAL CHIP	10K 5% 1/16W
Q201	8-729-903-46	TRANSISTOR	2SB1132-T100-QR	R160	1-216-833-11	METAL CHIP	10K 5% 1/16W
		< RESISTOR >		R163	1-216-833-11	METAL CHIP	10K 5% 1/16W
R101	1-216-789-11	METAL CHIP	2.2 5% 1/16W	R164	1-216-809-11	METAL CHIP	100 5% 1/16W
R106	1-216-833-11	METAL CHIP	10K 5% 1/16W	R165	1-216-809-11	METAL CHIP	100 5% 1/16W
R107	1-216-821-11	METAL CHIP	1K 5% 1/16W (AEP, UK, RUS)	R166	1-216-817-11	METAL CHIP	470 5% 1/16W
R107	1-216-864-91	SHORT	0 (EXCEPT AEP, UK, RUS)	R167	1-216-864-91	SHORT	0
R109	1-216-797-11	METAL CHIP	10 5% 1/16W	R168	1-216-864-91	SHORT	0
R111	1-216-817-11	METAL CHIP	470 5% 1/16W				
R112	1-216-821-11	METAL CHIP	1K 5% 1/16W				
R113	1-216-833-11	METAL CHIP	10K 5% 1/16W				
R114	1-216-845-11	METAL CHIP	100K 5% 1/16W				

Note: Part number has not been determined yet. It will be noticed later.

Ref. No.	Part No.	Description			Remark	Ref. No.	Part No.	Description			Remark
R170	1-216-821-11	METAL CHIP	1K	5%	1/16W	R351	1-216-825-11	METAL CHIP	2.2K	5%	1/16W
R177	1-216-797-11	METAL CHIP	10	5%	1/16W	R352	1-216-825-11	METAL CHIP	2.2K	5%	1/16W
R178	1-216-797-11	METAL CHIP	10	5%	1/16W	R356	1-218-853-11	METAL CHIP	1.8K	0.5%	1/16W
R182	1-216-845-11	METAL CHIP	100K	5%	1/16W	R368	1-216-829-11	METAL CHIP	4.7K	5%	1/16W
R199	1-216-826-11	METAL CHIP	2.7K	5%	1/16W	R384	1-216-797-11	METAL CHIP	10	5%	1/16W
R201	1-216-815-11	METAL CHIP	330	5%	1/16W	R385	1-216-829-11	METAL CHIP	4.7K	5%	1/16W
R202	1-216-809-11	METAL CHIP	100	5%	1/16W	R402	1-216-833-11	METAL CHIP	10K	5%	1/16W
R203	1-216-809-11	METAL CHIP	100	5%	1/16W	R403	1-216-833-11	METAL CHIP	10K	5%	1/16W
R204	1-216-837-11	METAL CHIP	22K	5%	1/16W	R404	1-216-821-11	METAL CHIP	1K	5%	1/16W
R205	1-216-845-11	METAL CHIP	100K	5%	1/16W	R405	1-216-821-11	METAL CHIP	1K	5%	1/16W
R206	1-216-838-11	METAL CHIP	27K	5%	1/16W	R406	1-216-846-11	METAL CHIP	120K	5%	1/16W
R207	1-216-803-11	METAL CHIP	33	5%	1/16W	R407	1-216-846-11	METAL CHIP	120K	5%	1/16W
R208	1-216-803-11	METAL CHIP	33	5%	1/16W	R408	1-216-847-11	METAL CHIP	150K	5%	1/16W
R209	1-216-820-11	METAL CHIP	820	5%	1/16W	R409	1-216-847-11	METAL CHIP	150K	5%	1/16W
R210	1-216-841-11	METAL CHIP	47K	5%	1/16W	R410	1-216-842-11	METAL CHIP	56K	5%	1/16W
R211	1-216-809-11	METAL CHIP	100	5%	1/16W	R411	1-216-842-11	METAL CHIP	56K	5%	1/16W
R213	1-216-864-91	SHORT	0			R412	1-216-850-11	METAL CHIP	270K	5%	1/16W
R214	1-216-864-91	SHORT	0			R413	1-216-833-11	METAL CHIP	10K	5%	1/16W
R217	1-216-864-91	SHORT	0			R414	1-216-853-11	METAL CHIP	470K	5%	1/16W
R218	1-216-864-91	SHORT	0			R415	1-216-846-11	METAL CHIP	120K	5%	1/16W
R224	1-216-801-11	METAL CHIP	22	5%	1/16W	R416	1-216-855-11	METAL CHIP	680K	5%	1/16W
R237	1-216-834-11	METAL CHIP	12K	5%	1/16W	R417	1-216-833-11	METAL CHIP	10K	5%	1/16W
R238	1-216-861-11	METAL CHIP	2.2M	5%	1/16W	R418	1-216-839-11	METAL CHIP	33K	5%	1/16W
R245	1-216-811-11	METAL CHIP	150	5%	1/16W	R419	1-216-839-11	METAL CHIP	33K	5%	1/16W
R246	1-216-827-11	METAL CHIP	3.3K	5%	1/16W	R420	1-216-853-11	METAL CHIP	470K	5%	1/16W
R299	1-216-847-11	METAL CHIP	150K	5%	1/16W	R421	1-216-839-11	METAL CHIP	33K	5%	1/16W
R301	1-216-827-11	METAL CHIP	3.3K	5%	1/16W	R422	1-216-839-11	METAL CHIP	33K	5%	1/16W
R302	1-216-827-11	METAL CHIP	3.3K	5%	1/16W	R423	1-216-839-11	METAL CHIP	33K	5%	1/16W
R305	1-216-829-11	METAL CHIP	4.7K	5%	1/16W	R424	1-216-839-11	METAL CHIP	33K	5%	1/16W
R306	1-216-829-11	METAL CHIP	4.7K	5%	1/16W	R425	1-216-849-11	METAL CHIP	220K	5%	1/16W
R307	1-216-829-11	METAL CHIP	4.7K	5%	1/16W	R426	1-216-853-11	METAL CHIP	470K	5%	1/16W
R308	1-216-829-11	METAL CHIP	4.7K	5%	1/16W	R427	1-218-895-11	METAL CHIP	100K	0.5%	1/16W
R309	1-216-829-11	METAL CHIP	4.7K	5%	1/16W	R428	1-216-839-11	METAL CHIP	33K	5%	1/16W
R310	1-216-829-11	METAL CHIP	4.7K	5%	1/16W	R429	1-218-889-11	METAL CHIP	56K	0.5%	1/16W
R311	1-216-829-11	METAL CHIP	4.7K	5%	1/16W	R430	1-218-895-11	METAL CHIP	100K	0.5%	1/16W
R312	1-216-829-11	METAL CHIP	4.7K	5%	1/16W	R431	1-218-889-11	METAL CHIP	56K	0.5%	1/16W
R313	1-216-817-11	METAL CHIP	470	5%	1/16W	R432	1-216-833-11	METAL CHIP	10K	5%	1/16W
R314	1-216-817-11	METAL CHIP	470	5%	1/16W	R433	1-216-833-11	METAL CHIP	10K	5%	1/16W
R315	1-216-817-11	METAL CHIP	470	5%	1/16W	R434	1-216-815-11	METAL CHIP	330	5%	1/16W
R316	1-216-829-11	METAL CHIP	4.7K	5%	1/16W	R435	1-216-833-11	METAL CHIP	10K	5%	1/16W
R317	1-216-833-11	METAL CHIP	10K	5%	1/16W	R436	1-216-809-11	METAL CHIP	100	5%	1/16W
R318	1-216-295-11	SHORT	0			R439	1-216-864-91	SHORT	0		
R319	1-216-831-11	METAL CHIP	6.8K	5%	1/16W	R507	1-216-809-11	METAL CHIP	100	5%	1/16W
R320	1-216-295-11	SHORT	0			R510	1-216-833-11	METAL CHIP	10K	5%	1/16W
R321	1-216-817-11	METAL CHIP	470	5%	1/16W	R511	1-218-831-11	METAL CHIP	220	0.5%	1/16W
R328	1-216-833-11	METAL CHIP	10K	5%	1/16W	R512	1-218-831-11	METAL CHIP	220	0.5%	1/16W
R329	1-216-295-11	SHORT	0			R513	1-218-831-11	METAL CHIP	220	0.5%	1/16W
R330	1-216-295-11	SHORT	0			R514	1-218-831-11	METAL CHIP	220	0.5%	1/16W
R334	1-218-871-11	METAL CHIP	10K	0.5%	1/16W	R515	1-218-831-11	METAL CHIP	220	0.5%	1/16W
R335	1-218-855-11	METAL CHIP	2.2K	0.5%	1/16W	R516	1-218-831-11	METAL CHIP	220	0.5%	1/16W
R336	1-216-833-11	METAL CHIP	10K	5%	1/16W	R517	1-216-833-11	METAL CHIP	10K	5%	1/16W
R337	1-216-809-11	METAL CHIP	100	5%	1/16W	R518	1-216-822-11	METAL CHIP	1.2K	5%	1/16W
R338	1-218-879-11	METAL CHIP	22K	0.5%	1/16W	R519	1-216-295-11	SHORT	0		
R341	1-218-871-11	METAL CHIP	10K	0.5%	1/16W	R521	1-216-295-11	SHORT	0		
R342	1-218-883-11	METAL CHIP	33K	0.5%	1/16W	R522	1-216-827-11	METAL CHIP	3.3K	5%	1/16W
R343	1-218-831-11	METAL CHIP	220	0.5%	1/16W	R524	1-216-833-11	METAL CHIP	10K	5%	1/16W
R344	1-218-847-11	METAL CHIP	1K	0.5%	1/16W	R525	1-216-833-11	METAL CHIP	10K	5%	1/16W
R345	1-216-833-11	METAL CHIP	10K	5%	1/16W	R533	1-216-797-11	METAL CHIP	10	5%	1/16W
R349	1-216-838-11	METAL CHIP	27K	5%	1/16W	R554	1-216-797-11	METAL CHIP	10	5%	1/16W
R350	1-216-822-11	METAL CHIP	1.2K	5%	1/16W	R604	1-216-809-11	METAL CHIP	100	5%	1/16W

Ref. No.	Part No.	Description	Remark
R701	1-216-864-91	SHORT	0
R801	1-216-864-91	SHORT	0
R803	1-216-864-91	SHORT	0
R804	1-216-864-91	SHORT	0
R805	1-216-809-11	METAL CHIP	100 5% 1/16W
R807	1-216-864-91	SHORT	0
R808	1-216-864-91	SHORT	0
< VARIABLE RESISTOR >			
RV501	1-223-583-11	RES, ADJ, CARBON 1K (VIDEO LEVEL ADJ)	
< VIBRATOR >			
X101	1-795-174-11	VIBRATOR, CERAMIC (16.5 MHz)	
X102	1-781-867-21	VIBRATOR, CRYSTAL (27 MHz)	
MS-81 BOARD ***** (Ref. No. 1,000 Series)			
< CONNECTOR >			
CN001	1-815-412-11	CONNECTOR, FFC/FPC 5P	
< SWITCH >			
S001	1-786-133-11	SWITCH, ROTARY (CHUCK/TRAY DETECT)	
***** (Ref. No. 3,000 Series)			
< CAPACITOR >			
△ C101	1-115-165-11	FILM	0.1uF 250V
△ C102	1-115-165-11	FILM	0.1uF 250V
△ C103	1-127-942-11	CERAMIC	330PF 250V
△ C104	1-127-942-11	CERAMIC	330PF 250V
△ C107	1-127-942-11	CERAMIC	330PF 250V
C110	9-885-012-88	ELECT	47uF 400V
C115	1-130-483-11	FILM	0.01uF 50V
C116	1-130-483-11	FILM	0.01uF 50V
C117	1-130-477-11	FILM	0.0033uF 50V
C150	9-885-012-89	CERAMIC	47PF 2KV
C211	1-111-083-11	ELECT	150uF 35V
C213	1-126-947-11	ELECT	47uF 35V
C221	1-111-082-11	ELECT	100uF 35V
C223	1-126-947-11	ELECT	47uF 35V
C301	1-126-960-11	ELECT	1uF 50V
C311	1-111-087-11	ELECT	330uF 35V
C313	1-126-947-11	ELECT	47uF 35V
C314	1-126-965-11	ELECT	22uF 50V
C413	1-126-947-11	ELECT	47uF 35V
C414	1-130-483-11	FILM	0.01uF 50V
C511	1-111-082-11	ELECT	100uF 35V
C513	1-126-947-11	ELECT	47uF 35V
C611	1-111-087-11	ELECT	330uF 35V
C613	1-126-947-11	ELECT	47uF 35V

Ref. No.	Part No.	Description	Remark
C711	1-126-947-11	ELECT	47uF 35V
< CONNECTOR >			
△ CN101	1-580-230-11	CONNECTOR 2P	
* CN201	1-778-318-21	CONNECTOR 13P	
< DIODE >			
△ D101	9-885-000-79	DIODE S1WBA60	
D102	8-719-160-78	DIODE RD24FB2	
D104	8-719-109-66	DIODE RD3.3ES-B2	
D105	9-903-904-01	DIODE 1SS270A	
D211	8-719-018-84	DIODE D2S6M	
D212	8-719-160-87	DIODE RD33FB2	
D221	8-719-032-12	DIODE D1NS6	
D311	8-719-510-02	DIODE D1NS4	
D413	9-998-285-01	DIODE D1N60	
D511	8-719-063-69	DIODE D2L20U	
D611	8-719-510-02	DIODE D1NS4	
D621	8-719-064-11	DIODE SPR-325MVW (ON/STANDBY)	
< FUSE >			
△ F101	1-532-388-31	FUSE (2A/250V)	
< FUSE CLIP >			
FC1	9-885-012-77	FUSE CLIP	
FC2	9-885-012-77	FUSE CLIP	
< EARTH TERMINAL >			
FG101	1-537-738-21	TERMINAL, EARTH	
FG201	1-537-738-21	TERMINAL, EARTH	
< IC >			
IC301	8-759-420-19	IC AN1431T	
IC411	8-759-420-19	IC AN1431T	
< COIL >			
△ L101	9-885-012-78	LINE FILTER	18mH
△ L102	9-885-012-78	LINE FILTER	18mH
L150	9-885-012-79	BEAD CORE	120
L211	9-885-012-80	COIL, CHOKE	39uH
L221	9-885-012-81	COIL, CHOKE	100uH
L311	9-885-012-80	COIL, CHOKE	39uH
L511	9-885-012-81	COIL, CHOKE	100uH
L611	9-885-012-80	COIL, CHOKE	39uH
< IC LINK >			
△ P311	9-885-012-82	LINK, IC (1A/60V)	
△ P611	9-885-012-82	LINK, IC (1A/60V)	
< PHOTO COUPLER >			
△ PC101	8-749-011-50	PHOTO COUPLER PS2561	
< TRANSISTOR >			
Q101	9-885-006-12	TRANSISTOR	2SK2700
Q102	8-729-023-98	TRANSISTOR	2SC3377
Q211	9-885-005-96	TRANSISTOR	2SJ525

The components identified by mark △ or dotted line with mark △ are critical for safety. Replace only with part number specified.

Les composants identifiés par une marque △ sont critiques pour la sécurité. Ne les remplacer que par une pièce portant le numéro spécifié.

POWER BLOCK (HS13S0F)

POWER BLOCK (HS13S0E)

Ref. No.	Part No.	Description	Remark	Ref. No.	Part No.	Description	Remark
Q311	9-885-006-08	TRANSISTOR	2SD1768S	* CN201	1-778-318-21	CONNECTOR 13P	
Q411	9-885-006-08	TRANSISTOR	2SD1768S			< DIODE >	
Q611	9-885-006-08	TRANSISTOR	2SD1768S	△ D101	9-885-000-79	DIODE S1WBA60	
Q621	8-729-901-41	TRANSISTOR	2SC1740S	D102	8-719-160-78	DIODE RD24FB2	
Q622	8-729-029-92	TRANSISTOR	DTC143ES	D104	8-719-981-98	DIODE MTZJ-3.0B	
Q712	8-729-029-92	TRANSISTOR	DTC143ES	D105	9-903-904-01	DIODE 1SS270A	
		< RESISTOR >		D131	9-903-904-01	DIODE 1SS270A	
R101	1-219-776-11	CARBON	2.2M	1/2W	D132	8-719-922-11	DIODE MTZJ-22B
R105	1-219-774-11	CARBON	1M	1/2W	D135	8-719-030-24	DIODE EG01C
		< SWITCH >		D211	8-719-018-84	DIODE D2S6M	
△ SW101	9-885-012-83	SWITCH (POWER)		D212	8-719-160-87	DIODE RD33FB2	
		< TRANSFORMER >		D221	8-719-032-12	DIODE D1NS6	
△ T101	9-885-012-90	TRANSFORMER		D311	8-719-510-02	DIODE D1NS4	
				D411	8-719-510-02	DIODE D1NS4	
				D511	8-719-063-69	DIODE D2L20U	
				D611	8-719-510-02	DIODE D1NS4	
				D615	8-719-064-11	DIODE SPR-325MVW (ON/STANDBY)	
*	1-468-586-11	POWER BLOCK (HS13S0F) (BR, E32, PX)				< FUSE >	
		*****		△ F101	1-532-503-31	FUSE (1.6A/250V)	
		(Ref. No. 4,000 Series)				< FUSE CLIP >	
		< CAPACITOR >		FC1	9-885-012-77	FUSE CLIP	
△ C101	1-115-165-11	FILM	0.1uF	250V	FC2	9-885-012-77	FUSE CLIP
△ C103	1-127-942-11	CERAMIC	330PF	250V			< EARTH TERMINAL >
△ C104	1-127-942-11	CERAMIC	330PF	250V	FG101	1-537-738-21	TERMINAL, EARTH
△ C107	1-127-942-11	CERAMIC	330PF	250V	FG201	1-537-738-21	TERMINAL, EARTH
C110	9-885-012-91	ELECT	150uF	400V			< IC >
C112	9-885-012-92	FILM	0.047uF	630V	IC131	9-885-005-97	IC MIP0254SPSCF
C113	9-885-012-89	CERAMIC	47PF	2KV	IC401	8-759-667-11	IC HA17L431P
C115	1-130-489-11	FILM	0.033uF	50V	IC701	8-759-420-19	IC AN1431T
C116	1-130-483-11	FILM	0.01uF	50V			< COIL >
C117	1-130-477-11	FILM	0.0033uF	50V	△ L101	9-885-012-78	LINE FILTER 18mH
C131	1-126-966-11	ELECT	33uF	50V	△ L102	9-885-012-78	LINE FILTER 18mH
C132	1-126-960-11	ELECT	1uF	50V	L150	9-885-012-96	BEAD CORE 45
C135	9-885-012-93	CERAMIC	3300PF	1KV	L211	9-885-012-80	COIL, CHOKE 39uH
C137	9-885-012-94	FILM	0.1uF	50V	L221	9-885-012-81	COIL, CHOKE 100uH
C211	1-111-083-11	ELECT	150uF	35V	L311	9-885-012-81	COIL, CHOKE 100uH
C213	1-126-947-11	ELECT	47uF	35V	L411	9-885-012-80	COIL, CHOKE 39uH
C221	1-111-082-11	ELECT	100uF	35V	L511	9-885-012-81	COIL, CHOKE 100uH
C223	1-126-947-11	ELECT	47uF	35V	L611	9-885-012-81	COIL, CHOKE 100uH
C311	9-885-012-95	ELECT	150uF	35V			< IC LINK >
C313	1-126-947-11	ELECT	47uF	35V	△ P311	9-885-012-82	LINK, IC (1A/60V)
C314	1-126-965-11	ELECT	22uF	50V	△ P611	9-885-012-82	LINK, IC (1A/60V)
C401	9-885-012-95	ELECT	150uF	35V			< PHOTO COUPLER >
C402	1-126-959-11	ELECT	0.47uF	50V	△ PC101	8-749-011-50	PHOTO COUPLER PS2561
C413	1-126-947-11	ELECT	47uF	35V	△ PC103	8-749-011-50	PHOTO COUPLER PS2561
C511	1-111-082-11	ELECT	100uF	35V	△ PC131	8-749-011-50	PHOTO COUPLER PS2561
C512	1-111-082-11	ELECT	100uF	35V			< TRANSISTOR >
C611	9-885-012-95	ELECT	150uF	35V	Q101	9-885-006-10	TRANSISTOR 2SK2750
C613	1-126-947-11	ELECT	47uF	35V			
C701	1-126-963-11	ELECT	4.7uF	50V			
C703	1-126-960-11	ELECT	1uF	50V			
C711	1-126-947-11	ELECT	47uF	35V			
		< CONNECTOR >					
△ CN101	1-580-230-11	CONNECTOR 2P					

The components identified by mark △ or dotted line with mark △ are critical for safety. Replace only with part number specified.

Les composants identifiés par une marque △ sont critiques pour la sécurité. Ne les remplacer que par une pièce portant le numéro spécifié.

POWER BLOCK (HS13S0F)

POWER BLOCK (HS13S0U)

Ref. No.	Part No.	Description	Remark
Q102	8-729-023-98	TRANSISTOR 2SC3377	
Q103	9-885-006-10	TRANSISTOR 2SK2750	
Q131	9-885-006-08	TRANSISTOR 2SD1768S	
Q311	9-885-006-08	TRANSISTOR 2SD1768S	
Q621	8-729-901-41	TRANSISTOR 2SC1740S	
Q622	8-729-029-92	TRANSISTOR DTC143ES	
Q712	8-729-029-92	TRANSISTOR DTC143ES	
< RESISTOR >			
R101	1-219-776-11	CARBON 2.2M	1/2W
R104	9-885-012-97	CARBON 680K	1/2W
< SWITCH >			
△SW101	9-885-012-83	SWITCH (POWER)	
< TRANSFORMER >			
△T101	9-885-012-98	TRANSFORMER	
△T131	9-885-012-99	TRANSFORMER	
*	1-468-583-11	POWER BLOCK (HS13S0U) (US, CND, MX, TW) ***** (Ref. No. 5,000 Series)	
< CAPACITOR >			
△C101	1-115-165-11	FILM 0.1uF	250V
△C107	1-113-937-11	CERAMIC 2200PF	250V
C110	9-885-012-85	ELECT 120uF	200V
C115	1-130-489-11	FILM 0.033uF	50V
C116	1-130-483-11	FILM 0.01uF	50V
C117	1-130-477-11	FILM 0.0033uF	50V
C150	9-885-012-86	CERAMIC 470PF	1KV
C211	1-111-083-11	ELECT 150uF	35V
C213	1-126-947-11	ELECT 47uF	35V
C221	1-111-082-11	ELECT 100uF	35V
C223	1-126-947-11	ELECT 47uF	35V
C301	1-126-961-11	ELECT 2.2uF	50V
C311	1-111-087-11	ELECT 330uF	35V
C313	1-126-947-11	ELECT 47uF	35V
C314	1-126-965-11	ELECT 22uF	50V
C413	1-126-947-11	ELECT 47uF	35V
C414	1-130-483-11	FILM 0.01uF	50V
C511	1-111-082-11	ELECT 100uF	35V
C513	1-126-947-11	ELECT 47uF	35V
C611	1-111-087-11	ELECT 330uF	35V
C613	1-126-947-11	ELECT 47uF	35V
C711	1-126-947-11	ELECT 47uF	35V
< CONNECTOR >			
△CN101	1-580-230-11	CONNECTOR 2P	
* CN201	1-778-318-21	CONNECTOR 13P	
< DIODE >			
△D101	9-885-000-79	DIODE S1WBA60	
D104	8-719-062-66	DIODE HZS2C3-TE	
D105	9-903-904-01	DIODE 1SS270A	

Ref. No.	Part No.	Description	Remark
D211	8-719-018-83	DIODE D2S4M	
D212	8-719-160-87	DIODE RD33FB2	
D221	8-719-510-02	DIODE D1NS4	
D311	8-719-510-02	DIODE D1NS4	
D413	9-998-285-01	DIODE D1N60	
D511	8-719-510-02	DIODE D1NS4	
D611	8-719-510-02	DIODE D1NS4	
D621	8-719-064-11	DIODE SPR-325MVW (ON/STANDBY)	
< FUSE >			
△F101	1-533-296-11	FUSE (2A/125V)	
< FUSE CLIP >			
FC1	9-885-012-77	FUSE CLIP	
FC2	9-885-012-77	FUSE CLIP	
< EARTH TERMINAL >			
FG101	1-537-738-21	TERMINAL, EARTH	
FG201	1-537-738-21	TERMINAL, EARTH	
< IC >			
IC301	8-759-420-19	IC AN1431T	
IC411	8-759-420-19	IC AN1431T	
< COIL >			
△L101	9-885-012-78	LINE FILTER	18mH
L150	9-885-012-79	BEAD CORE	120
L211	9-885-012-80	COIL, CHOKE	39uH
L221	9-885-012-81	COIL, CHOKE	100uH
L311	9-885-012-80	COIL, CHOKE	39uH
L511	9-885-012-81	COIL, CHOKE	100uH
L611	9-885-012-80	COIL, CHOKE	39uH
< IC LINK >			
△P311	9-885-012-82	LINK, IC (1A/60V)	
△P611	9-885-012-82	LINK, IC (1A/60V)	
< PHOTO COUPLER >			
△PC101	9-995-566-01	PHOTO COUPLER PS2501	
< TRANSISTOR >			
Q101	9-885-006-10	TRANSISTOR 2SK2750	
Q102	8-729-023-98	TRANSISTOR 2SC3377	
Q211	9-885-005-96	TRANSISTOR 2SJ525	
Q311	9-885-006-08	TRANSISTOR 2SD1768S	
Q411	9-885-006-08	TRANSISTOR 2SD1768S	
Q611	9-885-006-08	TRANSISTOR 2SD1768S	
Q621	8-729-901-41	TRANSISTOR 2SC1740S	
Q622	8-729-029-92	TRANSISTOR DTC143ES	
Q712	8-729-029-92	TRANSISTOR DTC143ES	
< SWITCH >			
△SW101	9-885-012-83	SWITCH (POWER)	

The components identified by mark △ or dotted line with mark △ are critical for safety. Replace only with part number specified.

Les composants identifiés par une marque △ sont critiques pour la sécurité. Ne les remplacer que par une pièce portant le numéro spécifié.

POWER BLOCK (HS13S0U)

POWER BLOCK (TOP-244U)

Ref. No.	Part No.	Description	Remark
		< TRANSFORMER >	
△ T101	9-885-012-87	TRANSFORMER	
* 1-468-584-11		POWER BLOCK (TOP-244U) (US, CND, MX) ***** (Ref.No. 6,000 Series)	
		< CAPACITOR >	
△ C900	1-115-165-11	FILM 0.1uF	250V
△ C901	1-113-920-51	CERAMIC 2200PF	250V
△ C902	1-113-906-51	CERAMIC 330PF	250V
△ C903	1-113-906-51	CERAMIC 330PF	250V
C910	1-107-401-11	ELECT 150uF	200V
△ C911	9-885-013-00	FILM 0.01uF	400V
C912	9-885-013-01	FILM 0.1uF	50V
C913	9-885-013-02	ELECT 47uF	25V
C914	9-885-013-03	ELECT 10uF	50V
△ C916	9-885-013-00	FILM 0.01uF	400V
C917	9-885-013-04	CERAMIC 4700PF	50V
C920	9-885-013-01	FILM 0.1uF	50V
C921	9-885-013-05	ELECT 470uF	25V
C922	9-885-013-04	CERAMIC 4700PF	50V
C924	9-885-013-05	ELECT 470uF	25V
C925	9-885-013-06	ELECT 100uF	25V
C926	9-885-013-01	FILM 0.1uF	50V
C927	9-885-013-07	ELECT 1000uF	16V
C929	9-885-013-06	ELECT 100uF	25V
C930	9-885-013-03	ELECT 10uF	50V
C931	9-885-013-06	ELECT 100uF	25V
C934	9-885-013-03	ELECT 10uF	50V
C936	9-885-013-02	ELECT 47uF	25V
C940	9-885-013-05	ELECT 470uF	25V
C941	9-885-013-05	ELECT 470uF	25V
C943	9-885-013-01	FILM 0.1uF	50V
C944	9-885-013-01	FILM 0.1uF	50V
C945	9-885-013-01	FILM 0.1uF	50V
C947	9-885-013-01	FILM 0.1uF	50V
		< CONNECTOR >	
△ CN900	1-580-230-11	CONNECTOR 2P	
* CN920	1-778-318-21	CONNECTOR 13P	
		< DIODE >	
△ D901	9-885-013-08	DIODE 1N4007	
△ D902	9-885-013-08	DIODE 1N4007	
△ D903	9-885-013-08	DIODE 1N4007	
△ D904	9-885-013-08	DIODE 1N4007	
D910	9-885-013-09	DIODE UF4007	
D911	9-885-013-10	DIODE 1N4001	
D913	9-885-013-11	DIODE P6KE200A	
D920	9-885-013-12	DIODE UF202G	
D921	9-885-013-13	DIODE UF4003	
D922	9-885-013-14	DIODE UF5402G	
D923	9-885-013-13	DIODE UF4003	
D925	8-719-983-18	DIODE MTZJ-4.3A	
D926	9-885-013-10	DIODE 1N4001	

Ref. No.	Part No.	Description	Remark
D927	9-885-013-10	DIODE 1N4001	
D928	9-885-013-10	DIODE 1N4001	
D929	8-719-064-11	DIODE SPR-325MVW (ON/STANDBY)	
D930	9-885-013-10	DIODE 1N4001	
D931	9-885-013-10	DIODE 1N4001	
D932	9-885-013-10	DIODE 1N4001	
D933	9-885-013-10	DIODE 1N4001	
		< EARTH TERMINAL >	
ET901	1-537-738-21	TERMINAL, EARTH	
ET902	1-537-738-21	TERMINAL, EARTH	
		< FUSE >	
△ F900	1-533-296-11	FUSE (2A/125V)	
		< FUSE HOLDER >	
FH900	1-533-399-31	HOLDER, FUSE	
FH901	1-533-399-31	HOLDER, FUSE	
		< IC >	
△ IC910	9-885-013-15	IC TOP-244Y	
IC920	9-885-013-16	IC TL431A	
		< COIL >	
L921	9-885-013-17	COIL, CHOKE 11.3uH	
L922	9-885-013-17	COIL, CHOKE 11.3uH	
L923	9-885-013-17	COIL, CHOKE 11.3uH	
L924	9-885-013-17	COIL, CHOKE 11.3uH	
		< LINE FILTER >	
△ LF900	1-416-929-11	COIL, CHOKE 2.3mH	
		< PHOTO COUPLER >	
△ PC910	8-749-010-65	PHOTO COUPLER PC123FY2	
△ PC911	8-749-010-65	PHOTO COUPLER PC123FY2	
		< IC LINK >	
△ PS922	1-533-590-31	LINK, IC (1A)	
△ PS923	1-533-591-31	LINK, IC (1.25A)	
		< TRANSISTOR >	
Q922	8-929-029-67	TRANSISTOR DTC114ESA-TP	
Q923	8-729-113-33	TRANSISTOR 2SB733-4	
Q924	8-729-012-32	TRANSISTOR 2SC4040-TL2-R	
Q925	8-729-012-32	TRANSISTOR 2SC4040-TL2-R	
Q927	8-729-012-32	TRANSISTOR 2SC4040-TL2-R	
Q928	8-729-018-57	TRANSISTOR DTA114GSTP	
Q929	8-729-925-12	TRANSISTOR 2SC1740SLN-TP-RS	
Q930	8-929-029-67	TRANSISTOR DTC114ESA-TP	
		< RESISTOR >	
R900	1-260-364-91	CARBON 1M	1/2W
R911	1-247-779-91	CARBON 6.8	1/4W
R917	1-247-863-91	CARBON 22K	1/4W
R921	1-247-831-91	CARBON 1K	1/4W
R922	1-247-807-91	CARBON 100	1/4W

The components identified by mark △ or dotted line with mark △ are critical for safety. Replace only with part number specified.	Les composants identifiés par une marque △ sont critiques pour la sécurité. Ne les remplacer que par une pièce portant le numéro spécifié.
--	--

POWER BLOCK (TOP-244U)

Ref. No.	Part No.	Description	Remark
R925	1-247-799-91	CARBON	47
R926	1-247-831-91	CARBON	1K
R927	1-247-859-91	CARBON	15K
R928	1-247-851-91	CARBON	6.8K
R930	1-247-855-91	CARBON	10K
R931	1-216-430-51	CARBON	390
R932	1-247-879-91	CARBON	100K
R933	1-247-851-91	CARBON	6.8K
R934	1-247-811-91	CARBON	150
R935	1-247-795-91	CARBON	33
R936	1-247-851-91	CARBON	6.8K
R938	1-247-811-91	CARBON	150
R940	1-247-815-91	CARBON	220
R947	1-247-815-91	CARBON	220
R948	1-247-831-91	CARBON	1K
R949	1-247-863-91	CARBON	22K
< SWITCH >			
△ SW911	9-885-012-83	SWITCH (POWER)	
< TRANSFORMER >			
△ T910	9-885-013-18	TRANSFORMER	
MISCELLANEOUS *****			
9	1-786-131-11	SWITCH, TACTILE	
11	1-476-602-11	REMOTE COMMANDER (RMT-D126A) (US, CND, E32, MX, AR, BR, PX)	
11	1-476-603-11	REMOTE COMMANDER (RMT-D126P) (AEP, UK, RUS)	
11	1-476-603-31	REMOTE COMMANDER (RMT-D126E) (E12, EA, ME, HK, KR, SP, TW, AUS)	
△ 56	1-757-140-11	CORD, POWER (AEP, UK, RUS, E12, E32, EA, ME, BR, HK, SP, PX)	
△ 56	1-757-571-11	CORD, POWER (US, CND, MX)	
△ 56	1-757-901-11	CORD, POWER (AR)	
△ 56	1-769-744-91	CORD, POWER (AEP, UK, RUS, E12, E32, EA, ME, BR, HK, SP, PX)	
△ 56	1-782-752-31	CORD, POWER (KR)	
△ 56	1-783-531-31	CORD, POWER (US, CND, MX)	
△ 56	1-790-390-41	CORD, POWER (TW)	
△ 56	1-790-588-11	CORD, POWER (AUS)	
62	1-757-695-11	CABLE, FLEXIBLE FLAT (FMA-023)	
63	1-757-693-11	CABLE, FLEXIBLE FLAT (FMO-001)	
64	1-757-694-11	CABLE, FLEXIBLE FLAT (FMO-002)	
65	1-757-697-11	CABLE, FLEXIBLE FLAT (FMM-035)	
72	1-757-699-11	CABLE, FLEXIBLE FLAT (FAE-005) (AEP, UK, RUS)	
△ 104	A-4900-650-A	OPTICAL PICK-UP KHM-250 AAA/J1NP	
M001	1-541-632-11	MOTOR, DC (LOADING)	

Ref. No.	Part No.	Description	Remark
ACCESSORIES & PACKING MATERIALS *****			
△	1-569-008-21	ADAPTOR, CONVERSION 2P (E32, EA, AR, BR, PX)	
	1-751-271-12	CORD, CONNECTION (STEREO AV CABLE 15m) (US, CND, AEP, UK, RUS, E12, E32, EA, MX, ME, AR, BR, HK, KR, SP, TW, AUS, PX)	
△	1-770-019-11	ADAPTOR, CONVERSION PLUG 3P (UK, HK)	
	3-067-116-11	MANUAL, INSTRUCTION (ENGLISH) (US (DPX1400BM), US (DPX1400HM), CND, PX)	
	3-067-116-21	MANUAL, INSTRUCTION (FRENCH) (CND)	
	3-067-116-31	MANUAL, INSTRUCTION (SPANISH) (E32, MX (DPX1400HM), AR, BR)	
	3-067-116-41	MANUAL, INSTRUCTION (ENGLISH) (E12, EA, ME, HK, KR, SP, TW, AUS)	
	3-067-116-51	MANUAL, INSTRUCTION (SIMPLIFIED CHINESE) (SP)	
	3-067-116-61	MANUAL, INSTRUCTION (TRADITIONAL CHINESE) (HK, TW)	
	3-067-116-71	MANUAL, INSTRUCTION (KOREAN) (KR)	
	3-067-116-81	MANUAL, INSTRUCTION (FRENCH) (E12)	
	3-067-116-91	MANUAL, INSTRUCTION (ARABIC) (EA, ME)	
	3-067-117-11	MANUAL, INSTRUCTION (ENGLISH) (UK, RUS)	
	3-067-117-21	MANUAL, INSTRUCTION (FRENCH) (AEP (DPX1401BM), AEP (DPX1401HM))	
	3-067-117-31	MANUAL, INSTRUCTION (GERMAN) (AEP (DPX1401BM), AEP (DPX1401HM))	
	3-067-117-41	MANUAL, INSTRUCTION (ITALIAN) (AEP)	
	3-067-117-51	MANUAL, INSTRUCTION (DUTCH) (AEP (DPX1401BM), AEP (DPX1401HM))	
	3-067-117-61	MANUAL, INSTRUCTION (RUSSIAN) (RUS)	
	3-067-118-11	MANUAL, INSTRUCTION (SPANISH) (AEP (DPX1402BM), AEP (DPX1402HM))	
	3-067-118-21	MANUAL, INSTRUCTION (PORTUGUESE) (AEP (DPX1402BM), AEP (DPX1402HM))	
	3-067-118-31	MANUAL, INSTRUCTION (DANISH) (AEP (DPX1402BM), AEP (DPX1402HM))	
	3-067-118-41	MANUAL, INSTRUCTION (FINNISH) (AEP (DPX1402BM), AEP (DPX1402HM))	
	3-067-118-51	MANUAL, INSTRUCTION (SWEDISH) (AEP (DPX1402BM), AEP (DPX1402HM))	
	3-067-119-11	MANUAL, INSTRUCTION (ENGLISH) (US (DPX1400BX))	
	3-067-119-21	MANUAL, INSTRUCTION (SPANISH) (MX (DPX1400HX))	

The components identified by mark △ or dotted line with mark △ are critical for safety. Replace only with part number specified.	Les composants identifiés par marque △ sont critiques pour la sécurité. Ne les remplacer que par une pièce portant le numéro spécifié.
--	--

